

Model 42i

Instruction Manual

Chemiluminescence NO-NO₂-NO_x Analyzer

Part Number 101350-00

25Jul2015



CE

Thermo
SCIENTIFIC

© 2007 Thermo Fisher Scientific Inc. All rights reserved.

Specifications, terms and pricing are subject to change. Not all products are available in all countries. Please consult your local sales representative for details.

Thermo Fisher Scientific
Air Quality Instruments
27 Forge Parkway
Franklin, MA 02038
1-508-520-0430
www.thermo.com/aqi

WEEE Compliance

This product is required to comply with the European Union's Waste Electrical & Electronic Equipment (WEEE) Directive 2002/96/EC. It is marked with the following symbol:



Thermo Fisher Scientific has contracted with one or more recycling/disposal companies in each EU Member State, and this product should be disposed of or recycled through them. Further information on Thermo Fisher Scientific's compliance with these Directives, the recyclers in your country, and information on Thermo Fisher Scientific products which may assist the detection of substances subject to the RoHS Directive are available at: www.thermo.com/WEEERoHS.

Reference Method Designation

The Thermo Scientific Model 42*i* is designated by the United States Environmental Protection Agency (US EPA) as a Reference Method for the measurement of ambient concentrations of nitrogen dioxide pursuant with the requirements defined in the Code of Federal Regulations, Title 40, Part 53.

Designated Reference Method Number: RFNA-1289-074

EPA Designation Date: December 11, 1989 (amended for Model 42*i*)

The Model 42*i* Chemiluminescence NO-NO₂-NO_x Analyzer meets EPA reference designation requirements when operated with the following:

Range	50 to 1000 ppb
Averaging Time	10 to 300 seconds
Temperature Range	15 to 35 °C
Line Voltage	90 to 110 Vac @50/60 Hertz 105 to 125 Vac @50/60 Hertz 210 to 250 Vac @50/60 Hertz
Pressure Compensation	ON or OFF
Temperature Compensation	ON or OFF
Flow Rate	0.5 to 1 LPM
RS-232/RS-485 Interface	

With or without the following options:

Teflon Particulate Filter
Ozone Particulate Filter
Internal Zero/Span and Sample Valves
Ozone Permeation Dryer
Permeation Oven
Rack Mounts
I/O Expansion Board

About This Manual

This manual provides information about operating, maintaining, and servicing the analyzer. It also contains important alerts to ensure safe operation and prevent equipment damage. The manual is organized into the following chapters and appendixes to provide direct access to specific operation and service information.

- Chapter 1 “[Introduction](#)” provides an overview of product features, describes the principles of operation, and lists the specifications.
- Chapter 2 “[Installation](#)” describes how to unpack, setup, and startup the analyzer.
- Chapter 3 “[Operation](#)” describes the front panel display, the front panel pushbuttons, and the menu-driven software.
- Chapter 4 “[Calibration](#)” provides the procedures for calibrating the analyzer and describes the required equipment.
- Chapter 5 “[Preventive Maintenance](#)” provides maintenance procedures to ensure reliable and consistent instrument operation.
- Chapter 6 “[Troubleshooting](#)” presents guidelines for diagnosing analyzer failures, isolating faults, and includes recommended actions for restoring proper operation.
- Chapter 7 “[Servicing](#)” presents safety alerts for technicians working on the analyzer, step-by-step instructions for repairing and replacing components, and a replacement parts list. It also includes contact information for product support and technical information.
- Chapter 8 “[System Description](#)” describes the function and location of the system components, provides an overview of the software structure, and includes a description of the system electronics and input/output connections.
- Chapter 9 “[Optional Equipment](#)” describes the optional equipment that can be used with this analyzer.
- Appendix A “[Warranty](#)” is a copy of the warranty statement.
- Appendix B “[C-Link Protocol Commands](#)” provides a description of the C-Link protocol commands that can be used to remotely control an analyzer using a host device such as a PC or datalogger.

- Appendix C “**MODBUS Protocol**” provides a description of the MODBUS Protocol Interface and is supported both over RS-232/485 (RTU protocol) as well as TCP/IP over Ethernet.
- Appendix D “**Geysitech (Bayern-Hessen) Protocol**” provides a description of the Geysitech (Bayern-Hessen or BH) Protocol Interface and is supported both over RS-232/485 as well as TCP/IP over Ethernet.





Safety

Review the following safety information carefully before using the analyzer. This manual provides specific information on how to operate the analyzer, however, if the analyzer is used in a manner not specified by the manufacturer, the protection provided by the equipment may be impaired.



Safety and Equipment Damage Alerts

This manual contains important information to alert you to potential safety hazards and risks of equipment damage. Refer to the following types of alerts you may see in this manual.

Safety and Equipment Damage Alert Descriptions

Alert	Description
 DANGER	A hazard is present that could result in death or serious personal injury if the warning is ignored. ▲
 WARNING	A hazard or unsafe practice could result in serious personal injury if the warning is ignored. ▲
 CAUTION	A hazard or unsafe practice could result in minor to moderate personal injury if the warning is ignored. ▲
 Equipment Damage	A hazard or unsafe practice could result in property damage if the warning is ignored. ▲

Safety and Equipment damage Alerts in this Manual

Alert	Description
 WARNING	<p>If the equipment is operated in a manner not specified by the manufacturer, the protection provided by the equipment may be impaired. ▲</p> <p>The service procedures in this manual are restricted to qualified service personnel only. ▲</p> <p>The Model 42i is supplied with a three-wire grounding cord. Under no circumstances should this grounding system be defeated. ▲</p>
 CAUTION	<p>If the LCD panel breaks, do not to let the liquid crystal contact your skin or clothes. If the liquid crystal contacts your skin or clothes, wash it off immediately using soap and water. ▲</p>
 Equipment Damage	<p>Do not attempt to lift the analyzer by the cover or other external fittings. ▲</p> <p>Some internal components can be damaged by small amounts of static electricity. A properly ground antistatic wrist strap must be worn while handling any internal component. ▲</p> <p>This adjustment should only be performed by an instrument service technician. ▲</p> <p>Handle all printed circuit boards by the edges only. ▲</p> <p>Do not remove the panel or frame from the LCD module. ▲</p> <p>The LCD module polarizing plate is very fragile, handle it carefully. ▲</p> <p>Do not wipe the LCD module polarizing plate with a dry cloth, it may easily scratch the plate. ▲</p> <p>Do not use Ketonics solvent or aromatic solvent to clean the LCD module, use a soft cloth moistened with a naphtha cleaning solvent. ▲</p> <p>Do not place the LCD module near organic solvents or corrosive gases. ▲</p> <p>Do not shake or jolt the LCD module. ▲</p>

FCC Compliance

Changes or modifications to this unit not expressly approved by the party responsible for compliance could void the user's authority to operate the equipment.

Note This equipment has been tested and found to comply with the limits for a Class A digital device, pursuant to Part 15 of the FCC Rules. These limits are designed to provide reasonable protection against harmful interference when the equipment is operated in a commercial environment. This equipment generates, uses, and can radiate radio frequency energy and, if not installed and used in accordance with the instruction manual, may cause harmful interference to radio communications. Operation of this equipment in a residential area is likely to cause harmful interference in which case the user will be required to correct the interference at his own expense. ▲

WEEE Symbol

The following symbol and description identify the WEEE marking used on the instrument and in the associated documentation.

Symbol	Description
	Marking of electrical and electronic equipment which applies to waste electrical and electronic equipment falling under the Directive 2002/96/EC (WEEE) and the equipment that has been put on the market after 13 August 2005. ▲

Where to Get Help

Service is available from exclusive distributors worldwide. Contact one of the phone numbers below for product support and technical information or visit us on the web at www.thermo.com/aqi.

1-866-282-0430 Toll Free

1-508-520-0430 International

Contents

Chapter 1	Introduction.....	1-1
	Principle of Operation	1-2
	Specifications	1-3
Chapter 2	Installation	2-1
	Lifting	2-1
	Unpacking and Inspection	2-1
	Setup Procedure	2-3
	Connecting External Devices	2-5
	Terminal Board PCB Assemblies.....	2-5
	I/O Terminal Board.....	2-5
	D/O Terminal Board	2-7
	25-Pin Terminal Board	2-8
	Startup	2-9
Chapter 3	Operation	3-1
	Display.....	3-1
	Pushbuttons	3-2
	Soft Keys.....	3-3
	Alphanumeric Entry Screen.....	3-4
	Firmware Overview	3-4
	Power-Up Screen	3-6
	Run Screen.....	3-6
	Main Menu.....	3-7
	Range Menu	3-8
	Single Range Mode	3-8
	Dual Range Mode.....	3-9
	Auto Range Mode.....	3-11
	Gas Units	3-13
	NO, NO ₂ , and NO _x Ranges.....	3-13
	Set Custom Ranges	3-15
	Custom Ranges	3-16
	Averaging Time.....	3-16
	Calibration Factors Menu	3-17
	NO and NO _x Backgrounds	3-17
	NO, NO ₂ , and NO _x Coefficients	3-19
	Reset User Calibration Defaults	3-19
	Calibration Menu	3-20
	Calibrate NO and NO _x Backgrounds.....	3-20

Calibrate NO, NO ₂ , and NO _x Coefficients	3-21
Zero/Span Check	3-21
Next Time	3-22
Period Hours.....	3-22
Total Duration Hour	3-23
Zero/Span/Purge Duration Minutes	3-23
Zero/Span Averaging Time	3-23
Zero/Span Calibration Reset	3-24
Zero/Span Ratio.....	3-24
Instrument Controls Menu	3-24
Ozonator.....	3-25
PMT Supply	3-26
Auto/Manual Mode	3-26
Datalogging Settings	3-26
Select Srec/Lrec	3-27
View Logged Data.....	3-28
Number of Records.....	3-28
Date and Time.....	3-28
Erase Log	3-29
Select Content.....	3-29
Choose Field Data.....	3-30
Concentrations.....	3-30
Other Measurements.....	3-31
Analog Inputs.....	3-32
Commit Content	3-32
Reset to Default Content	3-32
Configure Datalogging.....	3-33
Logging Period Min	3-33
Memory Allocation Percent.....	3-33
Data Treatment	3-34
Communication Settings.....	3-34
Serial Settings.....	3-35
Baud Rate	3-35
Data Bits.....	3-35
Parity	3-36
Stop Bits	3-36
RS-232/RS-485 Selection.....	3-36
Instrument ID.....	3-37
Communication Protocol.....	3-37
Streaming Data Configuration	3-38
Streaming Data Interval	3-38
Choose Stream Data	3-39
Concentrations.....	3-39
Other Measurements.....	3-40
Analog Inputs.....	3-40
TCP/IP Settings.....	3-41

Use DHCP	3-41
IP Address	3-42
Netmask.....	3-42
Default Gateway	3-42
Host Name	3-43
Network Time Protocol Server.....	3-43
I/O Configuration.....	3-43
Output Relay Settings	3-44
Logic State	3-44
Instrument State	3-45
Alarms.....	3-45
Non-Alarm	3-46
Digital Input Settings.....	3-47
Logic State	3-47
Instrument Action.....	3-48
Analog Output Configuration (Select Channel)	3-48
Allow Over/Under Range.....	3-48
Analog Output Configuration (Select Action)	3-49
Select Range.....	3-49
Minimum and Maximum Value	3-50
Choose Signal to Output	3-51
Analog Input Configuration.....	3-53
Descriptor	3-53
Units.....	3-54
Decimal Places	3-54
Number of Table Points.....	3-54
Table Point	3-55
Volts	3-55
User Value	3-56
Temperature Compensation.....	3-56
Pressure Compensation	3-57
Screen Contrast.....	3-57
Service Mode	3-58
Date/Time	3-58
Timezone.....	3-59
Diagnostics Menu	3-59
Program Version	3-60
Voltages	3-60
Motherboard Voltages.....	3-61
Interface Board Voltages	3-61
I/O Board Voltages	3-61
Temperatures	3-62
Pressure.....	3-62
Flow.....	3-62
Analog Input Readings.....	3-63
Analog Input Voltages.....	3-63

Digital Inputs.....	3-63
Relay States	3-64
Test Analog Outputs.....	3-64
Set Analog Outputs.....	3-64
Instrument Configuration	3-65
Contact Information	3-65
Alarms Menu	3-66
Internal Temperature	3-67
Min and Max Internal Temperature Limits.....	3-67
Chamber Temperature.....	3-67
Min and Max Chamber Temperature Limits	3-68
Cooler Temperature.....	3-68
Min and Max Cooler Temperature Limits	3-68
Converter Temperature.....	3-69
Min and Max Converter Temperature Limits	3-69
Permeation Oven Gas Temperature	3-69
Min and Max Permeation Oven Temperature Limits.....	3-70
Pressure.....	3-70
Min and Max Pressure Limits	3-71
Flow.....	3-71
Min and Max Flow Limits	3-71
Ozonator Flow.....	3-72
Zero and Span Check.....	3-72
Max Zero and Span Check Offset.....	3-72
Zero and Span Auto Calibration	3-73
NO, NO ₂ , and NO _x Concentration	3-73
Min and Max NO, NO ₂ , and NO _x Concentration Limits.....	3-74
Min Trigger	3-74
External Alarms.....	3-74
Service Menu	3-75
PMT Voltage Adjustment	3-75
Range Mode Select.....	3-76
Converter Set Temperature	3-76
Pressure Calibration	3-77
Calibrate Pressure Zero	3-77
Calibrate Pressure Span.....	3-78
Restore Default Pressure Calibration	3-78
Flow Calibration	3-78
Calibrate Flow Zero	3-79
Calibrate Flow Span.....	3-79
Restore Default Flow Calibration.....	3-80
Input Board Calibration.....	3-80
Manual Input Calibration	3-81
Automatic Input Calibration.....	3-81
Input Frequency Display.....	3-82
Temperature Calibration.....	3-82

Analog Output Calibration	3-83
Analog Output Calibrate Zero	3-84
Analog Output Calibrate Full-Scale	3-84
Analog Input Calibration	3-84
Analog Input Calibrate Zero	3-85
Analog Input Calibrate Full-Scale	3-85
Permeation Oven Settings	3-86
Calibrate Gas Thermistor	3-86
Water Bath	3-87
Resistor	3-87
Calibrate Oven Thermistor	3-87
Permeation Oven Selection	3-88
Factory Calibrate Gas Thermistor	3-88
Low and High Points	3-88
Set Defaults	3-89
Factory Calibrate Oven Thermistor	3-89
Low and High Points	3-89
Set Defaults	3-90
Ozonator Safety	3-90
Extended Ranges	3-91
Dilution Ratio	3-91
Display Pixel Test	3-91
Restore User Defaults	3-92
Password Menu	3-92
Set Password	3-93
Lock Instrument	3-93
Lock/Unlock and Local/Remote Operation	3-93
Change Password	3-94
Remove Password	3-94
Unlock Instrument	3-94

Chapter 4	Calibration	4-1
	Equipment Required	4-1
	Zero Gas Generator	4-2
	Compression	4-2
	Drying	4-2
	Oxidation	4-2
	Scrubbing	4-2
	Gas Phase Titrator	4-3
	Flow Controllers	4-3
	Pressure Regulator	4-3
	Ozone Generator	4-4
	Diverter Valve	4-4
	Reaction Chamber	4-4
	Mixing Chamber	4-4
	Output Manifold	4-4

Reagents..... 4-4
 NO Concentration Standard..... 4-4
 Assaying a Working NO Standard Against a NIST-traceable NO Standard..... 4-5
 Zero Air 4-6
 Dynamic Parameter Specifications for Gas Titrator..... 4-6
 Determining GPT System Flow Conditions 4-6
 Pre-Calibration 4-8
 Calibration..... 4-9
 Connect GPT Apparatus to the Analyzer 4-9
 Adjust Instrument Gain 4-10
 Set NO and NO_x Background to Zero 4-10
 Calibrate the NO Channel to the NO Calibration Gas 4-11
 Calibrate the NO_x Channel to the NO_x Calibration Gas 4-12
 Preparing NO, NO_x, and NO₂ Calibration Curves 4-13
 Alternative Calibration Procedure Using NO₂ Permeation Tube.... 4-16
 Calibration in Dual Range and Auto Range Mode..... 4-16
 Set NO and NO_x Background Readings to Zero 4-16
 Calibrate Low NO 4-17
 Calibrate Low NO_x 4-17
 Calibrate Low NO₂ 4-18
 Calibrate High NO 4-19
 Calibrate High NO_x..... 4-19
 Calibrate High NO₂..... 4-19
 Zero and Span Check..... 4-20

Chapter 5 Preventive Maintenance5-1
 Safety Precautions 5-1
 Replacement Parts..... 5-2
 Cleaning the Outside Case..... 5-2
 Ozonator Air Feed Drying Column Replacement 5-2
 Capillaries Inspection and Replacement 5-2
 Thermoelectric Cooler Fins Inspection and Cleaning..... 5-4
 Fan Filters Inspection and Cleaning..... 5-4
 Pump Rebuilding 5-5

Chapter 6 Troubleshooting.....6-1
 Safety Precautions 6-1
 Troubleshooting Guides..... 6-1
 Board-Level Connection Diagrams 6-6
 Connector Pin Descriptions 6-8
 Service Locations..... 6-21

Chapter 7 Servicing.....7-1
 Safety Precautions 7-2

Firmware Updates 7-4

Accessing the Service Mode 7-4

Replacement Parts List 7-4

Cable List 7-6

External Device Connection Components 7-6

Removing the Measurement Bench and Lowering the Partition Panel 7-8

Pump Replacement 7-9

Fan/Filter Replacement 7-10

PMT Cooler and Reaction Chamber Assembly Replacement 7-11

Photomultiplier Tube Replacement 7-13

PMT High Voltage Power Supply Replacement 7-14

PMT Voltage Adjustment 7-16

Reaction Chamber Cleaning or Removal 7-17

NO₂-to-NO Converter Replacement 7-18

Solenoid Valve Replacement 7-20

Ozonator Assembly Replacement 7-21

Ozonator Transformer Replacement 7-23

Input Board Replacement 7-23

Input Board Calibration 7-25

DC Power Supply Replacement 7-25

Analog Output Testing 7-26

Analog Output Calibration 7-29

Analog Input Calibration 7-30

 Calibrating the Input Channels to Zero Volts 7-30

 Calibrating the Input Channels to Full-Scale 7-30

Pressure Transducer Assembly Replacement 7-31

Pressure Transducer Calibration 7-32

Temperature Control Board Replacement 7-34

Ambient Temperature Calibration 7-35

Fuse Replacement 7-36

Scrubber Replacement 7-36

I/O Expansion Board (Optional) Replacement 7-37

Digital Output Board Replacement 7-39

Motherboard Replacement 7-39

Measurement Interface Board Replacement 7-40

Flow Transducer Replacement 7-41

Flow Transducer Calibration 7-42

Front Panel Board Replacement 7-44

LCD Module Replacement 7-45

Service Locations 7-46

Chapter 8 System Description 8-1

 Hardware 8-1

 NO₂-to-NO Converter 8-2

 Mode Solenoid 8-2

 Reaction Chamber 8-2

Optical Filter.....	8-3
Pressure Transducer	8-3
Sample Flow Sensor	8-3
Ozonator.....	8-3
Ozonator Flow Switch	8-3
Photomultiplier Tube	8-3
Photomultiplier Tube Cooler	8-3
Pump	8-3
Sample Capillary	8-3
Dry Air Capillary	8-4
Software	8-4
Instrument Control.....	8-4
Monitoring Signals.....	8-4
Measurement Calculations	8-5
Output Communication	8-5
Electronics	8-6
Motherboard.....	8-6
External Connectors.....	8-6
Internal Connectors	8-6
Measurement Interface Board	8-7
Measurement Interface Board Connectors.....	8-7
Flow Sensor Assembly	8-7
Pressure Sensor Assembly	8-7
Temperature Control Board.....	8-7
PMT Power Supply Assembly	8-8
Input Board Assembly.....	8-8
Digital Output Board.....	8-8
I/O Expansion Board (Optional)	8-8
Front Panel Connector Board	8-9
I/O Components.....	8-9
Analog Voltage Outputs.....	8-9
Analog Current Outputs (Optional)	8-10
Analog Voltage Inputs (Optional)	8-10
Digital Relay Outputs	8-10
Digital Inputs.....	8-10
Serial Ports	8-11
RS-232 Connection	8-11
RS-485 Connection	8-12
Ethernet Connection.....	8-12
External Accessory Connector	8-12

Chapter 9	Optional Equipment.....	9-1
	Internal Zero/Span and Sample Valves.....	9-1
	Internal Permeation Span Source	9-2
	Permeation Tube Installation	9-3
	Computation of Concentrations	9-4

Oven Installation and Configuration..... 9-4
 Permeation Tube Oven Calibration 9-6
 Setting Perm Oven Temperature..... 9-6
 Setting Temperature with Water Bath..... 9-7
 Setting Temperature with Known Resistance 9-8
 Determining Permeation Rate by Weight Loss..... 9-9
 Determining Release Rate by Transfer Standard..... 9-9
 Ozonator Permeation Dryer 9-10
 Sample Permeation Dryer 9-10
 Lag Volume 9-10
 Principle of Operation 9-10
 Lag Volume Test..... 9-12
 Ammonia Scrubber 9-12
 Teflon Particulate Filter 9-12
 Ozone Particulate Filter 9-13
 NO₂-to-NO Converter 9-13
 I/O Expansion Board Assembly..... 9-13
 25 Pin Terminal Board Assembly..... 9-13
 Terminal Block and Cable Kits 9-13
 Cables 9-14
 Mounting Options..... 9-15

Appendix A Warranty A-1
 Warranty.....A-1

Appendix B C-Link Protocol Commands..... B-1
 Instrument Identification Number..... B-1
 Commands B-2
 Convert Concentration Formats..... B-3
 Commands List..... B-3
 Measurements B-10
 Alarms..... B-14
 Diagnostics B-18
 Datalogging..... B-19
 Calibration..... B-27
 Keys/Display B-33
 Measurement Configuration B-35
 Hardware Configuration B-39
 Communications Configuration B-43
 I/O Configuration..... B-49
 Record Layout Definition B-55
 Format Specifier for ASCII Responses..... B-55
 Format Specifier for Binary Responses B-56
 Format Specifier for EREC Layout..... B-56
 Text B-56

Value String	B-57
Value Source	B-57
Alarm Information	B-57
Translation Table.....	B-57
Selection Table.....	B-57
Button Designator.....	B-58
Examples.....	B-59

Appendix C	MODBUS Protocol.....	C-1
	Serial Communication Parameters	C-1
	TCP Communication Parameters	C-2
	Application Data Unit Definition	C-2
	Slave Address.....	C-2
	MBAP Header	C-2
	Function Code	C-3
	Data.....	C-3
	Error Check	C-3
	Function Codes.....	C-3
	(0x01/0x02) Read Coils / Read Inputs	C-3
	(0x03/0x04) Read Holding Registers / Read Input Registers	C-5
	(0x05) Force (Write) Single Coil.....	C-7
	MODBUS Parameters Supported	C-8
	Reading a Write Coil	C-14

Appendix D	Geysitech (Bayern-Hessen) Protocol.....	D-1
	Serial Communication Parameters	D-1
	TCP Communication Parameters	D-2
	Instrument Address	D-2
	Abbreviations Used	D-2
	Basic Command Structure	D-2
	Block Checksum Characters <BCC>	D-3
	Geysitech Commands	D-3
	Instrument Control Command (ST).....	D-3
	Data Sampling/Data Query Command (DA).....	D-4
	Measurements reported in response to DA command	D-6
	Single Range Mode	D-6
	Dual/Auto Range Mode.....	D-6
	Operating and Error Status	D-6

Figures

Figure 1–1. Model 42i Flow Schematic	1-3
Figure 2–1. Remove the Packing Material	2-2
Figure 2–2. Remove the Shipping Screws	2-2
Figure 2–3. Model 42i Rear Panel	2-3
Figure 2–4. Atmospheric Dump Bypass Plumbing	2-4
Figure 2–5. I/O Terminal Board Views	2-6
Figure 2–6. D/O Terminal Board Views	2-7
Figure 2–7. 25-Pin Terminal Board Views	2-8
Figure 3–1. Front Panel Display	3-2
Figure 3–2. Front Panel Pushbuttons	3-2
Figure 3–3. Flowchart of Menu-Driven Software	3-5
Figure 3–4. Pin-Out of Rear Panel Connector in Single Range Mode	3-9
Figure 3–5. Pin-Out of Rear Panel Connector in Dual Range Mode	3-10
Figure 3–6. Analog Output in Auto Range Mode	3-11
Figure 3–7. Pin-Out of Rear Connector in Auto Range Mode	3-12
Figure 4–1. GPT System	4-3
Figure 5–1. Inspecting and Replacing the Capillaries	5-3
Figure 5–2. Inspecting and Cleaning the Fan Filters	5-5
Figure 5–3. Rebuilding the Pump	5-7
Figure 6–1. Board-Level Connection Diagram - Common Electronics	6-6
Figure 6–2. Board-Level Connection Diagram - Measurement System	6-7
Figure 7–1. Properly Grounded Antistatic Wrist Strap	7-4
Figure 7–2. Component Layout	7-7
Figure 7–3. Removing the Measurement Bench and Lowering the Partition Panel	7-8
Figure 7–4. Replacing the Pump	7-10
Figure 7–5. Replacing the Fan	7-11
Figure 7–6. PMT Cooler and Reaction Chamber	7-12
Figure 7–7. Replacing the PMT	7-14
Figure 7–8. Replacing the PMT HVPS	7-15
Figure 7–9. Cleaning or Removing the Reaction Chamber	7-18
Figure 7–10. NO ₂ -to-NO Molybdenum Converter Assembly	7-19
Figure 7–11. Replacing the Solenoid Valve	7-21
Figure 7–12. Replacing the Ozonator Assembly	7-22
Figure 7–13. Replacing the Input Board	7-24
Figure 7–14. Replacing the DC Power Supply	7-26

Figures

Figure 7–15. Rear Panel Analog Input and Output Pins	7-27
Figure 7–16. Replacing the Pressure Transducer	7-32
Figure 7–17. Replacing the Scrubber	7-37
Figure 7–18. Replacing the I/O Expansion Board (Optional)	7-38
Figure 7–19. Rear Panel Board Connectors	7-38
Figure 7–20. Replacing the Measurement Interface Board	7-41
Figure 7–21. Replacing the Flow Transducer	7-42
Figure 7–22. Replacing the Front Panel Board and the LCD Module.....	7-45
Figure 8–1. Hardware Components	8-2
Figure 9–1. Flow Diagram, Zero/Span Option	9-2
Figure 9–2. Flow Diagram, Internal Permeation with Zero/Span Valve	9-3
Figure 9–3. Flow Diagram, Lag Volume	9-12
Figure 9–1. Bench Mounting.....	9-16
Figure 9–2. EIA Rack Mounting	9-17
Figure 9–3. Retrofit Rack Mounting.....	9-18
Figure 9–4. Rack Mount Option Assembly	9-19
Figure B–1. Flags	B-14

Tables

Table 1–1. Model 42 <i>i</i> Specifications	1-3
Table 1–2. Model 42 <i>i</i> Optional Permeation Oven Specifications.....	1-4
Table 2–1. I/O Terminal Board Pin Descriptions	2-6
Table 2–2. D/O Terminal Board Pin Descriptions.....	2-7
Table 2–3. 25-Pin Terminal Board Pin Descriptions.....	2-8
Table 3–1. Front Panel Pushbuttons	3-3
Table 3–2. Default Analog Outputs in Single Range Mode.....	3-9
Table 3–3. Default Analog Outputs in Dual Range Mode	3-10
Table 3–4. Default Analog Outputs in Auto Range Mode	3-12
Table 3–5. Standard Ranges.....	3-14
Table 3–6. Extended Ranges	3-15
Table 3–7. Analog Output Zero to Full-Scale Table	3-50
Table 3–8. Signal Type Group Choices.....	3-52
Table 4–1. Scrubbing Materials	4-2
Table 6–1. Troubleshooting - General Guide	6-2
Table 6–2. Troubleshooting - Alarm Messages	6-4
Table 6–3. Motherboard Connector Pin Descriptions.....	6-8
Table 6–4. Measurement Interface Board Connector Pin Descriptions	6-13
Table 6–5. Front Panel Board Connector Pin Diagram.....	6-15
Table 6–6. I/O Expansion Board (Optional) Connector Pin Descriptions	6-17
Table 6–7. Digital Output Board Connector Pin Descriptions.....	6-18
Table 6–8. Input Board Connector Pin Descriptions	6-20
Table 6–9. Temperature Control Board Connector Pin Descriptions.....	6-20
Table 7–1. Model 42 <i>i</i> Replacement Parts.....	7-4
Table 7–2. Model 42 <i>i</i> Cables.....	7-6
Table 7–3. External Device Connection Components	7-6
Table 7–4. Analog Output Channels and Rear Panel Pin Connections.....	7-28
Table 7–5. Analog Input Channels and Rear Panel Pin Connections.....	7-28
Table 8–1. RS-232 DB9 Connector Pin Configurations	8-12
Table 8–2. RS-485 DB9 Connector Pin Configuration.....	8-12
Table 9–1. Cable Options.....	9-14
Table 9–2. Color Codes for 25-Pin and 37-Pin Cables	9-14
Table 9–3. Mounting Options	9-15
Table B–1. Error Response Messages	B-3
Table B–1. C-Link Protocol Commands	B-3

Table B–2. Averaging Times.....	B-11
Table B–3. Alarm Trigger Values.....	B-18
Table B–4. Record Output Formats.....	B-23
Table B–5. Stream Time Values	B-27
Table B–6. Standard Ranges	B-35
Table B–7. Extended Ranges	B-36
Table B–8. Contrast Levels	B-39
Table B–9. Reply Termination Formats	B-46
Table B–10. Allow Mode Command Values	B-48
Table B–11. Power Up Mode Values.....	B-48
Table B–12. Set Layout Ack Values.....	B-49
Table B–13. Analog Current Output Range Values	B-50
Table B–14. Analog Voltage Output Range Values	B-51
Table B–15. Default Output Assignment.....	B-52
Table C–1. Read Coils for 42 <i>i</i>	C-8
Table C–2. Read Registers for 42 <i>i</i>	C-11
Table C–3. Write Coils for 42 <i>i</i>	C-13
Table D–1. Operating Status for Model 42 <i>i</i>	D-7
Table D–2. Error Status for Model 42 <i>i</i>	D-7

Chapter 1

Introduction

The Model 42*i* Chemiluminescence NO-NO₂-NO_x Analyzer combines proven detection technology, easy to use menu-driven software, and advanced diagnostics to offer unsurpassed flexibility and reliability. The Model 42*i* has the following features:

- 320 x 240 graphics display
- Menu-driven software
- Field programmable ranges
- User-selectable single/dual/auto range modes
- Multiple user-defined analog outputs
- Analog input options
- High sensitivity
- Fast response time
- Linearity through all ranges
- Internal sample pump (except with internal permeation span source option)
- Independent NO-NO₂-NO_x ranges
- Replaceable NO₂ converter cartridge
- User-selectable digital input/output capabilities
- Standard communications features include RS232/485 and Ethernet
- C-Link, MODBUS, Geysitech (Bayern-Hessen), streaming data, and NTP (Network Time Protocol) protocols. Simultaneous connections from different locations over Ethernet.

For details of the analyzer's principle of operation and product specifications, see the following topics:

- [“Principle of Operation”](#) on page 1-2
- [“Specifications”](#) on page 1-3

Thermo Fisher Scientific is pleased to supply this NO-NO₂-NO_x analyzer. We are committed to the manufacture of instruments exhibiting high standards of quality, performance, and workmanship. Service personnel are available for assistance with any questions or problems that may arise in the use of this analyzer. For more information on servicing, see Chapter 7, “[Servicing](#)”.

Principle of Operation

The Model 42*i* operates on the principle that nitric oxide (NO) and ozone (O₃) react to produce a characteristic luminescence with an intensity linearly proportional to the NO concentration. Infrared light emission results when electronically excited NO₂ molecules decay to lower energy states. Specifically:



Nitrogen dioxide (NO₂) must first be transformed into NO before it can be measured using the chemiluminescent reaction. NO₂ is converted to NO by a molybdenum NO₂-to-NO converter heated to about 325 °C (the optional stainless steel converter is heated to 625 °C).

The ambient air sample is drawn into the Model 42*i* through the *sample* bulkhead, as shown in [Figure 1–1](#). The sample flows through a capillary, and then to the mode solenoid valve. The solenoid valve routes the sample either straight to the reaction chamber (NO mode) or through the NO₂-to-NO converter and then to the reaction chamber (NO_x mode). A flow sensor to the reaction chamber measures the sample flow.

Dry air enters the Model 42*i* through the *dry air* bulkhead, passes through a flow switch, and then through a silent discharge ozonator. The ozonator generates the ozone needed for the chemiluminescent reaction. At the reaction chamber, the ozone reacts with the NO in the sample to produce excited NO₂ molecules. A photomultiplier tube (PMT) housed in a thermoelectric cooler detects the luminescence generated during this reaction. From the reaction chamber, the exhaust travels through the ozone (O₃) converter to the pump, and is released through the vent.

The NO and NO_x concentrations calculated in the NO and NO_x modes are stored in memory. The difference between the concentrations is used to calculate the NO₂ concentration. The Model 42*i* outputs NO, NO₂, and NO_x concentrations to the front panel display, the analog outputs, and also makes the data available over the serial or Ethernet connection.

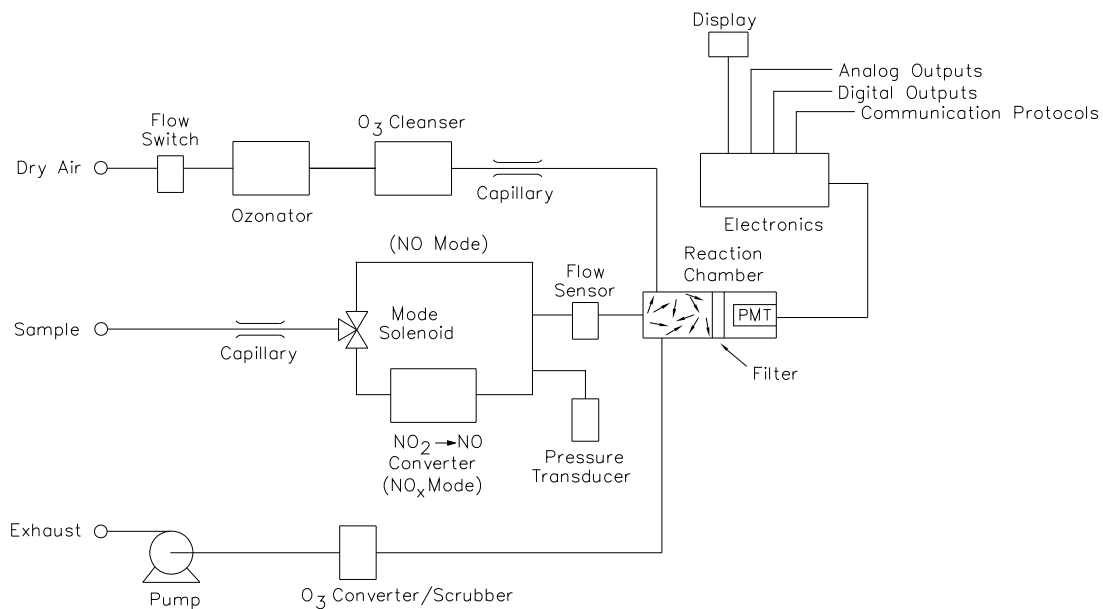

Figure 1–1. Model 42*i* Flow Schematic

Specifications

Table 1–1 lists the specifications for the Model 42*i*.

Table 1–1. Model 42*i* Specifications

Preset ranges	0-0.05, 0.1, 0.2, 0.5, 1, 2, 5, 10, 20 ppm 0-0.1, 0.2, 0.5, 1, 2, 5, 10, 20, 30 mg/m ³
Extended ranges	0-0.2, 0.5, 1, 2, 5, 10, 20, 50, 100 ppm 0-0.5, 1, 2, 5, 10, 20, 50, 100, 150 mg/m ³
Custom ranges	0-0.05 to 20 ppm (0-0.2 to 100 ppm in extended ranges) 0-0.1 to 30 mg/m ³ (0-0.5 to 150 mg/m ³ in extended ranges)
Zero noise	0.20 ppb RMS (60 second averaging time)
Lower detectable limit	0.40 ppb (60 second averaging time)
Zero drift (24 hour)	< 0.40 ppb
Span drift	±1% full-scale
Response time (in automatic mode)	40 seconds (10 second averaging time) 80 seconds (60 second averaging time) 300 seconds (300 second averaging time)
Linearity	±1% full-scale
Sample flow rate	0.6–0.8 LPM
Operating temperature	15–35 °C (may be safely operated over the 0–45 °C)*

Power requirements	100 VAC @ 50/60 Hz 115 VAC @ 50/60 Hz 220–240 VAC @ 50/60 Hz 300 watts
Physical dimensions	16.75" (W) X 8.62" (H) X 23" (D)
Weight	Approximately 55 lbs.
Analog outputs	6 voltage outputs; 0–100 mV, 1, 5, 10 V (user selectable), 5% of full-scale over/under range (user selectable), 12 bit resolution, measurement output user selectable per channel
Digital outputs	1 power fail relay Form C, 10 digital relays Form A, user selectable alarm output, relay logic, 100 mA @ 200 VDC
Digital inputs	16 digital inputs, user select programmable, TTL level, pulled high
Serial Ports	1 RS-232 or RS-485 with two connectors, baud rate 1200–115200, data bits, parity, and stop bits, protocols: C-Link, MODBUS, Geysitech (Bayern-Hessen), and streaming data (all user selectable)
Ethernet connection	RJ45 connector for 10Mbps Ethernet connection, static or dynamic TCP/IP addressing

*In non-condensing environments. Performance specifications based on operation in 15–35 °C range.

Table 1–2. Model 42*i* Optional Permeation Oven Specifications

Temperature control	Single Point 45 °C
Temperature stability	±0.1 °C
Warm-up time	1 hour (permeation device can take 24 to 48 hours to stabilize)
Carrier gas flow	≈ 70 scc/min
Chamber size	Accepts permeation tubes up to 9 cm in total length; 1 cm in diameter
Temperature range	15–30 °C
Power requirements	120 VAC @ 50/60 Hz, 50 watts (in addition to the standard Model 42 <i>i</i>)
Weight	Approximately 5 lbs. (in addition to the standard Model 42 <i>i</i>)

Chapter 2

Installation

Installation of the Model 42*i* includes lifting the instrument, unpacking and inspection, connecting sample, zero, span, and exhaust lines, and attaching the analog and/or digital outputs to a recording device. The installation should always be followed by instrument calibration as described in the “[Calibration](#)” chapter of this manual.

Installing the Model 42*i* includes the following recommendations and procedures:

- “[Lifting](#)” on page 2-1
- “[Unpacking and Inspection](#)” on page 2-1
- “[Setup Procedure](#)” on page 2-3
- “[Connecting External Devices](#)” on page 2-5
- “[Startup](#)” on page 2-9

Lifting

When lifting the instrument, use procedure appropriate to lifting a heavy object, such as, bending at the knees while keeping your back straight and upright. Grasp the instrument at the bottom in the front and at the rear of the unit. Although one person can lift the unit, it is desirable to have two persons lifting, one by grasping the bottom in the front and the other by grasping the bottom in the rear.



Equipment Damage Do not attempt to lift the instrument by the cover or other external fittings. ▲

Unpacking and Inspection

The Model 42*i* is shipped complete in one container. If there is obvious damage to the shipping container when you receive the instrument, notify the carrier immediately and hold for inspection. The carrier is responsible for any damage incurred during shipment.

Use the following procedure to unpack and inspect the instrument.

1. Remove the instrument from its shipping container and set it on a table or bench that allows easy access to both the front and rear.

Installation

Unpacking and Inspection

2. Remove the cover to expose the internal components.
3. Remove the packing material (Figure 2–1).

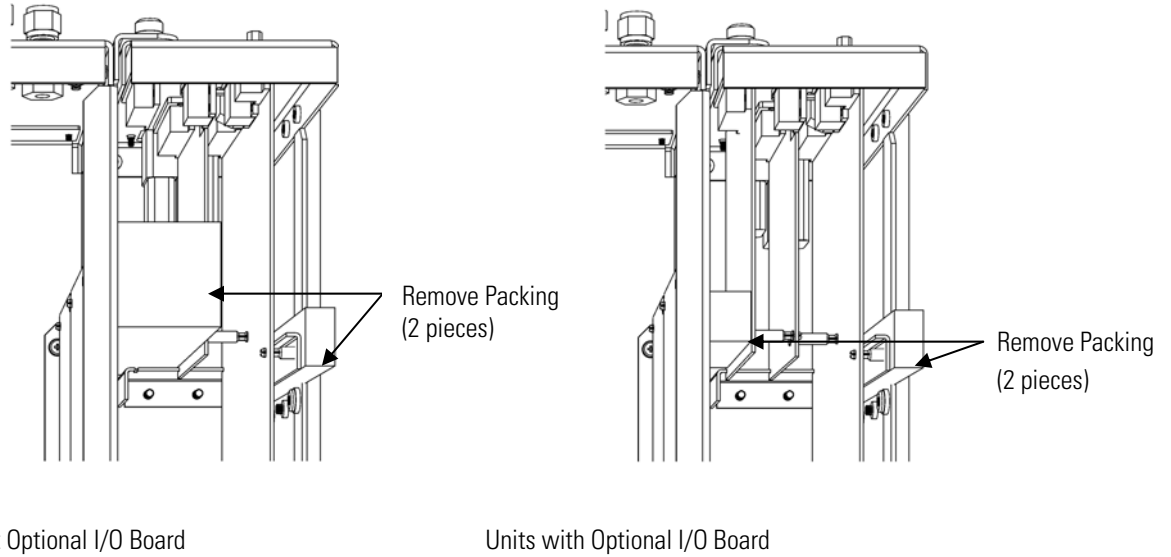

Figure 2–1. Remove the Packing Material

4. Remove the three shipping screws (Figure 2–2).

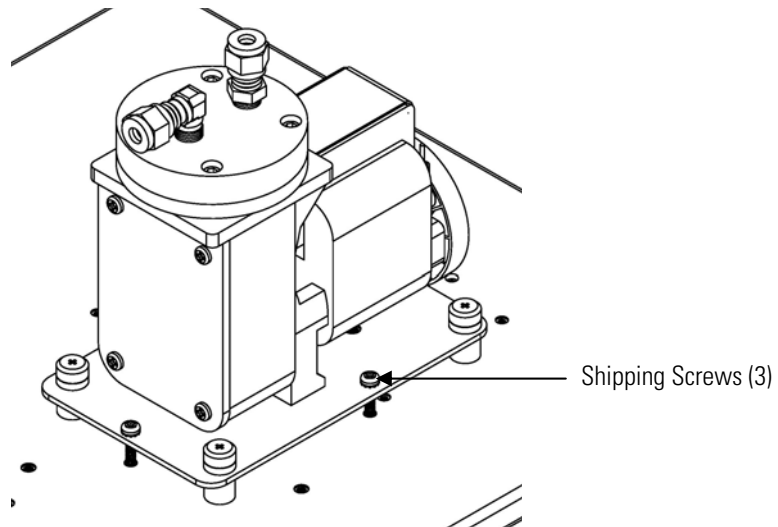

Figure 2–2. Remove the Shipping Screws

5. Check for possible damage during shipment.

6. Check that all connectors and circuit boards are firmly attached.
7. Re-install the cover.
8. Remove any protective plastic material from the case exterior.

Setup Procedure

Use the following procedure to setup the instrument:

1. Connect the sample line to the SAMPLE bulkhead on the rear panel (Figure 2–3). Ensure that the sample line is not contaminated by dirty, wet, or incompatible materials. All tubing should be constructed of FEP Teflon®, 316 stainless steel, borosilicate glass, or similar tubing with an OD of 1/4-inch and a minimum ID of 1/8-inch. The length of the tubing should be less than 10 feet.

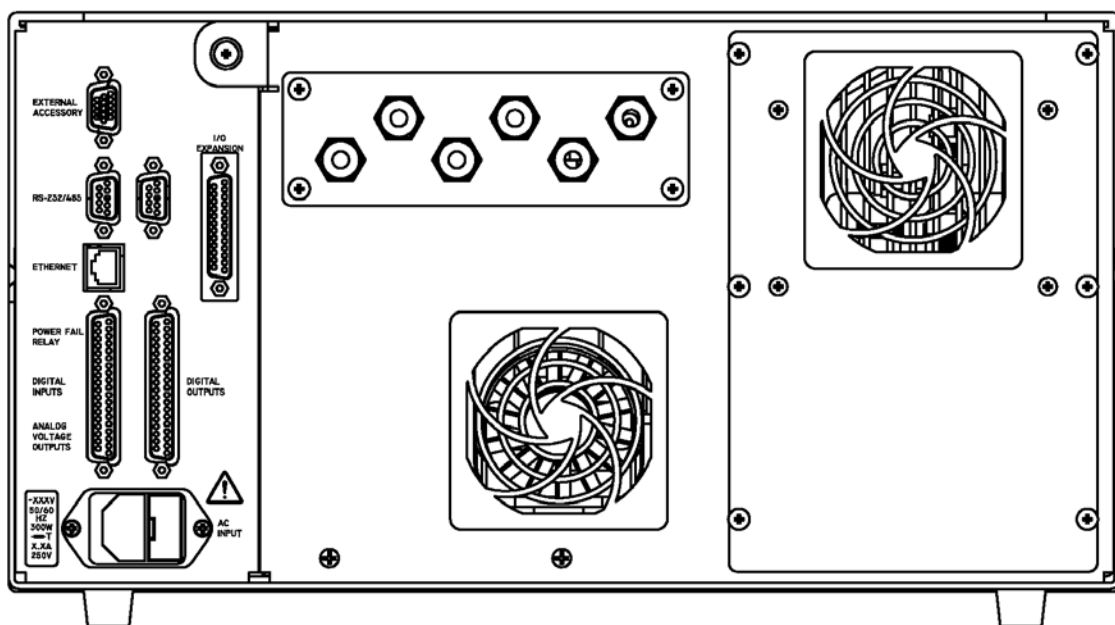

Figure 2–3. Model 42i Rear Panel

Note Gas must be delivered to the instrument free of particulates. It may be necessary to use the Teflon particulate filter as described in “[Teflon Particulate Filter](#)” on page 9-12. ▲

Note Gas must be delivered to the instrument at atmospheric pressure. It may be necessary to use an atmospheric bypass plumbing arrangement as shown in [Figure 2-4](#) if gas pressure is greater than atmospheric pressure. ▲

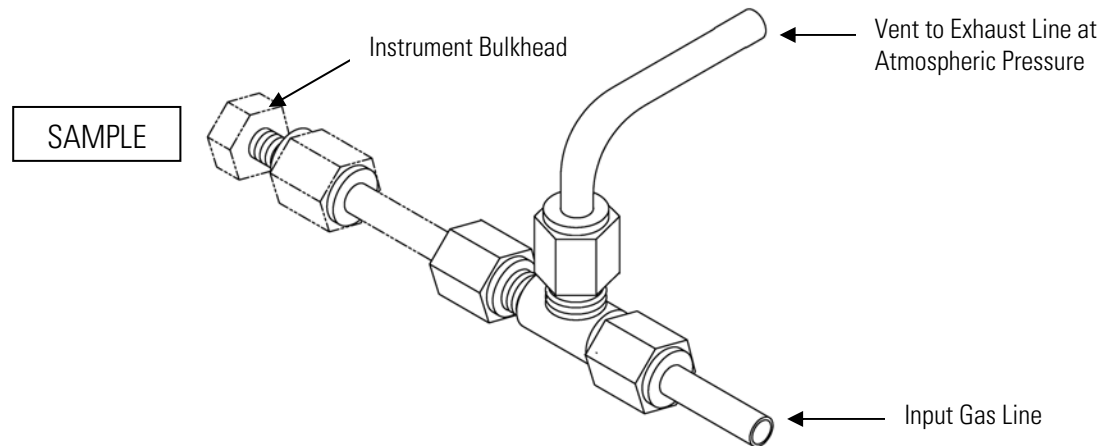

Figure 2-4. Atmospheric Dump Bypass Plumbing

2. Connect the air dryer to the DRY AIR bulkhead.
3. Connect the EXHAUST bulkhead to a suitable vent or ozone scrubber. The exhaust line should be 1/4-inch OD with a minimum ID of 1/8-inch. The length of the exhaust line should be less than 10 feet. Verify that there is no restriction in this line.
4. Connect a suitable recording device to the rear panel connector. For detailed information about connecting to the instrument, refer to:
 - “[Connecting External Devices](#)” on page 2-5
 - “[Instrument Controls Menu > I/O Configuration](#)” on page 3-43
 - “[External Device Connection Components](#)” on page 7-6
 - “[Terminal Block and Cable Kits](#)” on page 9-13

For detailed information about troubleshooting a connection, refer to “[Analog Output Testing](#)” on page 7-26.

5. Plug the instrument into an outlet of the appropriate voltage and frequency.



Connecting External Devices

WARNING The Model 42i is supplied with a three-wire grounding cord. Under no circumstances should this grounding system be defeated. ▲

Several components are available for connecting external devices to *iSeries* instruments.

These connection options include:

- Individual terminal board PCB assemblies
- Terminal block and cable kits (optional)
- Individual cables (optional)

For detailed information on the optional connection components, refer to the “[Optional Equipment](#)” chapter. For associated part numbers, refer to “[External Device Connection Components](#)” on page 7-6.

Terminal Board PCB Assemblies

The terminal board PCB assemblies are circuit boards with a D-Sub connector on one side and a series of screw terminals on the other side. This assembly provide a convenient mechanism for connecting wires from a data system to the analyzer’s I/O connectors.

The following terminal board PCB assemblies are available for *iSeries* instruments:

- I/O terminal board PCB assembly, 37 pin (standard)
- D/O terminal board PCB assembly, 37 pin (standard)
- 25-pin terminal board PCB assembly, (included with optional I/O expansion board)

I/O Terminal Board

[Figure 2-5](#) shows the recommended method for attaching the cable to the terminal board using the included tie-down and spacer. [Table 2-1](#) identifies the connector pins and associated signals.

Note Not all of the I/O available in the instrument is brought out on the supplied terminal board. If more I/O is desired, an alternative means of connection is required. See optional “[Terminal Block and Cable Kits](#)”. ▲

Installation

Connecting External Devices

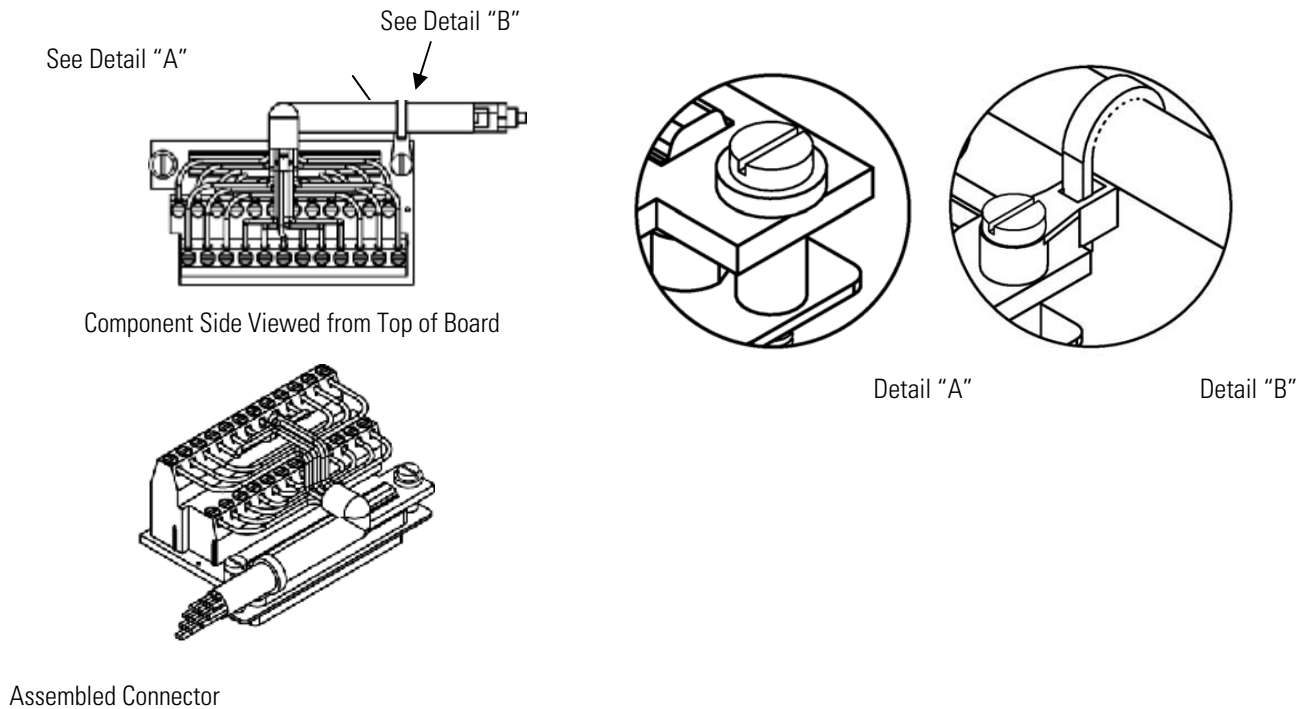

Figure 2–5. I/O Terminal Board Views

Table 2–1. I/O Terminal Board Pin Descriptions

Screw	Signal Description	Screw	Signal Description
1	Analog1	13	Power_Fail_NC
2	Analog ground	14	Power_Fail_COM
3	Analog2	15	Power_Fail_NO
4	Analog ground	16	TTL_Input1
5	Analog3	17	TTL_Input2
6	Analog ground	18	TTL_Input3
7	Analog4	19	TTL_Input4
8	Analog ground	20	Digital ground
9	Analog5	21	TTL_Input5
10	Analog ground	22	TTL_Input6
11	Analog6	23	TTL_Input7
12	Analog ground	24	Digital ground

D/O Terminal Board Figure 2–6 shows the recommended method for attaching the cable to the terminal board using the included tie-down and spacer. Table 2–2 identifies the connector pins and associated signals.

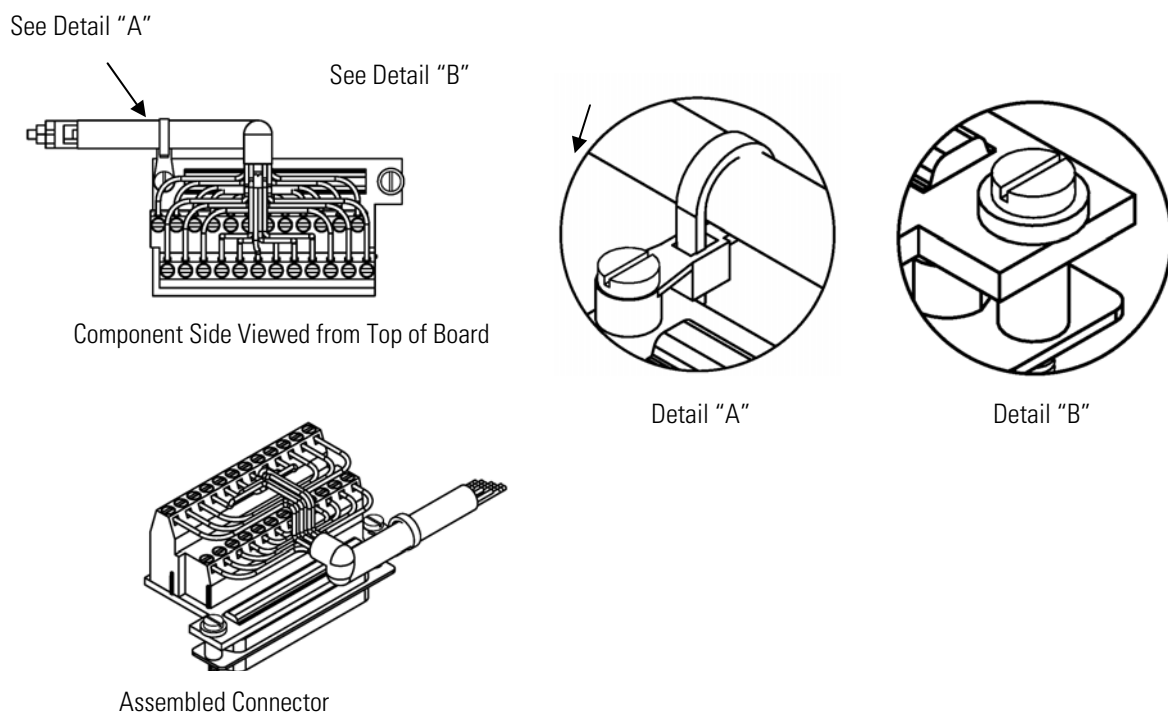

Figure 2–6. D/O Terminal Board Views

Table 2–2. D/O Terminal Board Pin Descriptions

Screw	Signal Description	Screw	Signal Description
1	Relay1_ContactA	13	Relay7_ContactA
2	Relay1_ContactB	14	Relay7_ContactB
3	Relay2_ContactA	15	Relay8_ContactA
4	Relay2_ContactB	16	Relay8_ContactB
5	Relay3_ContactA	17	Relay9_ContactA
6	Relay3_ContactB	18	Relay9_ContactB
7	Relay4_ContactA	19	Relay10_ContactA
8	Relay4_ContactB	20	Relay10_ContactB
9	Relay5_ContactA	21	Solenoid_Drive_Output 1
10	Relay5_ContactB	22	+24V
11	Relay6_ContactA	23	Solenoid_Drive_Output 2
12	Relay6_ContactB	24	+24V

Installation

Connecting External Devices

25-Pin Terminal Board

The 25-pin terminal board is included with the optional I/O Expansion Board.

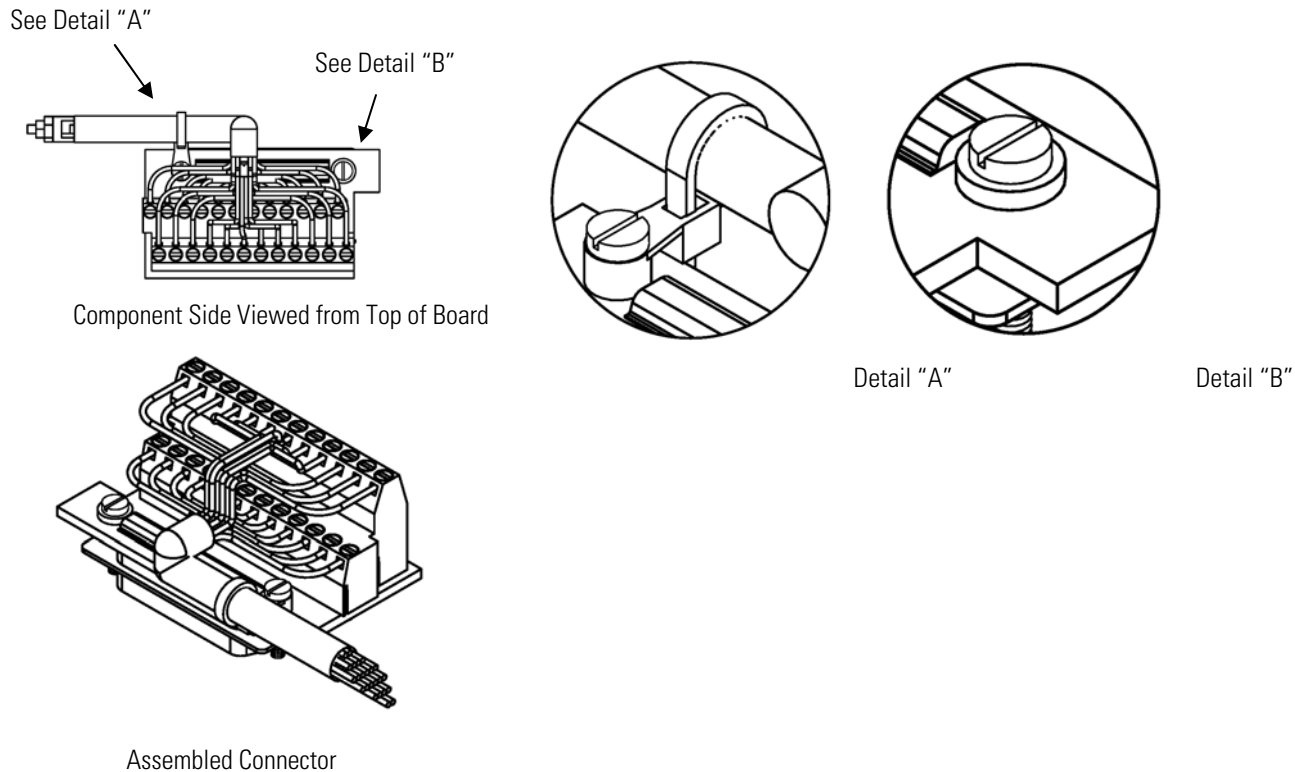

Figure 2-7. 25-Pin Terminal Board Views

Table 2-3. 25-Pin Terminal Board Pin Descriptions

Screw	Signal Description	Screw	Signal Description
1	IOut1	13	Analog_In1
2	Isolated ground	14	Analog_In2
3	IOut2	15	Analog_In3
4	Isolated ground	16	GNDD
5	IOut3	17	Analog_In4
6	Isolated ground	18	Analog_In5
7	IOut4	19	Analog_In6
8	Isolated ground	20	GNDD
9	IOut5	21	Analog_In7
10	Isolated ground	22	Analog_In8
11	IOut6	23	GNDD
12	Isolated ground	24	GNDD

Startup Use the following procedure when starting the instrument.

1. Turn the power ON.
2. Allow 90 minutes for the instrument to stabilize.

Note it is best to turn the ozonator on and let the instrument run overnight before calibration in order to obtain the most accurate information. ▲

3. Set instrument parameters such as operating ranges and averaging times to appropriate settings. For more information about instrument parameters, see the “[Operation](#)” chapter.
4. Before beginning the actual monitoring, perform a multipoint calibration as described in the “[Calibration](#)” chapter.



Chapter 3

Operation

This chapter describes the front panel display, front panel pushbuttons, and menu-driven software. For details, see the following topics:

- “Display” on page 3-1
- “Pushbuttons” on page 3-2
- “Firmware Overview” on page 3-4
- “Range Menu” on page 3-8
- “Averaging Time” on page 3-16
- “Calibration Factors Menu” on page 3-17
- “Calibration Menu” on page 3-20
- “Instrument Controls Menu” on page 3-21
- “Diagnostics Menu” on page 3-58
- “Alarms Menu” on page 3-66
- “Service Menu” on page 3-75
- “Password Menu” on page 3-92

Display

The 320 x 240 graphics liquid-crystal display (LCD) shows the sample concentrations, instrument parameters, instrument controls, help, and error messages. Some menus contain more items than can be displayed at one time. For these menus, use  and  to move the cursor up and down to each item.

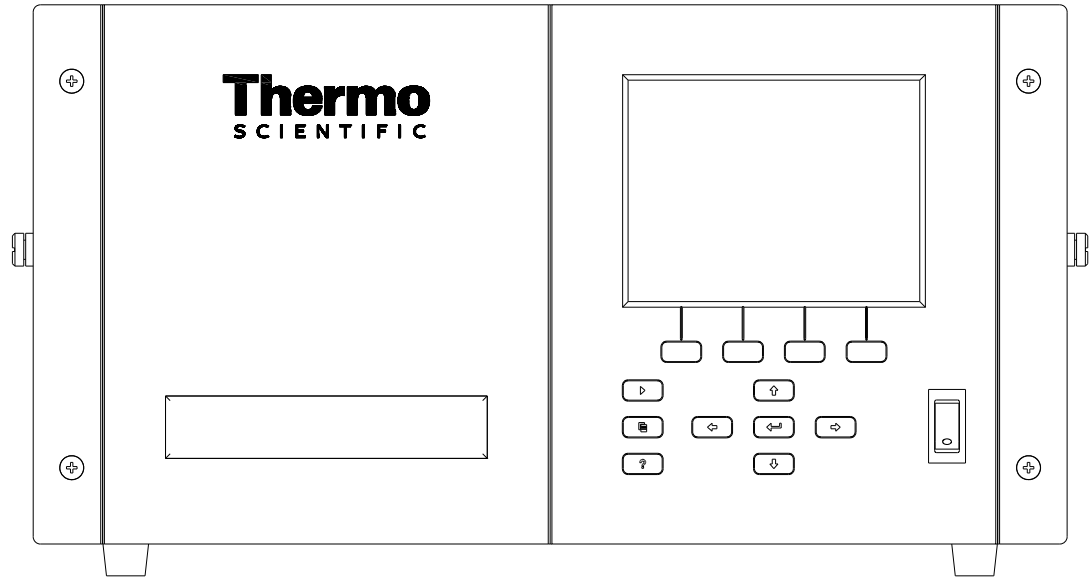

Figure 3–1. Front Panel Display



CAUTION If the LCD panel breaks, do not let the liquid crystal contact your skin or clothes. If the liquid crystal contacts your skin or clothes, wash it off immediately using soap and water. ▲

Pushbuttons

The Pushbuttons allow the user to traverse the various screens/menus.

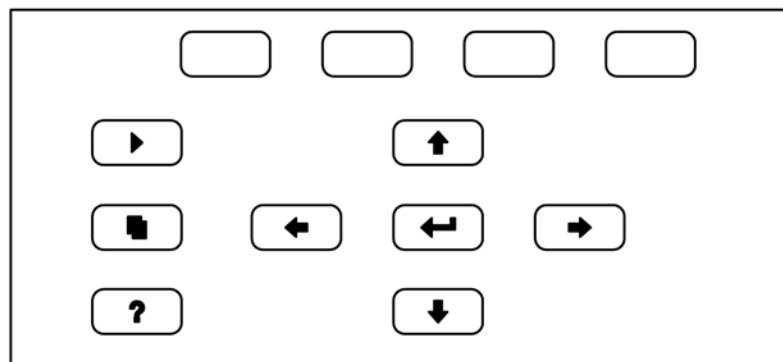























Figure 3–2. Front Panel Pushbuttons

Table 3–1 lists the front panel pushbuttons and their functions.

Table 3–1. Front Panel Pushbuttons

Key Name	Function
 = Soft Keys	The  (soft keys) are used to provide shortcuts that allow the user to jump to user-selectable menu screens. For more information on processing soft keys, see “Soft Keys” below.
 = Run	The  is used to display the Run screen. The Run screen normally displays the NO, NO ₂ , and NO _x concentrations.
 = Menu	The  is used to display the Main Menu when in the Run screen, or back up one level in the menu system. For more information about the Main Menu, see “Main Menu” later in this chapter.
 = Help	The  is context-sensitive, that is, it provides additional information about the screen that is being displayed. Press  for a brief explanation about the current screen or menu. Help messages are displayed using lower case letters to easily distinguish them from the operating screens. To exit a help screen, press  or  to return to the previous screen, or  to return to the Run screen.
  = Up, Down   = Left, Right	The four arrow pushbuttons ( ,  ,  , and ) move the cursor up, down, left, and right or change values and states in specific screens.
 = Enter	The  is used to select a menu item, accept/set/save a change, and/or toggle on/off functions.

Soft Keys

The soft keys are multi-functional keys that use part of the display to identify their function. The function of the soft keys is to provide a shortcut to the most often used menus and screens. They are located directly underneath the display, and user-defined labels in the lower part of the display indicate the function of each key at that time.

To change a soft key, place the menu cursor “>” on the item of the selected menu or screen you wish to set. Press  followed by the selected soft key within 1 second of pressing the right-arrow key. The “edit soft key prompt” will be displayed for configuration of the new label.

Note Not all menu items may be assigned to soft keys. If a particular menu or screen item cannot be assigned, the key assignment screen will not come up upon entering right-arrow-soft key combinations. All items under the Service menu (including the menu itself) cannot be assigned soft keys. ▲



Alphanumeric Entry Screen

The alphanumeric entry screen is used to enter strings consisting of letters, numbers, and other characters. The cursor may be positioned within the entry line using the and keys. If a character is entered over an existing character, that character will be overwritten. Use the and keys to switch between the entry line and the keyboard as well as to move within the keyboard. To select a character to add to the string, use the cursor keys to position the cursor over the desired character, and then press the key to add that character to the entry line.

On the right side of the keyboard are special functions. BKSP is used to move the cursor in the entry line one place to the left, deleting the character that was to the left of the cursor and moving any character at or to the right of the cursor one place to the left. PAGE is used to change the keyboard character page. For the English language, this switches between upper and lower-case alphabetic characters. SAVE stores the string from the entry line into the parameter. Alternately, if the active cursor is moved to the entry line, may be pressed to store the string from the entry line into the parameter.

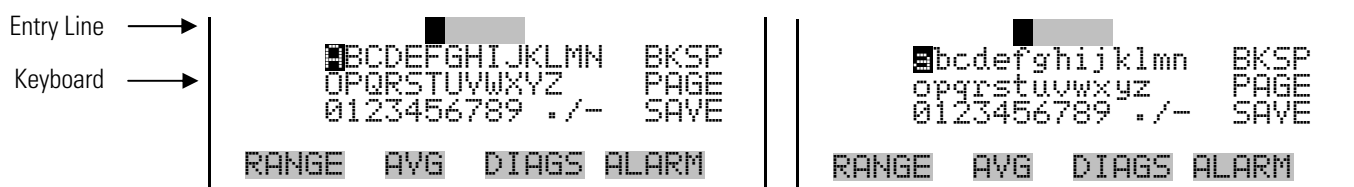

Firmware Overview

The Model 42i utilizes the menu-driven firmware as illustrated by the flowchart in [Figure 3-3](#). The Power-Up screen, shown at the top of the flowchart, is displayed each time the instrument is turned on. This screen is displayed while the instrument is warming up and performing self-checks. After the warm-up period, the Run screen is automatically displayed. The Run screen is the normal operating screen. It displays the NO, NO₂, and NO_x concentrations, depending on operating mode. From the Run screen, the Main Menu can be displayed by pressing . The Main Menu contains a list of submenus. Each submenu contains related instrument settings. This chapter describes each submenu and screen in detail. Refer to the appropriate sections for more information.

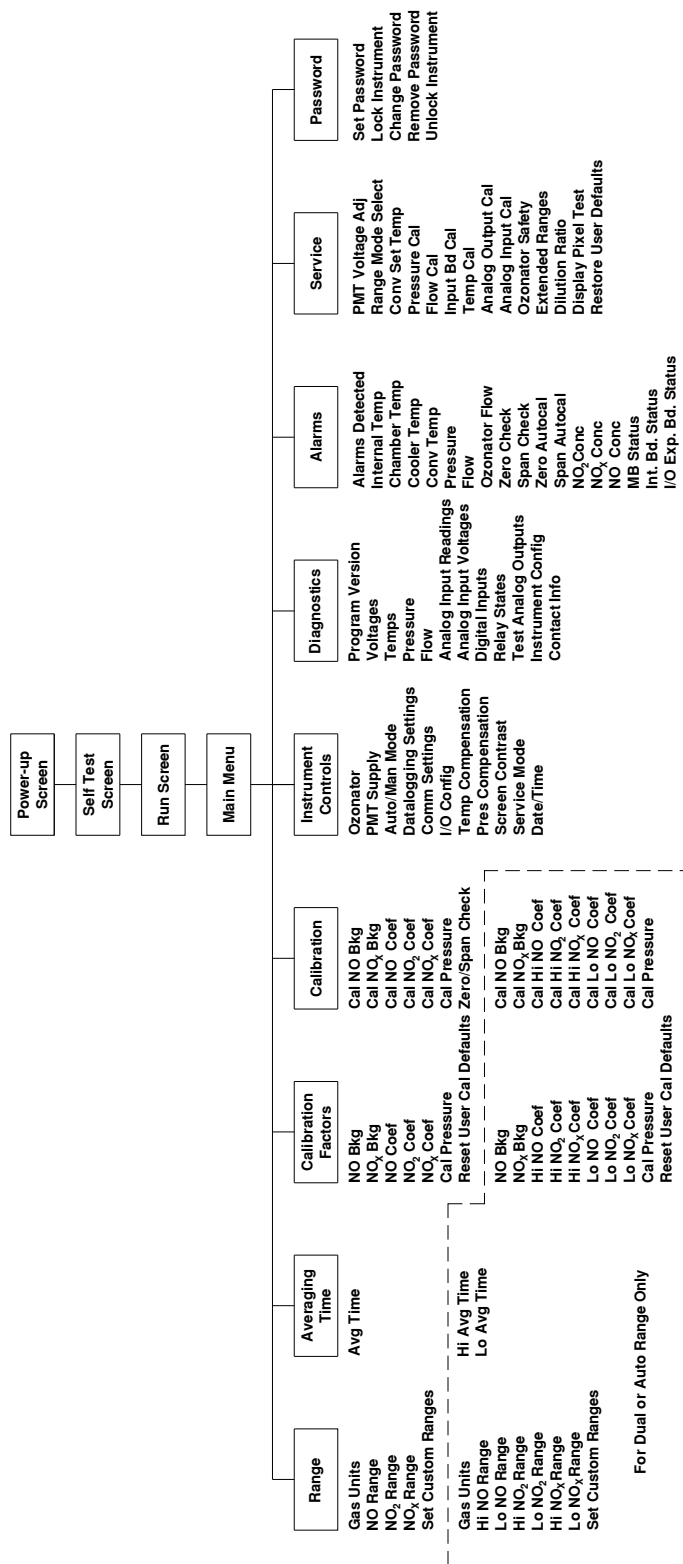

Figure 3–3. Flowchart of Menu-Driven Software

Power-Up Screen

The Power-Up screen is displayed when power is applied to the Model 42i. This screen is displayed while the internal components are warming up and diagnostic checks are being performed.



Run Screen

The Run screen displays the NO, NO₂, and NO_x concentrations. The status bar displays the time (24-hour format), the password (lock) icon, service (wrench) icon, alarm (bell) icon, and optional zero/span sample solenoid valve status, if installed.

Status Bar Icons



The password (lock) icon indicates that no parameter changes can be made from the front panel.



The alarm (bell) icon indicates that an alarm is active.

The service (wrench) icon indicates that the instrument is in the service mode.



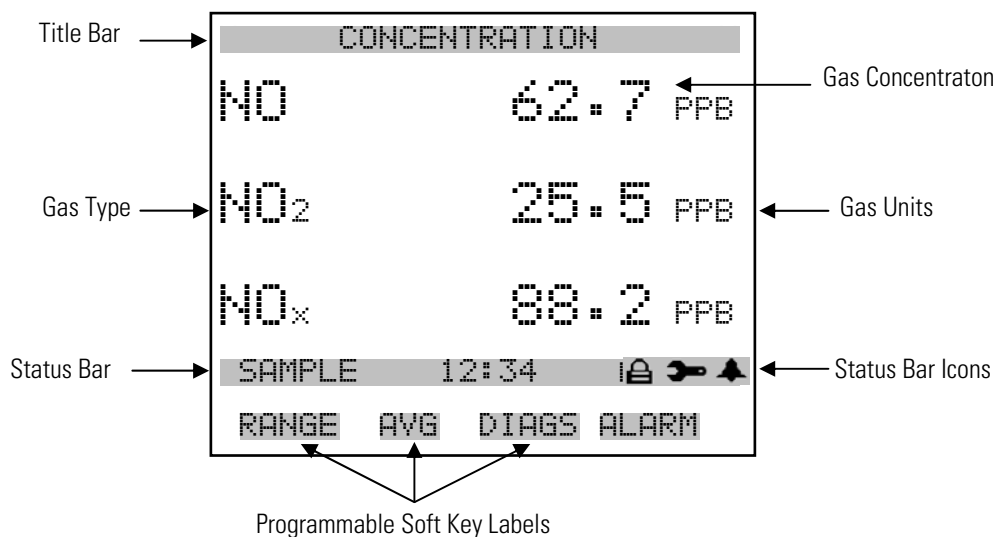

The word "SAMPLE" on the left of the status bar indicates the analyzer has the span/zero valve option and is in "SAMPLE" mode. Other modes appear in the same area of the display as "ZERO" or "SPAN". For more information about the optional solenoid valves, see Chapter 9, "[Optional Equipment](#)".

When operating in dual or auto range mode two sets of coefficients are used to calculate the NO-NO₂-NO_x “High” and “Low” concentrations. Also, two averaging times are used—one for each range. The title bar indicates which range concentrations are displayed. The words “LOW RANGE CONCENTRATION” on the top of the display indicates that the low concentration is displayed. In dual range mode, pressing the  and  arrows will toggle between high and low concentrations. The example below shows the Run screen in single range mode.



Main Menu

The Main Menu contains a number of submenus. Instrument parameters and settings can be read and modified within the submenus according to their function. The concentration appears above the Main Menu and submenus in every screen. The Service menu is visible only when the instrument is in service mode. For more information on the service mode, see “[Service Mode](#)” later in this chapter.

- Use  and  to move the cursor up and down.
- Press  to make a selection.
- Press  to return to the Main Menu or  to return to the Run screen.



SERVICE
PASSWORD

Range Menu

The Range menu allows the operator to select the gas units, NO-NO₂-NO_x ranges, and to set the custom ranges. The screens below show the range menu in single range mode and dual/auto range modes. The only difference between the screens are the words “HI” and “LO” to indicate which range is displayed. For more information about the single, dual and auto range modes, see “[Single Range Mode](#)”, “[Dual Range Mode](#)”, and “[Auto Range Mode](#)” below.

- In the Main Menu, choose **Range**

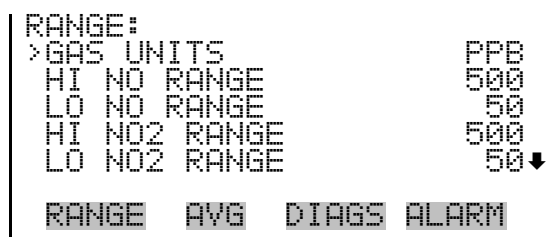

```

HI NOx RANGE        500
LO NOx RANGE        50
SET CUSTOM RANGES
  
```

Single Range Mode

In the single range mode, the NO, NO₂, and NO_x channels each have one range, one averaging time, and one span coefficient.

By default, the three analog outputs are arranged on the rear panel connector as shown in [Figure 3-4](#). See [Table 3-2](#) for channels and pin

connections. Single range mode may be selected from the “Range Mode Select” on page 3-76.

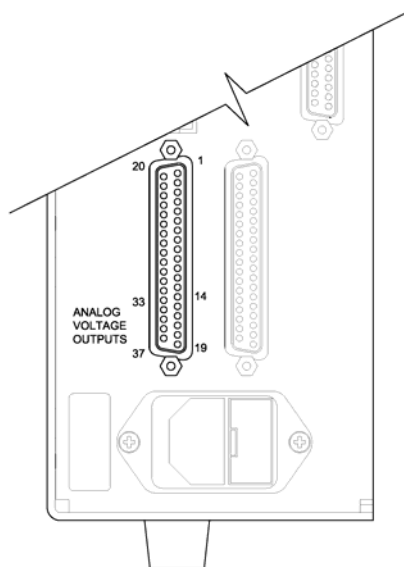

Figure 3-4. Pin-Out of Rear Panel Connector in Single Range Mode

Table 3-2. Default Analog Outputs in Single Range Mode

Channel	Connector Pin	I/O Terminal Pin	Description
1	14	1	NO Analog Output
2	33	3	NO ₂ Analog Output
3	15	5	NO _x Analog Output
4	34	7	None
5	17	9	None
6	36	11	None
Ground	16, 18, 19, 35, 37	2, 4, 6, 8, 10, 12	Signal Ground

Note All channels are user definable. If any customization has been made to the analog output configuration, the default selections may not apply. ▲

Dual Range Mode

In the dual range mode, there are two independent analog outputs. These are labeled simply as the “High Range” and the “Low Range”. Each channel has its own analog output range, averaging time, and span coefficient.

This enables the sample concentration reading to be sent to the analog outputs at two different ranges. For example, the low NO analog output

can be set to output concentrations from 0 to 50 ppb and the high NO analog output set to output concentrations from 0 to 500 ppb.

In addition to each channel having two ranges, each channel has two span coefficients. There are two span coefficients so that each range can be calibrated separately. This is necessary if the two ranges are not close to one another. For example, the low NO range is set to 0–50 ppb and the high NO range is set to 0–20,000 ppb.

By default, in the dual range mode, the analog outputs are arranged on the rear panel connector as shown in [Figure 3–5](#). See [Table 3–3](#) for channels and pin connections. Dual range mode may be selected from the “[Range Mode Select](#)” on [page 3-76](#).

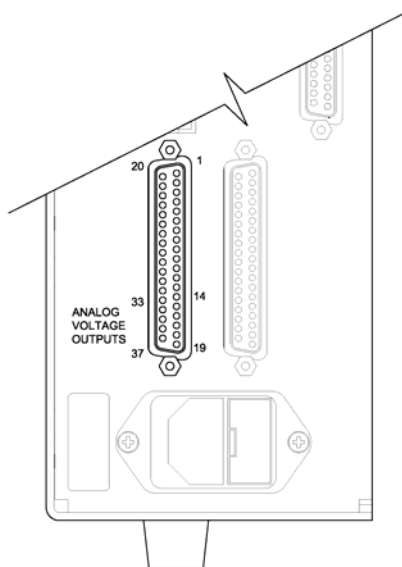

Figure 3–5. Pin-Out of Rear Panel Connector in Dual Range Mode

Table 3–3. Default Analog Outputs in Dual Range Mode

Channel	Connector Pin	I/O Terminal Pin	Description
1	14	1	NO High Range
2	33	3	NO Low Range
3	15	5	NO ₂ High Range
4	34	7	NO ₂ Low Range
5	17	9	NO _x High Range
6	36	11	NO _x Low Range
Ground	16, 18, 19, 35, 37	2, 4, 6, 8, 10, 12	Signal Ground

Note All channels are user definable. If any customization has been made to the analog output configuration, the default selections may not apply. ▲

Auto Range Mode

The auto range mode switches the NO, NO₂, and NO_x analog outputs between high and low ranges, depending on the NO_x concentration level. The high and low ranges are defined in the Range menu.

For example, suppose the low range is set to 20 ppb and the high range is set to 100 ppb (Figure 3–6). Sample concentrations below 50 ppb are presented to the low ranges analog outputs and sample concentrations above 50 ppb are presented to the high ranges analog outputs. When the low range is active, the status output is at 0 volts. When the high range is active, the status output is at half of full-scale.

When the high ranges are active, the NO_x concentration must drop to 95% of the low NO_x range for the low ranges to become active.

In addition to each channel having two ranges, each channel has two span coefficients. There are two span coefficients so that each range can be calibrated separately. This is necessary if the two ranges are not close to one another. For example, the low NO range is set to 0–50 ppb and the high NO range is set to 0–20,000 ppb.

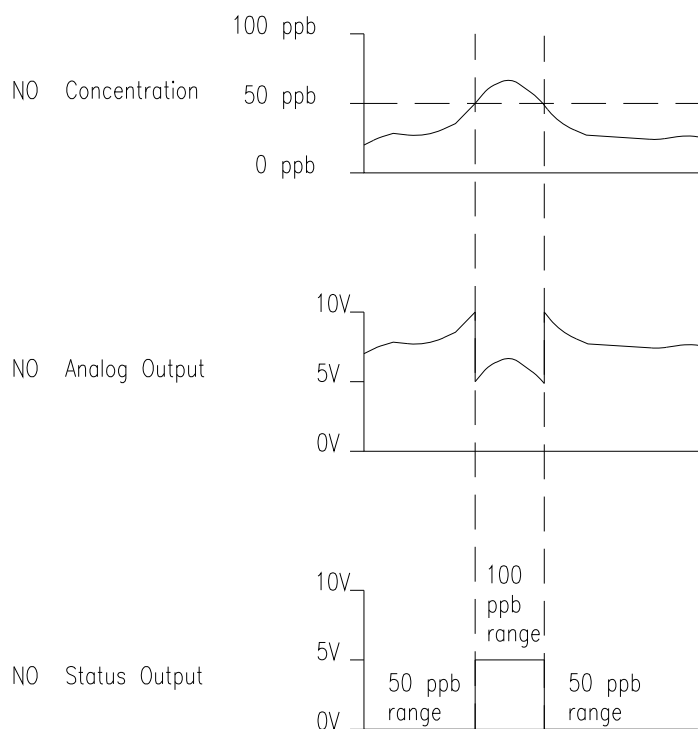

Figure 3–6. Analog Output in Auto Range Mode

By default, in the auto range mode, the analog outputs are arranged on the rear panel connector as shown in [Figure 3-7](#). See [Table 3-4](#) for channels and pin connections. Auto range mode may be selected from the “[Range Mode Select](#)” on page 3-76.

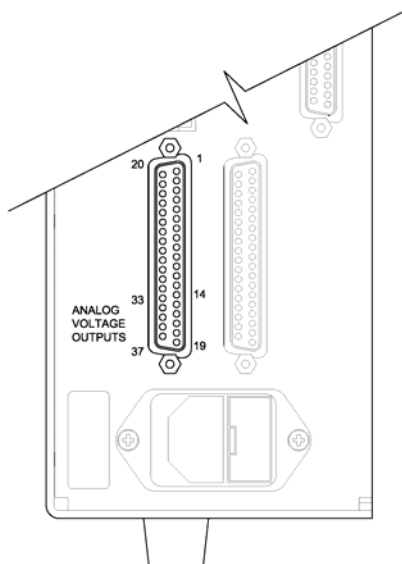

Figure 3-7. Pin-Out of Rear Connector in Auto Range Mode

Table 3-4. Default Analog Outputs in Auto Range Mode

Channel	Connector Pin	I/O Terminal Pin	Description
1	14	1	NO Analog Output
2	33	3	NO ₂ Analog Output
3	15	5	NO _x Analog Output
4	34	7	Range Status: half-scale = high range zero scale = low range
5	17	9	None
6	36	11	None
Ground	16, 18, 19, 35, 37	2, 4, 6, 8, 10, 12	Signal Ground

Note All channels are user definable. If any customization has been made to the analog output configuration, the default selections may not apply. ▲

Gas Units

The Gas Units screen defines how the NO, NO₂, and NO_x concentration readings are expressed. Gas units of parts per billion (ppb), parts per million (ppm), micrograms per cubic meter (µg/m³), or milligrams per cubic meter (mg/m³) are available. The µg/m³ and mg/m³ gas concentration modes are calculated using a standard pressure of 760 mmHg and a standard temperature of 20 °C.

When switching the selected units from ppb or ppm to µg/m³ or mg/m³, the analog ranges all default to the highest range in that mode. For example, when switching from mg/m³ to ppm, all the ranges default to 20 ppm. Therefore, whenever you change units, you should also check the range settings.

- In the Main Menu, choose Range > **Gas Units**.

Note If the units change from ppb/ppm to µg/m³/mg/m³ or vice versa, the instrument should be re-calibrated, particularly if the user's standard temperature is different from 20 °C. A display warning will appear that ranges will be defaulted and calibration parameters reset. ▲

```

GAS UNITS:
CURRENTLY:                PPB
SET TO:                    UG/M3 ?
AND SET RANGES AND CAL TO
DEFAULT SETTINGS
↑↓ CHANGE VALUE          ← SAVE
RANGE  AVG  DIAGS  ALARM
  
```

NO, NO₂, and NO_x Ranges

The NO, NO₂, and NO_x Ranges screen defines the concentration range of the analog outputs. For example, a NO₂ range of 0–50 ppb restricts the NO₂ analog output to concentrations between 0 and 50 ppb.

The display shows the current NO, NO₂, or NO_x range. The next line of the display is used to change the range. The range screen is similar for the single, dual, and auto range modes. The only difference between the screens are the words “High” and “Low” to indicate which range is displayed. The example below shows the NO range screen in single mode. For more information about the dual and auto range modes, see “[Single Range Mode](#)”, “[Dual Range Mode](#)”, and “[Auto Range Mode](#)” earlier in this chapter.

Table 3–5 lists the available operating ranges. Table 3–6 lists the extended ranges. When switching from standard to extended ranges, the PMT voltage must be readjusted. For more information about readjusting the PMT voltage, see Chapter 7, “Servicing”.

- In the Main Menu, choose Range > **NO, NO2, or NOx Range**.

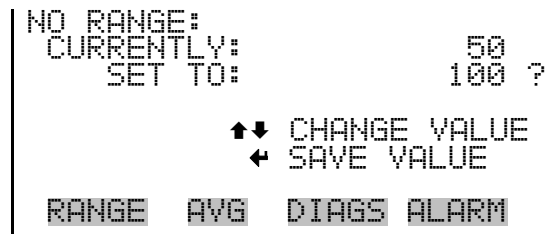

Table 3–5. Standard Ranges

ppb	ppm	µgm ³	mgm ³
50	0.05	100	0.1
100	0.10	200	0.2
200	0.20	500	0.5
500	0.50	1,000	1.0
1,000	1.00	2,000	2.0
2,000	2.00	5,000	5.0
5,000	5.00	10,000	10.0
10,000	10.00	20,000	20.0
20,000	20.00	30,000	30.0
C1	C1	C1	C1
C2	C2	C2	C2
C3	C3	C3	C3

Table 3–6. Extended Ranges

ppb	ppm	µgm ³	mgm ³
200	0.2	500	0.5
500	0.5	1,000	1
1,000	1	2,000	2
2,000	2	5,000	5
5,000	5	10,000	10
10,000	10	20,000	20
20,000	20	50,000	50
50,000	50	100,000	100
100,000	100	150,000	150
C1	C1	C1	C1
C2	C2	C2	C2
C3	C3	C3	C3

C1, C2, and C3 are custom ranges. For more information about custom ranges, see “Set Custom Ranges” below.

Set Custom Ranges

The Set Custom Ranges menu lists three custom ranges, which are user-defined. In the standard range mode, any value between 50 ppb (0.05 ppm) and 20,000 ppb (20 ppm) can be specified as a range. In the µg/m³ (mg/m³) mode, any value between 100 µg/m³ (0.1 mg/m³) and 30,000 µg/m³ (30 mg/m³) can be specified as a range. In the extended range mode, any value between 200 ppb (0.02 ppm) and 100,000 ppb (100 ppm) can be specified as a range. In the µg/m³ (mg/m³) mode, any value between 500 µg/m³ (0.5 mg/m³) and 150,000 µg/m³ (150 mg/m³) can be specified as a range.

- In the Main Menu, choose Range > **Set Custom Ranges**.

```

CUSTOM RANGES:
>CUSTOM RANGE 1      55.6
CUSTOM RANGE 2      75.0
CUSTOM RANGE 3     125.0

RANGE  AVG  DIAGS  ALARM
  
```

Custom Ranges

The Custom Ranges screen is used to define the custom ranges.

The display shows the current custom range. The next line of the display is used to set the range. To use the custom full-scale range, be sure to select it (Custom range 1, 2, or 3) in the NO, NO₂, or NO_x Ranges screen. For more information about selecting ranges, see “NO, NO₂, and NO_x Ranges” above.

- In the Main Menu, choose Range > Set Custom Ranges > **Custom Range 1, 2, or 3.**

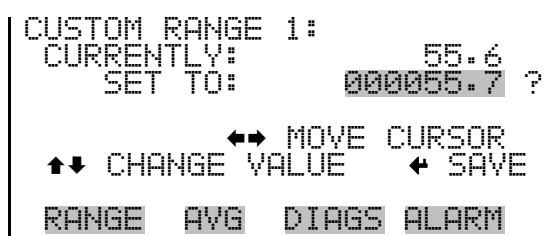

Averaging Time

The Averaging Time defines a time period (10 to 300 seconds) over which NO, NO₂, and NO_x measurements are taken. The average concentration of the NO, NO₂, and NO_x readings are calculated for that time period. The front panel display and analog outputs are updated every 10 seconds for averaging times between 10 and 300 seconds. An averaging time of 10 seconds, for example, means that the average concentration of the last 10 seconds will be output at each update. An averaging time of 300 seconds means that the moving average concentration of the last 300 seconds will be output at each update. Therefore, the lower the averaging time the faster the front panel display and analog outputs respond to concentration changes. Longer averaging times are typically used to smooth output data.

The Averaging Time screen for the single range mode is shown below. In the dual and auto range modes, an Averaging Time Menu is displayed before the averaging time screens. This additional menu is needed because the dual and auto range modes have two averaging times (high and low). The Averaging Time screen functions the same way in the single, dual, and auto range modes. The following averaging times are available: 10, 20, 30, 60, 90, 120, 180, 240, and 300 seconds. Additional averaging times are available in NO and NO_x modes: 1, 2, and 5 seconds. For more information about the manual mode, see “Auto/Manual Mode” later in this chapter.

- In the Main Menu, choose **Averaging Time.**

```

AVERAGING TIME:
CURRENTLY:      30 SEC
SET TO:        10 SEC ?

      ↑↓ CHANGE VALUE
      ← SAVE VALUE

RANGE  AVG  DIAGS  ALARM
  
```

Calibration Factors Menu

Calibration factors are used to correct the NO, NO₂, and NO_x concentration readings that the instrument generates using its own internal calibration data. The Calibration Factors menu displays the calibration factors. The screens below show the calibration factors menu in single mode and dual/auto range modes. The only difference between the screens are the words “HI” and “LO” to indicate which range is displayed.

Normally, the calibration factors are calculated automatically using the functions described in “[Calibration](#)” menu later in this chapter. However, the calibration factors can also be set manually using the functions in this menu.

- In the Main Menu, choose **Calibration Factors**.

```

CALIBRATION FACTORS:
>NO BKG          0.0
NOx BKG          0.0
NO COEF          1.000
NO2 COEF         1.000
NOx COEF         1.000↓

RANGE  AVG  DIAGS  ALARM
  
```

```

CALIBRATION FACTORS:
>NO BKG          0.0
NOx BKG          0.0
HI NO COEF       1.000
HI NO2 COEF      1.000
HI NOx COEF      1.000↓

RANGE  AVG  DIAGS  ALARM
  
```

RESET USER CAL DEFAULTS

```

LO NO COEF       1.000
LO NO2 COEF      1.000
LO NOx COEF      1.000
RESET USER CAL DEFAULTS
  
```







NO and NO_x Backgrounds

The NO and NO_x background corrections are determined during zero calibration. The NO background is the amount of signal read by the analyzer in the NO channel while sampling zero air. The NO_x background is the amount of signal read by the analyzer in the NO_x channel while sampling zero air. Although the background is expressed in terms of concentration, the background signal is actually the combination of electrical offsets, PMT dark currents, and trace substances undergoing chemiluminescence. Before the analyzer sets the NO and NO_x readings to zero, it stores these values as the NO and NO_x background corrections, respectively. The NO₂ background correction is determined from the NO

and NO_x background corrections and is not displayed. The background corrections are typically below 15 ppb.

The NO and NO_x Background screens are used to perform a manual zero calibration of the instrument. Before performing a manual zero adjustment, allow the analyzer to sample zero air until stable readings are obtained. The NO channel should be calibrated first. Both the NO and NO_x Background screens operate the same way. Therefore, the following description of the NO background applies to the NO_x background screen as well. The first line of the display shows the current NO reading. The second line of the display shows the NO background correction that is stored in memory. The NO background correction is a value, expressed in the current gas units, that is subtracted from the NO reading to produce the NO reading that is displayed.

In the example below, the analyzer is displayed 4.4 ppb of NO while sampling zero air. A background correction is 0.0 ppb means that 0 ppb is being subtracted from the NO concentration being displayed. Therefore, the background correction must be increased to 4.4 ppb in order for the NO reading to be at 0 ppb, that is, a NO reading of 4.4 ppb minus a NO background reading of 4.4 ppb gives the corrected NO reading of 0 ppb.

To set the NO reading in the following example to zero, use  to increment the NO background correction to 4.4 ppb. As the NO background correction is increased, the NO concentration is decreased. Note that at this point, pressing  and  has no effect on the analog outputs or the stored NO background correction of 0.0 ppb. A question mark following both the NO reading and the NO background correction indicates that these are proposed changes as opposed to implemented changes. To escape this screen without saving any changes, press  to return to the Calibration Factors menu or  to return to the Run screen. Press  to actually set the NO reading to 0 ppb and store the new background correction of 4.4 ppb. Then the question mark prompt beside the NO reading disappears.



- In the Main Menu, choose Calibration Factors > **NO** or **NO_x Bkg**.

```
NO BACKGROUND:
NO: 4.4
SET BKG TO: 0.00 ?
      ↑↓ INC/DEC
      ← SAVE VALUE
RANGE  AVG  DIAGS  ALARM
```

NO, NO₂, and NO_x Coefficients

The NO, NO₂, and NO_x span coefficients are usually calculated by the instrument processor during calibration. The span coefficients are used to correct the NO, NO₂, and NO_x readings. The NO and NO_x span coefficients normally has a value near 1.000. The NO₂ span coefficient normally has a value between 0.95 and 1.050.

The NO, NO₂, and NO_x Coefficient screens allow the NO, NO₂, and NO_x span coefficients to be manually changed while sampling span gas of known concentration. The NO, NO₂, and NO_x Coefficient screens operate the same way. Therefore, the following description of the NO coefficient screen applies to the NO₂, and NO_x coefficient screens as well.

The display shows the current NO concentration reading. The next line of the display shows the NO span coefficient that is stored in memory and is being used to correct the NO concentration. Notice that as the span coefficient value is changed, the current NO concentration reading on the above line also changes. However, no actual changes are made to the value stored in memory until  is pressed. Only proposed changes, as indicated by a question mark prompt, are displayed until  is pressed.

In dual or auto range modes, “HIGH” or “LOW” is displayed to indicate the calibration of the high or low coefficient. The example below shows the coefficient screen in dual/auto range mode.

Note The screen will show “SPAN CONC NOT VALID” if the coefficient change causes the concentration to be either higher than the selected range or less than or equal to zero. ▲

- In the Main Menu, choose Calibration Factors > NO, NO₂, or NO_x Coef.

```

NO COEFFICIENT:
NO:           51.4
SET COEF TO:  1.000

                ↑↓ INC/DEC
                ← SAVE VALUE

RANGE  AVG  DIAGS  ALARM
    
```

Reset User Calibration Defaults

The Reset User Calibration Defaults screen allows the user to reset the calibration factors to factory defaults.

- In the Main Menu, choose Calibration Factors > **Reset User Cal Defaults.**

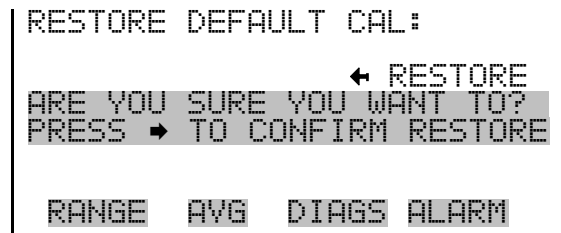
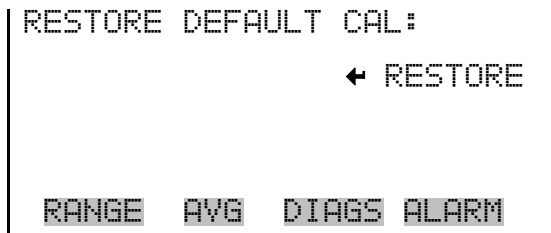

Calibration Menu

The Calibration menu is used to automatically set the zero background of NO and NO_x, and the NO, NO₂, and NO_x span coefficients. The screens below show the calibration menu in single mode and dual/auto range modes. The zero/span check is visible only if the zero/span option is installed.

The calibration procedure is the same in dual, auto, or single range, however, there are two sets of gas coefficients in dual or auto range (i.e. low and high coefficients). This enables each range to be calibrated separately. When calibrating the instrument in dual or auto range, be sure to use a low span gas to calibrate the low range and a high span gas to calibrate the high range.

- In the Main Menu, choose **Calibration**.



ZERO/SPAN CHECK

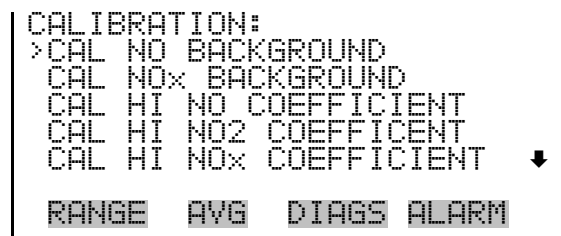

CAL LO NO COEFFICIENT
CAL HI NO2 COEFFICIENT
CAL HI NOx COEFFICIENT
ZERO/SPAN CHECK

Calibrate NO and NO_x Backgrounds

The Calibrate NO and NO_x Background screens are used to adjust the instrument zero, or background. Before making an adjustment, be sure the analyzer samples zero air until the readings stabilize. The display shows the current NO or NO_x reading.

It is important to note the averaging time when calibrating. The longer the averaging time, the more accurate the calibration will be. To be most

accurate, use the 300-second averaging time. For more information about calibration, see Chapter 4, “Calibration”.

- In the Main Menu, choose Calibration > **Calibrate NO** or **NO_x Background**.

```

NO BACKGROUND:
NO:           1.2
CURRENTLY:    0.00 ?
      ← SET CO TO ZERO

RANGE  AVG  DIAGS  ALARM
  
```

Calibrate NO, NO₂, and NO_x Coefficients

The Calibrate NO Coefficient screen is used to adjust the NO span concentration while sampling span gas of known concentration. All calibration screens operate the same way. Therefore, the following description of the NO calibration screen applies to the NO₂ and NO_x calibration screens as well.

The display shows the current NO concentration reading and the current NO range. The next line of the display is where the NO calibration gas concentration is entered.

It is important to note the averaging time when calibrating. The longer the averaging time, the more accurate the calibration will be. To be most accurate, use the 300-second averaging time. For more information about calibration, see Chapter 4, “Calibration”.

- In the Main Menu, choose Calibration > **Cal NO, NO₂ or NO_x Coefficient**.

```

CALIBRATE NO:
NO:           25.5
SPAN CONC:    0001.00 ?
      ↔ MOVE CURSOR
      ↑↓ CHANGE VALUE  ← SAVE

RANGE  AVG  DIAGS  ALARM
  
```

Zero/Span Check

The Zero/Span Check menu is available only if the zero/span valve option is installed. It is used to program the instrument to perform fully automated zero and span checks or adjustments.

- In the Main Menu, choose Calibration > **Zero/Span Check**.

```

ZERO/SPAN CHECK:
>NEXT TIME 01Jan06 12:00
PERIOD HR          24
TOTAL DURATION HR  1.5
ZERO DURATION MIN  30
SPAN DURATION MIN  30 ↓
RANGE  AVG  DIAGS  ALARM

PURGE DURATION MIN  30
ZERO/SPAN AVG SEC   60
ZERO CAL RESET      ON
SPAN CAL RESET      OFF
ZERO/SPAN RATIO     1
  
```

Next Time The Next Time screen is used to view and set the initial date and time (24-hour format) of the zero/span check. Once the initial zero/span check is performed, the date and time of the next zero/span check is calculated and displayed.

- In the Main Menu, choose Calibration > Zero/Span Check > **Next Time**.

```

NEXT DATE AND TIME:
19 MAR 2007 12:34
PRESS ← TO EDIT
RANGE  AVG  DIAGS  ALARM
  
```

```

NEXT DATE AND TIME:
19 MAR 2007 12:34 ?
SETTING:  DAYS
          → SET MONTHS
          ↑↓ CHANGE VALUE
          ← SAVE VALUE
RANGE  AVG  DIAGS  ALARM
  
```

Period Hours The Period Hours screen defines the period or interval between zero/span checks. Periods between 0 and 999 hours are acceptable. To turn the zero/span check off, set the period to 0.

- In the Main Menu, choose Calibration > Zero/Span Check > **Period HR**.

```

ZERO/SPAN PERIOD:
CURRENTLY:         024 HRS
SET TO:           025 HRS ?
                ↔ MOVE CURSOR
                ↑↓ CHANGE VALUE  ← SAVE
RANGE  AVG  DIAGS  ALARM
  
```

Total Duration Hour

The Total Duration Hour line is the sum of the zero, span, and purge duration minutes, and is for viewing only.

Zero/Span/Purge Duration Minutes

The Zero Duration Minutes screen defines how long zero air is sampled by the instrument. The Span and Purge Duration Minutes screens look and function the same way as the zero duration screen. The span duration screen is used to set how long the span gas is sampled by the instrument. The purge duration screen is used to set how long the purge period will be after doing a zero or span check. This gives the instrument time to flush out the zero and span gas before any meaningful data is taken. Logged data is flagged as taken during a purge to show that the data is suspect. Durations between 0 and 99 minutes are acceptable. Each time a zero/span check occurs the zero check is done first, followed by the span check. To perform just a zero check, set the span duration to 0 (off). The same applies to perform just a span check.

- In the Main Menu, choose Calibration > Zero/Span Check > **Zero, Span or Purge Duration Min.**

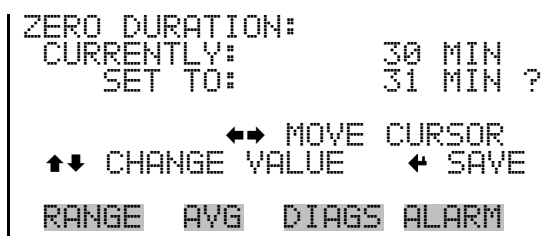

Zero/Span Averaging Time

The Zero/Span Averaging Time screen allows the user to set the zero/span averaging time. The zero/span averaging time is used by the analyzer only when performing an automatic zero or span check or adjustment. The analyzer's averaging time is used for all other functions. The following averaging times are available: 1, 2, 5, 10, 20, 30, 60, 90, 120, 180, 240, and 300 seconds.

- In the Main Menu, choose Calibration > Zero/Span Check > **Zero/Span Avg Sec.**

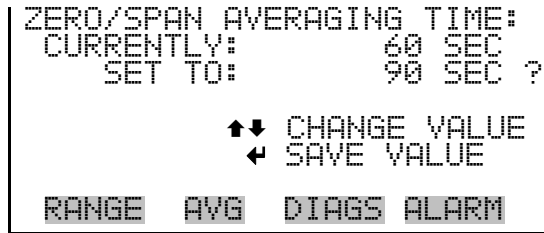

Zero/Span Calibration Reset

Zero and Span Calibration Reset are toggle items that change between yes or no when selected, and are displayed only if Auto Calibration is set to YES in the Instrument Configuration screen in the Diagnostics menu.

If the zero calibration reset line is set to yes, then not only is a zero check done, but a zero adjustment is made. If the span calibration reset line is set to yes, then not only is a span check done, but a span adjustment is made. (This is how to set up a scheduled, recurring auto calibration.)

Zero/Span Ratio

The Zero/Span Ratio screen is used to set the ratio of zero checks to span checks. For example, if this value is set to 1, a span check will follow every zero check. If this value is set to 3, there will be three zero checks between each span check. This value may be set from 1 to 10, with 1 as default.

- In the Main Menu, choose Calibration > Zero/Span Check > **Zero/Span Ratio**.

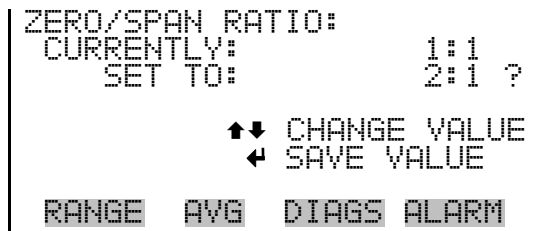

Instrument Controls Menu

The Instrument Controls menu contains a number of items that may be selected to control various instrument operational parameters. The software controls listed in this menu enable control of the listed instrument functions.

- In the Main Menu, choose **Instrument Controls**.

```

INSTRUMENT CONTROLS:
>OZONATOR
  PMT SUPPLY
  AUTO/MANUAL MODE
  DATALOGGING SETTINGS
  COMMUNICATION SETTINGS ↓
RANGE  AVG  DIAGS  ALARM

I/O CONFIGURATION
TEMPERATURE COMPENSATION
PRESSURE COMPENSATION
SCREEN CONTRAST
SERVICE MODE
DATE/TIME
TIMEZONE
  
```

Ozonator

The Ozonator screen is used to turn the internal ozonator on or off. The display shows the status of the control line that turns the ozonator on or off. The next line of the display shows the user-specified ozonator setting. Under most conditions, the control line status and ozonator set status are the same. However, as a safety precaution, the microprocessor can override the user-specified ozonator setting. This occurs only if the ozonator flow doesn't indicate any flow or if the NO₂ converter temperature is below the minimum alarm limit. In this case, an alarm is activated and the ozonator is turned off. This is done to prevent the ozonator from overheating, which will result in permanent damage to the ozonator, or if the converter temperature drops below the minimum limit, which reduces the effectiveness of the ozone destruct.

It is possible, however, to override the ozonator shut-off due to converter temperature being out of range, by setting the ozonator safety "OFF" in the "Service Mode".

Note The ozonator must be "ON" to obtain NO, NO₂, and NO_x readings. As an additional safety precaution, a lit LED mounted on the measurement interface board indicates that the ozonator is on. ▲

- In the Main Menu, choose Instrument Controls > **Ozonator**.

```

OZONATOR:
CURRENTLY:                OFF
SET TO:                   ON ?
                            ← TOGGLE VALUE
RANGE  AVG  DIAGS  ALARM
  
```

PMT Supply

The PMT Supply screen is used to turn the PMT power supply on or off. This is useful in a troubleshooting situation.

- In the Main Menu, choose Instrument Controls > **PMT Supply**.

```
PMT SUPPLY:
CURRENTLY:      OFF
SET TO:         ON ?
                ← TOGGLE VALUE
RANGE  AVG  DIAGS  ALARM
```

Auto/Manual Mode

The Auto/Manual Mode screen allows selection of the automatic mode (NO/NO_x), NO mode (manual NO), or NO_x mode (manual NO_x). The auto cycle mode switches the mode solenoid valve automatically on a 10 second cycle so that NO, NO₂, and NO_x concentrations are determined. The manual NO mode puts the mode solenoid valve into the open position so that the sample gas bypasses the NO₂-to-NO converter. Therefore, only the NO concentration is determined. The manual NO_x mode puts the mode solenoid valve into the closed position so that the sample gas passes through the NO₂-to-NO converter. Therefore, only the NO_x concentration is determined. In the manual modes, additional averaging times of 1, 2, and 5 seconds are available from the Averaging Times screen.

- In the Main Menu, choose Instrument Controls > **Auto/Manual Mode**.

```
MODE:
CURRENTLY:      MANUAL NO
SET TO:         NO/NOX ?
                ↑↓ CHANGE VALUE
                ← SAVE VALUE
RANGE  AVG  DIAGS  ALARM
```

Datalogging Settings

The *iSeries* instruments include a built-in datalogging capability as a standard feature. The operator is allowed to create two different types of records, which for historical reasons, are named lrecs and srecs. Each record can contain up to 32 different fields, or data items, and records can be created at user-defined intervals ranging from 1 to 60 minutes.

Record generation is tied to the instrument's real-time clock. For example, if the logging period for srecs is set to 30 minutes, a new srec will be generated on every hour and every half hour (10:00, 10:30, 11:00 ...). Lrecs and srecs function independent of each other. For example, an srec containing just the current concentration level could be generated every five minutes while an lrec containing a full set of diagnostic data could be generated once every hour.

The analyzer's computer system includes three megabytes of flash memory which is enough to store a full lrec containing 32 data items and a full srec containing 32 items once each minute for a week (>20,000 total records). If logging is limited to the minimum content of date, time, concentration and error flags, the analyzer can store data once each minute for 4 months (>190,000 total records).

The Datalogging Settings menu allows the user flexibility in how data is stored and recorded.

- In the Main Menu, choose Instrument Controls > **Datalogging Settings**.

```

DATALOGGING SETTINGS:
>SELECT SREC/LREC      SREC
VIEW LOGGED DATA
ERASE LOG
SELECT CONTENT
COMMIT CONTENT
                                ↓
RANGE  AVG  DIAGS  ALARM

RESET TO DEFAULT CONTENT
CONFIGURE DATALOGGING
    
```

Select Srec/Lrec

The Select Srec/Lrec screen is used to select the log record type for other operations in this menu.

- In the Main Menu, choose Instrument Controls > Datalogging Settings > **Select Srec/Lrec**.

```

SELECT LOG TYPE:
CURRENTLY:      SREC
SET TO:         LREC ?
                ← TOGGLE VALUE
RANGE  AVG  DIAGS  ALARM
    
```

View Logged Data

The View Logged Data screen is used to select the starting point to view the logged data by the number of records or by date and time. Note that both types of records cannot be viewed at the same time, only the selected record type.

- In the Main Menu, choose Instrument Controls > Datalogging Settings > **View Logged Data**.

```
SELECT START POINT BY:
      SET TO: # OF RECS
      ↑↓ CHANGE      ← ACCEPT
RANGE  AVG  DIAGS  ALARM
```

Number of Records

The Number of Records screen is used to select the number of records to view, ending with the most recent. It also shows the total number of records that have been logged for the selected record type.

```
SET # BACK FROM CURRENT:
TOTAL LRECS:           00000000
                        20
      ↔ MOVE CURSOR
      ↑↓ CHANGE VALUE  ← SAVE
RANGE  AVG  DIAGS  ALARM
```

The Record Display screen (read only) displays the selected records.

```
time    date    flags
10:01  01/20/07  FC0088900
10:02  01/20/07  FC0088900
10:03  01/20/07  FC0088900
10:04  01/20/07  FC0088900
      ↑↓ PGUP/DN    ↔ PAN L/R
RANGE  AVG  DIAGS  ALARM
```

Date and Time

The Date and Time screen is used to set a start date and time for which to view logged data. For example, if “20 Jan 2007 10:00” is entered, then the

first logged data record that is displayed is the first record after this time. If set to one minute logging, this would be at “20 Jan 2007 10:01”.

```

DATE AND TIME:
20 JAN 2007 10:00
↑↓ CHG DAYS
→ SET CURSOR TO MONTHS
← ACCEPT AS SHOWN

RANGE  AVG  DIAGS  ALARM
    
```

The Record Display screen (read only) displays the selected records.

```

time  date  flags
10:01 01/20/07 FC0088900
10:02 01/20/07 FC0088900
10:03 01/20/07 FC0088900
10:04 01/20/07 FC0088900
↑↓ PGUP/DN  ↔ PAN L/R

RANGE  AVG  DIAGS  ALARM
    
```

Erase Log The Erase Log screen is used to erase all saved data for the selected record type only (not both srecs and lrecs).

- In the Main Menu, choose Instrument Controls > Datalogging Settings > **Erase Log**.

```

ERASE LREC LOG FILE DATA?
                               ← ERASE

RANGE  AVG  DIAGS  ALARM
    
```

```

ERASE LREC LOG FILE DATA?
                               ← ERASE
ARE YOU SURE YOU WANT TO?
PRESS → TO CONFIRM ERASURE

RANGE  AVG  DIAGS  ALARM
    
```

Select Content The Select Content submenu displays a list of 32 record fields to use to configure the data to be logged. When a field is selected, a submenu list appears of the items to choose from to assign to those fields. Item types are Concentrations, Other Measurements, and Analog Inputs (if the I/O expansion board is installed). These record fields comprise a temporary list of items for the selected record type that must be committed via the

datalogging menu before the changes will apply. Note that committing any changes to this list will erase all currently logged data for the selected record type only, as the format of the stored data is changed.

- In the Main Menu, choose Instrument Controls > Datalogging Settings > **Select Content**.

```
LREC FIELDS:
>FIELD 1          NO
FIELD 2          NOX
FIELD 3          PRES
FIELD 4          PMTT
FIELD 5          INTT ↓
RANGE  AVG  DIAGS  ALARM
```

Choose Field Data

The Choose Field Data submenu displays a list of the types of data that can be logged for the current field. Choices are Concentrations, Other Measurements, and Analog Inputs (if the I/O expansion board is installed).

- In the Main Menu, choose Instrument Controls > Datalogging Settings > Select Content > **Field 1–32**.

```
DATA IN SREC FIELD 1:
>CONCENTRATIONS
OTHER MEASUREMENTS
ANALOG INPUTS
RANGE  AVG  DIAGS  ALARM
```

Note The ANALOG INPUTS item is only displayed if the I/O expansion board option is installed. ▲

Concentrations

The Concentrations screen allows the user to assign one of the concentrations to the selected record field. The selected item is shown by “<--” after it. Note that at this point, pressing  indicates that these are proposed changes as opposed to implemented changes. To change the selected record format and erase record log file data, see “[Commit Content](#)” below. Range (NO_x) is only visible in auto range mode.

- In the Main Menu, choose Instrument Controls > Datalogging Settings > Select Content > select Field > **Concentrations**.

```

CONCENTRATIONS:
>NONE
NO
NO2
NOx
LO NO
                                <--
                                ↓
RANGE  AVG  DIAGS  ALARM

LO NO2
LO NOx
HI NO
HI NO2
HI NOx
RANGE (NOX)

```

Other Measurements

The Other Measurements screen allows the user to assign one of the other available measurement types to the selected record field. The selected item is shown by “<--” after it. Note that at this point, pressing  indicates that these are proposed changes as opposed to implemented changes. To change the selected record format and erase record log file data, see “Commit Content” below. BKG and COEF items are displayed only if Output Conc Cal option is set to YES in the Instrument Configuration screen.

- In the Main Menu, choose Instrument Controls > Datalogging Settings > Select Content > select Field > **Other Measurements**.

```

OTHER MEASUREMENTS:
>NONE
INT TEMP
CHAMBER TEMP
COOLER TEMP
NO2 CNV TEMP
                                ↓
RANGE  AVG  DIAGS  ALARM

PERM OVN GAS
PERM OVN HTR
CHAMBER PRES
FLOW
PMT VOLTS
NO BKG
NOx BKG
LO NO COEF
LO NO2 COEF
LO NOx COEF
HI NO COEF
HI NO2 COEF
HI NOx COEF
OZONATOR FLOW
EXT ALARMS

```

Analog Inputs

The Analog Inputs screen allows the user to select the parameter (none or analog inputs 1–8) to the selected record field. The selected item is shown by “<--” after it. Note that at this point, pressing  indicates that these are proposed changes as opposed to implemented changes. To change the selected record format and erase record log file data, see “Commit Content” below. The analog inputs 1–8 will not show if the Output Conc Cal option is set to YES in the Instrument Configuration screen.

- In the Main Menu, choose Instrument Controls > Datalogging Settings > Select Content > select Field > **Analog Inputs**.

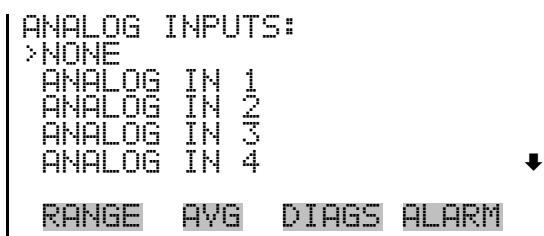

Commit Content

The Commit Content screen is used to save any changes that have been made to any of the record fields for the selected record type. Saving changes will erase record log file data for that record type. If no changes have been made “NO CHANGES TO RECORD LIST!” will appear. For more information about selecting the content of logged data fields, see “Select Content” above.

- In the Main Menu, choose Instrument Controls > Datalogging Settings > **Commit Content**.



Reset to Default Content

The Reset to Default Content screen is used to reset all of the datalogging field items to default values for the selected record type. For more information about selecting the content of logged data fields, see “Select Content” above.

- In the Main Menu, choose Instrument Controls > Datalogging Settings > **Reset to Default Content**.

```

RESET LREC DATA AND
ERASE LREC LOG FILE DATA?
          ← RESET

RANGE  AVG  DIAGS  ALARM
  
```

```

RESET LREC DATA AND
ERASE LREC LOG FILE DATA?
          ← RESET
ARE YOU SURE YOU WANT TO?
PRESS → TO CONFIRM RESET

RANGE  AVG  DIAGS  ALARM
  
```

Configure Datalogging

The Configure Datalogging menu deals with datalogging configuration for the currently selected record type.

- In the Main Menu, choose Instrument Controls > Datalogging Settings > **Configure Datalogging**.

```

DATALOGGING SETTINGS:
>LOGGING PERIOD MIN      60
MEMORY ALLOCATION %      50
DATA TREATMENT          AVG

RANGE  AVG  DIAGS  ALARM
  
```

Logging Period Min

The Logging Period Min screen is used to select the logging period in minutes for the selected record format (srec or lrec). List of choices include: off, 1, 5, 15, 30, and 60 minutes (default).

- In the Main Menu, choose Instrument Controls > Datalogging Settings > Configure Datalogging > **Logging Period Min**.

```

SET PERIOD FOR SREC:
CURRENTLY:      60 MIN
SET TO:        OFF MIN ?

↑↓ CHANGE VALUE  ← SAVE

RANGE  AVG  DIAGS  ALARM
  
```

Memory Allocation Percent

The Memory Allocation Percent screen is used to select the percentage of total memory that may be used by the selected record type (lrecs or srecs).

Percentages between 0 and 100% are available in increments of 10. Changing this value results in log erasure for both types of records, and changing the percent allocated to one record type will automatically change the other.

- In the Main Menu, choose Instrument Controls > Datalogging Settings > Configure Datalogging > **Memory Allocation %**.

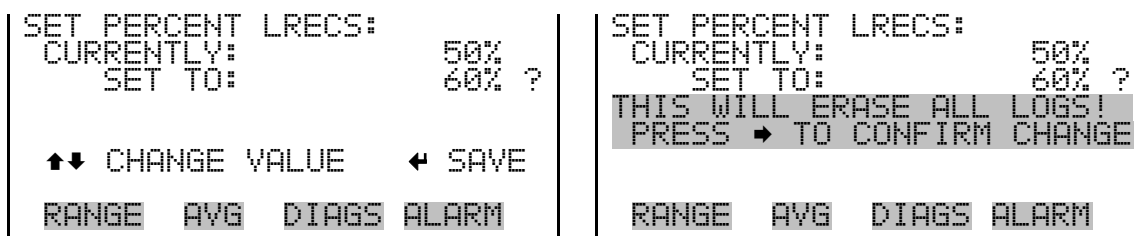

Data Treatment

The Data Treatment screen is used to select the data type for the selected record type: whether the data should be averaged over the interval, the minimum or maximum measured during the interval, or the current value (last value measured). Data treatment doesn't apply to all data, just to the concentration measurement. All other data points log the current value at the end of the interval.

Note This feature is found in all *i*Series instruments, but it is recommended that the data type be set to ONLY the current value (cur), as the datalogging averaging is done in addition to the normal concentration averaging. ▲

- In the Main Menu, choose Instrument Controls > Datalogging Settings > Configure Datalogging > **Data Treatment**.

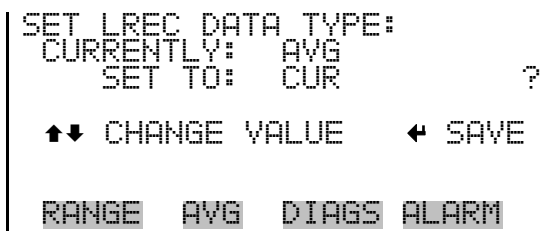

Communication Settings

The Communication Settings menu is used for communications control and configuration.

- In the Main Menu, choose Instrument Controls > **Communication Settings**.

```

COMMUNICATION SETTINGS:
>SERIAL SETTINGS
  INSTRUMENT ID
  COMMUNICATION PROTOCOL
  STREAMING DATA CONFIG
  TCP/IP SETTINGS

RANGE  AVG  DIAGS  ALARM
  
```

Serial Settings

The Serial Setting submenu is used for serial communications control and configuration.

- In the Main Menu, choose Instrument Controls > Communication Settings > **Serial Settings**.

```

SERIAL SETTINGS:
>BAUD RATE           9600
  DATA BITS         8
  PARITY             NONE
  STOP BITS          1
  RS-232/485 SEL     RS-232

RANGE  AVG  DIAGS  ALARM
  
```

Baud Rate

The Baud Rate screen is used to set the RS-232/RS-485 interface baud rate. Baud rates of 1200, 2400, 4800, 9600, 19200, 38400, 57600, and 115200 are available. The analyzer's default baud rate is set to 9600 to provide backwards compatibility with the older C-series analyzers.

- In the Main Menu, choose Instrument Controls > Communication Settings > Serial Settings > **Baud Rate**.

```

BAUD RATE:
  CURRENTLY:         9600
  SET TO:            19200 ?

      ↑↓ CHANGE VALUE
      ← SAVE VALUE

RANGE  AVG  DIAGS  ALARM
  
```

Data Bits

The Data Bits screen is used to set the number of serial data bits to either 7 or 8 (default).

Operation

Instrument Controls Menu

- In the Main Menu, choose Instrument Controls > Communication Settings > Serial Settings > **Data Bits**.

```
DATA BITS:
CURRENTLY:      8
SET TO:         7 ?
                ↑↓ CHANGE VALUE
                ←  SAVE VALUE
RANGE  AVG  DIAGS  ALARM
```

Parity The Parity screen is used to select the parity bit for the serial port to None (default), Even, or Odd.

- In the Main Menu, choose Instrument Controls > Communication Settings > Serial Settings > **Parity**.

```
PARITY:
CURRENTLY:      NONE
SET TO:         ODD ?
                ↑↓ CHANGE VALUE
                ←  SAVE VALUE
RANGE  AVG  DIAGS  ALARM
```

Stop Bits The Stop Bits screen is used to set the number of stop bits for the serial port to 1 (default) or 2.

- In the Main Menu, choose Instrument Controls > Communication Settings > Serial Settings > **Stop Bits**.

```
STOP BITS:
CURRENTLY:      1
SET TO:         2 ?
                ↑↓ CHANGE VALUE
                ←  SAVE VALUE
RANGE  AVG  DIAGS  ALARM
```

RS-232/RS-485 Selection

The RS-232/RS-485 Selection screen allows the user to choose between the RS-232 or RS-485 specification for serial communication.



Equipment Damage Disconnect the serial cable before changing the RS-232 and RS-485 selection to prevent damage to any equipment currently connected to the analyzer. ▲

- In the Main Menu, choose Instrument Controls > Communication Settings > Serial Settings > **RS-232/485 Selection**.

```

RS-232/RS-485 SELECTION:
** WARNING **
DISCONNECT THE SERIAL
CABLES BEFORE CHANGING
THE SELECTION!
      ← TO CONTINUE

RANGE  AVG  DIAGS  ALARM
  
```

```

RS-232/RS-485 SELECTION:
CURRENTLY:      RS-232
SET TO:        RS-485 ?
MAKE SURE THAT THE CABLE
IS OFF: PRESS → TO CONFIRM
      ← TOGGLE VALUE

RANGE  AVG  DIAGS  ALARM
  
```

Instrument ID

The Instrument ID screen allows the operator to edit the instrument ID number. The ID is used to identify the instrument when using the C-Link or MODBUS protocols to control the instrument or collect data. It may be necessary to edit the ID number if two or more instruments of the same model are connected to one computer. Valid Instrument ID numbers are from 0 to 127. The Model 42*i* has a default Instrument ID of 42. For more information about the Instrument ID, see Appendix B “[C-Link Protocol Commands](#)” or Appendix C “[MODBUS Protocol](#)”.

- In the Main Menu, choose Instrument Controls > Communication Settings > **Instrument ID**.

```

INSTRUMENT ID:
CURRENTLY:      42
SET TO:        50 ?

      ↑↓ CHANGE VALUE
      ← SAVE VALUE

RANGE  AVG  DIAGS  ALARM
  
```

Communication Protocol

The Communication Protocol screen is used to change the protocol for serial communications. Possible choices include: C-Link, MODBUS, Geysitech, and Streaming Data.

- In the Main Menu, choose Instrument Controls > Communication Settings > **Communication Protocol**.

```
COMMUNICATION PROTOCOL:
CURRENTLY: CLINK
SET TO: STREAMING ?

      ↑↓ CHANGE VALUE
      ← SAVE VALUE

RANGE  AVG  DIAGS  ALARM
```

Streaming Data Configuration The Streaming Data Configuration menu is used to allow for configuration of the 8 streaming data output items, streaming interval, current data format, and current timestamp setting. The Choose Stream Data submenu displays a list of the analog output signal group choices to choose from. Choices are Concentrations, Other Measurements, and Analog Inputs (if the I/O expansion board option is installed).

Note The selected item list is different depending on the AUTO/MANUAL MODE and RANGE MODE settings. Changing either of these settings will produce a different set of streaming data items. If either of these modes is going to be changed on a regular basis, then the user must configure each set of data separately after changing the modes to each setting. ▲

- In the Main Menu, choose Instrument Controls > Communication Settings > **Streaming Data Config**.

```
STREAMING DATA CONFIG
>INTERVAL          10 SEC
ADD LABELS         NO
PREPEND TIMESTAMP  YES
ADD FLAGS          YES
ITEM 1             NO ↓

RANGE  AVG  DIAGS  ALARM
```

Streaming Data Interval The Streaming Data Interval screen is used to adjust how frequently a new record will be generated. The following interval times are available: 1, 2, 5, 10, 20, 30, 60, 90, 120, 180, 240, and 300 seconds.

- In the Main Menu, choose Instrument Controls > Communication Settings > Streaming Data Config > **Interval**.

```

STREAMING DATA INTERVAL:
CURRENTLY:          10 SEC
SET TO:            20 SEC ?

      ↑↓ CHANGE VALUE
      ← SAVE VALUE

RANGE  AVG  DIAGS  ALARM
  
```

Note Add Labels, Prepend Timestamp, and Add Flags are toggle items that change between yes or no when selected. ▲

Choose Stream Data

The Choose Stream Data screen displays a list of the types of data that can be sent via streaming data. Choices are Concentrations, Other Measurements, and Analog Inputs (if the I/O expansion board is installed).

- In the Main Menu, choose Instrument Controls > Communication Settings > Streaming Data Config > **Item 1–8**.

```

CHOOSE STREAM DATA:
>CONCENTRATIONS
OTHER MEASUREMENTS
ANALOG INPUTS

RANGE  AVG  DIAGS  ALARM
  
```

Concentrations

The Concentrations screen allows the user to assign one of the concentrations to the selected streaming data item. The currently selected item is shown by “<--” after it. Once an item is selected, pressing  will save the selected streaming data item. In dual or auto range mode, “HI” or “LO” is displayed to indicate high or low range concentrations. Rang (NO_x) is visible only in auto range mode.

- In the Main Menu, choose Instrument Controls > Communication Settings > Streaming Data Config > select Item > **Concentrations**.

```

CONCENTRATIONS:
>NONE
NO
NO2
NOx
RANGE (NOX)
                                <--

RANGE  AVG  DIAGS  ALARM
  
```

Other Measurements

The Other Measurements screen allows the user to assign one of the other available measurement types to the selected streaming data item. The currently selected item is shown by “<--” after it. Once an item is selected, pressing  will save the selected streaming data item. BKG and COEF items are displayed only if Output Conc Cal option is set to YES in the Instrument Configuration screen.

- In the Main Menu, choose Instrument Controls > Communication Settings > Streaming Data Config > Select Item > **Other Measurements**.

```
OTHER MEASUREMENTS:
>NONE
INT TEMP
CHAMBER TEMP
COOLER TEMP
NO2 CNV TEMP
                                     ↓
RANGE  AVG  DIAGS  ALARM

CHAMBER PRES
FLOW
PMT VOLTS
NO BKG
NOx BKG
LO NO COEF
LO NO2 COEF
LO NOx COEF
HI NO COEF
HI NO2 COEF
HI NOx COEF
OZONATOR FLOW
EXT ALARMS
```

Analog Inputs

The Analog Inputs screen allows the user to assign an analog input signal (none or analog inputs 1–8) to the selected streaming data item. The currently selected item is shown by “<--” after it. Once an item is selected, pressing  will save the selected streaming data item. The analog inputs 1–8 will not show if the Output Conc Cal option is set to YES in the Instrument Configuration screen.

- In the Main Menu, choose Instrument Controls > Communication Settings > Streaming Data Config > Select Item > **Analog Inputs**.

```

ANALOG INPUTS:
>NONE
ANALOG IN 1
ANALOG IN 2
ANALOG IN 3
ANALOG IN 4
                                     ↓
RANGE  AVG  DIAGS  ALARM
  
```

TCP/IP Settings

The TCP/IP Settings menu is used for defining parameters that are required for Ethernet communications.

Note The instrument power must be cycled after any of these parameters have been changed for the change to take effect. ▲

- In the Main Menu, choose Instrument Controls > Communication Settings > **TCP/IP Settings**.

```

TCP/IP SETTINGS:
>USE DHCP                OFF
IP ADDR                 10.209.43.237
NETMASK                 255.255.254.0
GATEWAY                 10.209.42.1
HOST NAME                iSeries ↓
RANGE  AVG  DIAGS  ALARM
NTP SVR  10.209.43.237
  
```

Use DHCP

The Use DHCP screen is used to specify whether to use Dynamic Host Configuration Protocol (DHCP) or not. When DHCP is enabled, the network dynamically provides an IP address for the instrument.

- In the Main Menu, choose Instrument Controls > Communication Settings > TCP/IP Settings > **Use DCHP**.

```

DHCP:
CURRENTLY:                OFF
SET TO:                   ON ?
                                ← TOGGLE VALUE
CYCLE POWER TO CHANGE DHCP
RANGE  AVG  DIAGS  ALARM
  
```

IP Address The IP Address screen is used to edit the IP address. The IP address can only be changed when DHCP is off. If DHCP is on, the instrument will respond with “NOT SETTABLE IF DHCP IS ON”. For more information on DHCP, see “[Use DHCP](#)” above.

- In the Main Menu, choose Instrument Controls > Communication Settings > TCP/IP Settings > **IP Address**.

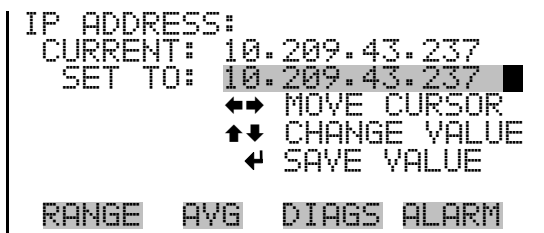

Netmask The Netmask screen is used to edit the netmask. The netmask is used to determine the subnet on which the instrument can directly communicate to other devices. The netmask can only be changed when DHCP is off. If DHCP is on, the instrument will respond with “NOT SETTABLE IF DHCP IS ON”. For more information on DHCP, see “[Use DHCP](#)” above.

- In the Main Menu, choose Instrument Controls > Communication Settings > TCP/IP Settings > **Netmask**.

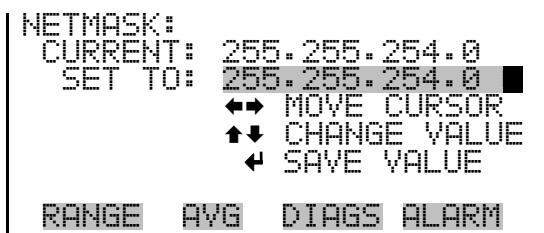

Default Gateway The Default Gateway screen is used to edit the gateway address. The default gateway can only be changed when DHCP is off. If DHCP is on, the instrument will respond with “NOT SETTABLE IF DHCP IS ON”. For more information on DHCP, see “[Use DHCP](#)” above. Any traffic to addresses that are not on the local subnet will be routed through this address.

- In the Main Menu, choose Instrument Controls > Communication Settings > TCP/IP Settings > **Gateway**.

```

DEFAULT GATEWAY:
CURRENT: 10.209.42.1
SET TO: 10.209.42.1
      ← MOVE CURSOR
      ↑↓ CHANGE VALUE
      ← SAVE VALUE

RANGE  AVG  DIAGS  ALARM
  
```

Host Name

The Host Name screen is used to edit the host name. When DHCP is enabled, this name is reported to the DHCP server.

- In the Main Menu, choose Instrument Controls > Communication Settings > TCP/IP Settings > **Host Name**.

```

HOST NAME:
CURRENT:  I SERIES
      I SERIES ?
      ABCDEFGHIJKLMNOP BKSP
      OPQRSTUVWXYZ PAGE
      0123456789 ./- SAVE

RANGE  AVG  DIAGS  ALARM
  
```

Network Time Protocol Server

The Network Time Protocol (NTP) Server screen is used to edit the IP address of the NTP server. An NTP server may be used to periodically synchronize the instrument's real-time clock with a standard. More information about the NTP servers and a list of public servers may be found at <http://www.ntp.org>.

- In the Main Menu, choose Instrument Controls > Communication Settings > TCP/IP Settings > **NTP Svr.**

```

NTP SERVER IP ADDRESS:
CURRENT: 10.209.43.237
SET TO: 10.209.43.237
      ← MOVE CURSOR
      ↑↓ CHANGE VALUE
      ← SAVE VALUE

RANGE  AVG  DIAGS  ALARM
  
```

I/O Configuration

The I/O Configuration menu deals with configuration of the analyzer's I/O system. The analog input configuration is displayed only if the I/O expansion board option is installed.

Operation

Instrument Controls Menu

- In the Main Menu, choose Instrument Controls > **I/O Configuration**.

```
I/O CONFIGURATION:
>OUTPUT RELAY SETTINGS
DIGITAL INPUT SETTINGS
ANALOG OUTPUT CONFIG
ANALOG INPUT CONFIG

RANGE  AVG  DIAGS  ALARM
```

Output Relay Settings

The Output Relay Settings menu displays a list of the 10 digital output relays available, and allows the user to select the logic state or instrument parameter for the relay selected.

Note The digital outputs may take up to one second after the assigned state occurs to show up on the outputs. ▲

- In the Main Menu, choose Instrument Controls > I/O Configuration > **Output Relay Settings**.

```
OUTPUT RELAY SETTINGS:
>1  NOP          GEN ALARM
2  NOP          LOCAL/REMOTE
3  NOP          UNITS
4  NOP          CONC ALARM
5  NOP          NONE ↓

RANGE  AVG  DIAGS  ALARM
```

Logic State

The Logic State menu item is used to change the selected I/O relay to either normally open or normally closed. The default state is open, which indicates that a relay connected between the digital output pin and ground is normally open and closes to trigger the digital output action.

- Press  to toggle and set the logic state open or closed.

```
OUTPUT RELAY SETUP:
>LOGIC STATE      OPEN
INSTRUMENT STATE

RANGE  AVG  DIAGS  ALARM
```

Instrument State The Instrument State submenu allows the user to select the instrument state that is assigned to the selected relay output. A submenu lists signal types of either alarm or non-alarm to choose from.

- In the Main Menu, choose Instrument Controls > I/O Configuration > Output Relay Settings > Select Relay > **Instrument State**.

```
CHOOSE SIGNAL TYPE:
>ALARMS
NON-ALARM

RANGE  AVG  DIAGS  ALARM
```

Alarms The Alarms screen allows the user to select an alarm status for the selected relay output. The currently selected item is shown by “<--” after it. The I/O board status alarm is only present if the I/O expansion board is installed. Zero and Span Check Cal are only present if the automated zero/span check is enabled. See the Alarms Menu section later in this chapter for more information on alarm items.

- In the Main Menu, choose Instrument Controls > I/O Configuration > Output Relay Settings > Select Relay > Instrument State > **Alarms**.

Operation

Instrument Controls Menu

```
ALARM STATUS ITEMS:
>NONE
GEN ALARM
NO CONC MAX
NO CONC MIN
NO2 CONC MAX
RANGE  AVG  DIAGS  ALARM

NO2 CONC MIN
NOx CONC MAX
NOx CONC MIN
INT TEMP
CHAMB TEMP
COOLER TEMP
NO2 CV TEMP
PRESSURE
FLOW
OZONE FLOW
MB STATUS
MIB STATUS
I/O BD STATUS
CONC ALARM
ZERO CHK/CAL
SPAN CHK/CAL
EXT ALARM 1
EXT ALARM 2
EXT ALARM 3
```

Non-Alarm

The Non-Alarm screen allows the user to select a non-alarm status for the selected relay output. The currently selected item is shown by “<--” after it. The zero, span, and sample modes are only present if the zero/span valve option is installed.

- In the Main Menu, choose Instrument Controls > I/O Configuration > Output Relay Settings > select Relay > Instrument State > **Non-Alarm**.

```
NON ALARM STATUS ITEMS:
>NONE
AUTORANGE (NOx)
LOCAL/REMOTE
SERVICE
UNITS
RANGE  AVG  DIAGS  ALARM

ZERO MODE
SPAN MODE
NO MODE
NOx MODE
SAMPLE MODE
PURGE MODE
```

Digital Input Settings

The Digital Input Settings menu displays a list of the 16 digital inputs available, and allows the user to select the logic state and instrument parameter for the relay selected.

Note The digital inputs must be asserted for at least one second for the action to be activated. ▲

Not all of the I/O available in the instrument is brought out on the supplied terminal board. If more I/O is desired, an alternative means of connection is required. (See optional [Terminal Block and Cable Kits.](#)) ▲

- In the Main Menu, choose Instrument Controls > I/O Configuration > **Digital Input Settings.**

```

DIGITAL INPUT SETTINGS:
>1  NOP          NO MODE
 2  NOP          NOX MODE
 3  NOP  SET BACKGROUND
 4  NOP  CAL TO LO SPAN
 5  NOP          NONE
                                     ↓
RANGE  AVG  DIAGS  ALARM
    
```

Logic State

The Logic State menu item is used to change the selected I/O relay to either normally open or normally closed. The default state is open, which indicates that a relay connected between the digital input pin and ground is normally open and closes to trigger the digital input action.

- Press  to toggle and set the logic state to normally open or normally closed.

```

DIGITAL INPUT SETUP:
>LOGIC STATE          OPEN
INSTRUMENT STATE
RANGE  AVG  DIAGS  ALARM
    
```

Instrument Action

The Instrument Action submenu allows the user to choose the instrument action that is assigned to the selected digital input. The zero and span modes are only present if the zero/span valve option is installed.

- In the Main Menu, choose Instrument Controls > I/O Configuration > Digital Input Settings > select Relay > **Instrument Action**.

```
CHOOSE ACTION:  
>NONE  
ZERO MODE  
SPAN MODE  
NO MODE  
NOX MODE  
RANGE  AVG  DIAGS  ALARM
```

```
SET BACKGROUND  
CAL TO LO SPAN  
AOUTS TO ZERO  
AOUTS TO FS  
CAL TO HI SPAN  
EXT ALARM 1  
EXT ALARM 2  
EXT ALARM 3
```

Analog Output Configuration (Select Channel)

The Analog Output Configuration menu displays a list of the analog output channels available for configuration. Channel choices include all voltage channels, all current channels, individual voltage channels 1–6, and individual current channels 1–6 (if the I/O expansion board option is installed).

- In the Main Menu, choose Instrument Controls > I/O Configuration > **Analog Output Config**.

```
OUTPUT CHANNELS:  
>ALLOW OVER/UNDER RANGE  
ALL VOLTAGE CHANNELS  
ALL CURRENT CHANNELS  
VOLTAGE CHANNEL 1  
VOLTAGE CHANNEL 2  
RANGE  AVG  DIAGS  ALARM
```

Allow Over/Under Range

The Allow Over/Under Range screen is used to select whether or not the analog outputs are allowed to exceed the maximum selected value of 100 mV, 1 V, 5 V, 10 V, or 20 mA or the minimum selected value of 0 V, 0

mA, or 4 mA. By default, this parameter is set to on and 5% over and under range is allowed for all analog output channels.

- In the Main Menu, choose Instrument Controls > I/O Configuration > Analog Output Config > **Allow Over/Under Range**.

```

ALLOW OVER/UNDER RANGE:
CURRENTLY:                ON
SET TO:                   OFF ?
                            ← TOGGLE VALUE

RANGE  AVG  DIAGS  ALARM
  
```

Analog Output Configuration (Select Action)

The Analog Output Configuration menu displays a list of the analog output configuration choices, from which the user selects the parameter to adjust for the selected output channel. Configuration choices include selecting range, setting minimum/maximum values, and choosing the signal to output.

Note The settings are different depending on the AUTO/MANUAL MODE and RANGE MODE settings. Changing either of these settings will produce a different set of analog output data items. If either of these modes is going to be changed on a regular basis, then the user must configure each set of data separately after changing the modes to each setting. ▲

- In the Main Menu, choose Instrument Controls > I/O Configuration > Analog Output Config > **All Voltage Channels, All Current Channels, Voltage Channel 1–6** or **Current Channel 1–6**.

```

ANALOG OUTPUT CONFIG:
>SELECT RANGE
SET MINIMUM VALUE
SET MAXIMUM VALUE
CHOOSE SIGNAL TO OUTPUT

RANGE  AVG  DIAGS  ALARM
  
```

Select Range

The Select Range screen is used to select the hardware range for the selected analog output channel. Possible ranges for the voltage outputs are: 0-100 mV, 0-1, 0-5, and 0-10 V. Possible ranges for the current outputs are: 0-20 mA and 4-20 mA.

- In the Main Menu, choose Instrument Controls > I/O Configuration > Analog Output Config > select Channel > **Select Range**.

```

SELECT OUTPUT RANGE:
SELECTED OUTPUT:    V ALL
CURRENTLY:          0-10V
SET TO:              0-100mV ?

↑↓ CHANGE VALUE    ← SAVE

RANGE  AVG  DIAGS  ALARM
  
```

Minimum and Maximum Value

The Minimum and Maximum Value screens are used to edit the zero (0) and full-scale (100) values, respectively, in percentages for the selected analog output channel. See Table 3-7 for a list of choices. The minimum and maximum output value screens function the same way. The following example shows the set minimum value screen.

- In the Main Menu, choose Instrument Controls > IO Configuration > Analog Output Config > select Channel > **Set Minimum** or **Maximum Value**.

```

MINIMUM OUTPUT PERCENT:
SELECTED OUTPUT:    V ALL
CURRENTLY:          N/A %
SET TO:              0000.0 % ?

↑↓ CHANGE VALUE    ← SAVE

RANGE  AVG  DIAGS  ALARM
  
```

Table 3-7. Analog Output Zero to Full-Scale Table

Output	Zero % Value	Full-Scale 100% Value
NO	Zero (0)	Range Setting
NO ₂	Zero (0)	Range Setting
NO _x	Zero (0)	Range Setting
LO NO	Zero (0)	Range Setting
LO NO ₂	Zero (0)	Range Setting
LO NO _x	Zero (0)	Range Setting
HI NO	Zero (0)	Range Setting
HI NO ₂	Zero (0)	Range Setting
HI NO _x	Zero (0)	Range Setting

Output	Zero % Value	Full-Scale 100% Value
Range (NO _x)	Recommend not to change the setting for this output	
Internal Temp	User-set alarm min value	User-set alarm max value
Chamber Temp	User-set alarm min value	User-set alarm max value
Cooler Temp	User-set alarm min value	User-set alarm max value
NO ₂ Converter Temp	User-set alarm min value	User-set alarm max value
Perm Oven Gas Temp	Perm Oven Gas alarm min value	Perm Oven Gas alarm max value
Perm Oven Heater Temp	Perm Oven Heater alarm min value	Perm Oven Heater alarm max value
Chamber Pressure	User-set alarm min value	User-set alarm max value
Flow	User-set alarm min value	User-set alarm max value
PMT Volts	700 volts	1100 volts
Ozonator Flow	User-set alarm min value	User-set alarm max value
Everything Else	0 Units	10 Units

Choose Signal to Output

The Choose Signal to Output screen displays a list of the analog output signal choices. Choices are grouped into three categories: Concentrations, Other Measurements, and Analog Inputs (if the I/O expansion board option is installed). This allows the user to select the output signal that will be assigned to each analog channel. The Concentrations screen is shown below. See [Table 3–8](#) for a list of items for each signal group choice. The analog inputs 1–8 will not show if the Ouput Conc Cal option is set to YES in the Instrument Configuration screen.

Note The settings are different depending on the AUTO/MANUAL MODE and RANGE MODE settings. Changing either of these settings will produce a different set of analog output data items. If either of these modes is going to be changed on a regular basis, then the user must configure each set of data separately after changing the modes to each setting. ▲

- In the Main Menu, choose Instrument Controls > I/O Configuration > Analog Output Config > select Channel > **Choose Signal to Output**.

Operation

Instrument Controls Menu

```

CHOOSE SIGNAL TYPE:
>CONCENTRATIONS
  OTHER MEASUREMENTS
  ANALOG INPUTS

RANGE  AVG  DIAGS  ALARM
  
```

```

CHOOSE SIGNAL -      CONC
SELECTED OUTPUT:    V1
CURRENTLY: NO
SET TO: NONE        ?

↑↓ CHANGE VALUE    ← SAVE

RANGE  AVG  DIAGS  ALARM
  
```

Table 3–8. Signal Type Group Choices

Concentrations	Other Measurements	Analog Inputs
None	None	None
NO (single/auto range mode)	Internal Temp	Analog Input 1
NO ₂ (single/auto range mode)	Chamber Temp	Analog Input 2
NO _x (single/auto range mode)	Cooler Temp	Analog Input 3
LO NO (dual mode)	NO ₂ Converter Temp	Analog Input 4
LO NO ₂ dual mode)	Perm Oven Gas	Analog Input 5
LO NO _x (dual mode)	Perm Oven Heater	Analog Input 6
HI NO (dual mode)	Chamber Pressure	Analog Input 7
HI NO ₂ (dual mode)	Flow	Analog Input 8
HI NO _x dual mode)	PMT Volts	
Range (NO _x) (auto range mode)	NO BKG	
	NO _x BKG	
	LO NO COEF	
	LO NO ₂ COEF	
	LO NO _x COEF	
	HI NO COEF	
	HI NO ₂ COEF	
	HI NO _x COEF	
	Ozonator Flow	
	Ext Alarms	

Analog Input Configuration

The Analog Input Configuration menu displays a list of the 8 analog input channels available for configuration. This screen is only displayed if the I/O expansion board option is installed. Configuration includes entering the Descriptor, Units, Decimal Places, choice of 1–10 points in the table, and corresponding number of points selected. This menu is not displayed if the Output Conc Cal option is selected.

- In the Main Menu, choose Instrument Controls > I/O Configuration > **Analog Input Config.**

```

ANALOG INPUT CONFIG:
>CHANNEL 1          IN1
CHANNEL 2          IN2
CHANNEL 3          IN3
CHANNEL 4          IN4
CHANNEL 5          IN5↓
RANGE  AVG  DIAGS  ALARM
  
```

```

ANALOG INPUT 01 CONFIG:
>DESCRIPTOR          IN1
UNITS                V
DECIMAL PLACES      2
TABLE POINTS        2
POINT 1
RANGE  AVG  DIAGS  ALARM
  
```

POINT 2

Descriptor

The Descriptor screen allows the user to enter the descriptor, or name, for the selected analog input channel. The descriptor is used in datalogging and streaming data to report what data is being sent out. The descriptor may be from 1 to 3 characters in length, and defaults to IN1 to IN8 (user input channel number).

- In the Main Menu, choose Instrument Controls > I/O Configuration > Analog Input Config > select Channel > **Descriptor.**

```

ANALOG INPUT DESCRIPTOR:
CURRENTLY: IN1
          IN1
          ABCDEFGHIJKLMN  BKSP
          OPQRSTUVWXYZ   PAGE
          0123456789 . / -  SAVE
RANGE  AVG  DIAGS  ALARM
  
```

Units The Units screen allows the user to enter the units for the selected analog input channel. The units are displayed on the diagnostic screen and in datalogging and streaming data. The units may be from 1 to 3 characters in length, and defaults to V (volts).

- In the Main Menu, choose Instrument Controls > I/O Configuration > Analog Input Config > select Channel > **Units**.

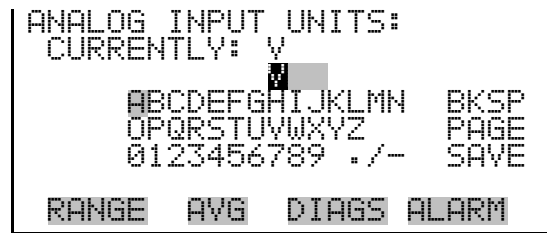

Decimal Places The Decimal Places screen allows the user to select how many digits are displayed to the right of the decimal, from 0 to 6, with a default of 2.

- In the Main Menu, choose Instrument Controls > I/O Configuration > Analog Input Config > Select Channel > **Decimal Places**.



Number of Table Points The Number of Table Points screen allows the user to select how many points are used in the analog input conversion table for the selected channel. The instrument uses linear interpolation between the points in this table to determine what the reading value is based on the analog input voltage. Each point in the table consists of an analog input voltage value (0–10.5 V) and a corresponding reading value. Only two points are necessary for linear inputs, however a larger number of points may be used to approximate non-linear inputs. The points range from 2 to 10, with a default of 2.

- In the Main Menu, choose Instrument Controls > I/O Configuration > Analog Input Config > select Channel > **Table Points**.

```

NUMBER OF TABLE POINTS:
CURRENTLY:                2
SET TO:                    10 ?

      ↑↓ CHANGE VALUE
      ← SAVE VALUE

RANGE  AVG  DIAGS  ALARM
  
```

Table Point The Table Point submenu allows the user to set up an individual table point.

- In the Main Menu, choose Instrument Controls > I/O Configuration > Analog Input Config > Select Channel > **Point 1-10**.

```

TABLE POINT 01 CONFIG:
>VOLTS                0.00
USER VALUE            0.00

RANGE  AVG  DIAGS  ALARM
  
```

Volts The Volts screen allows the user to set the input voltage for the selected table point in the conversion table, from 0.00 to 10.50. The default table is a two-point table with point 1: 0.00 V = 000.0 U and point 2: 10.00 V = 10.0 U, where U is the previously entered unit of measure.

- In the Main Menu, choose Instrument Controls > I/O Configuration > Analog Input Config > select Channel > select Point > **Volts**.

```

TABLE POINT 01 VOLTS:
CURRENTLY:                0.00
SET TO:                    00.00

      ↔ MOVE CURSOR
      ↑↓ CHANGE VALUE  ← SAVE

RANGE  AVG  DIAGS  ALARM
  
```

User Value

The User Value screen allows the user to set the output value for the corresponding input voltage for the selected table point in the conversion table, from -9999999 to 99999999. The default table is a two-point table with point 1: 0.00 V = 000.0 U and point 2: 10.00 V = 10.0 U, where U is the previously entered unit of measure.

- In the Main Menu, choose Instrument Controls > I/O Configuration > Analog Input Config > select Channel > select Point > **User Value**.

```
TABLE POINT 01 USER VAL:
CURRENTLY:          0.00
SET TO:             00000.00

      ←→ MOVE CURSOR
↑↓ CHANGE VALUE    ← SAVE

RANGE  AVG  DIAGS  ALARM
```

Temperature Compensation

The Temperature Compensation screen allows the user to turn temperature compensation on or off. Temperature compensation changes to the instrument's output signal that occur due to internal instrument temperature variations. The effects of temperature changes on the analyzer's subsystems and output have been empirically determined. This empirical data is used to compensate for any changes in temperature. This compensation can be used for special applications, or when operating the instrument outside the recommended temperature range, even though the Model 42i does not require temperature compensation for EPA equivalency.

When temperature compensation is on, the display shows the current internal instrument temperature (measured by a thermistor on the Interface board). When temperature compensation is off, the display shows the factory standard temperature of 30 °C.

- In the Main Menu, choose Instrument Controls > **Temperature Compensation**.

```
TEMPERATURE COMPENSATION:
COMP TEMP:          30.0 °C
CURRENTLY:          OFF
SET TO:             ON ?

      ← TOGGLE VALUE

RANGE  AVG  DIAGS  ALARM
```

Pressure Compensation

Pressure compensation provides compensation for any changes to the instrument's output signal due to reaction chamber pressure variations. The effects of reaction chamber pressure changes on the analyzer's subsystems and output have been empirically determined. This empirical data is used to compensate for any change in reaction chamber pressure. This compensation can be used even though the Model 42*i* does not require pressure compensation for EPA equivalency.

When pressure compensation is on, the first line of the display represents the current pressure in the reaction chamber. When pressure compensation is off, the first line of the display shows the factory standard pressure of 200 mmHg.

- In the Main Menu, choose Instrument Controls > **Pressure Compensation**.

```

PRESSURE COMPENSATION:
COMP PRES:    200.0 mmHg
CURRENTLY:    OFF
SET TO:       ON ?

      ← TOGGLE VALUE

RANGE  AVG  DIAGS  ALARM
  
```

Screen Contrast

The Screen Contrast screen is used to change the contrast of the display. Intensities between 0 and 100% in increments of 5 are available. Changing the screen contrast may be necessary if the instrument is operated at extreme temperatures.

Note The optimal contrast will change with changes in temperature. ▲

Note The optimal contrast will change from one LCD to another. If the LCD is replaced, the contrast may need to be reset. ▲

Note If the display contrast is not optimal, but the content on the screen is visible, select Instrument Controls > **Screen Contrast** and adjust the screen contrast. If the content on the screen is not visible, use the “set contrast 10” C-Link command to set the screen contrast to mid-range, then optimize the contrast. See “contrast levels” in Appendix B, “[C-Link Protocol Commands](#)” for more information on this command. ▲

- In the Main Menu, choose Instrument Controls > **Screen Contrast**.

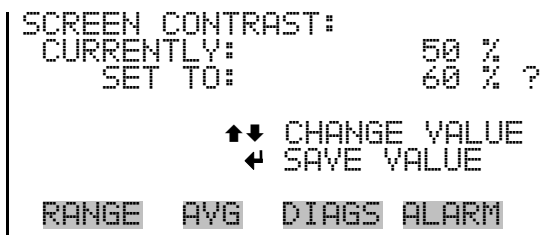

Service Mode

The Service Mode screen is used to turn the service mode on or off. Turning service mode “ON” locks out any remote actions and allows access to parameters and functions that are useful when making adjustments or diagnosing the Model 15*i*. The service (wrench) icon on the status bar is shown when service mode is on. For more information about the service mode, see “[Service Menu](#)” later in this chapter.

Note The service mode should be turned off when finished, as it prevents remote operation. ▲

- In the Main Menu, choose Instrument Controls > **Service Mode**.



Date/Time

The Date/Time screen allows the user to view and change the system date and time (24-hour format). The internal clock is powered by its own battery when instrument power is off.

- In the Main Menu, choose Instrument Controls > **Date/Time**.

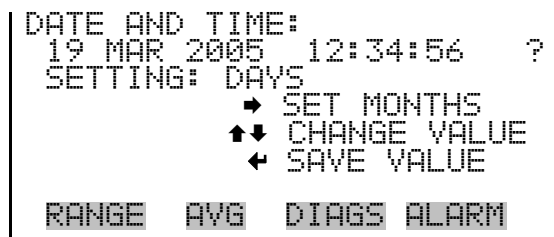
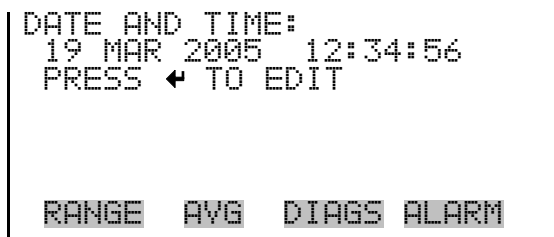

Timezone

The Timezone screen is used to set the timezone for the Network Time Protocol (NTP) server. This should be set to the timezone that the instrument is located in. If the exact timezone is not shown in the list, it may be entered via the C-LINK “tz” command (see Appendix B). The selections are: UTC (GMT), EST (GMT+5), CST (GMT+6), MST (GMT+7), PST (GMT+8), YST (GMT+9), HST (GMT+10), NST (GMT+11), DLW (GMT+12), CET (GMT-1), EET (GMT-2), BST (GMT-3), DLT (GMT-4), ECH (GMT-5), FOX (GMT-6), GLF (GMT-7), CCT (GMT-8), JST (GMT-9), GST (GMT-10), LMA (GMT-11), DLE (GMT-12), EDT (GMT+5/4), CDT (GMT+6/5), MDT (GMT+7/6), and PDT (GMT+8/7).

Note The current timezone may say NULL before the timezone is set for the first time, or if the timezone was cleared with a C-Link command. ▲

- In the Main Menu, choose Instrument Controls > **Timezone**.

```

TIMEZONE FOR TIMESERVER:
CURRENTLY: UTC (GMT)
SET TO: EST (GMT+5) ?

      ↑↓ CHANGE VALUE
      ← SAVE VALUE

RANGE  AVG  DIAGS  ALARM
  
```

Diagnostics Menu

The Diagnostics menu provides access to diagnostic information and functions. This menu is useful when troubleshooting the instrument. The analog input readings and analog input voltages are only displayed if the I/O expansion board option is installed.

- In the Main Menu, choose **Diagnostics**.

```
DIAGNOSTICS:  
>PROGRAM VERSION  
VOLTAGES  
TEMPERATURES  
PRESSURE  
FLOW  
↓  
RANGE  AVG  DIAGS  ALARM  
  
ANALOG INPUT READINGS  
ANALOG INPUT VOLTAGES  
DIGITAL INPUTS  
RELAY STATES  
TEST ANALOG OUTPUTS  
INSTRUMENT CONFIGURATION  
CONTACT INFORMATION
```

Program Version

The Program Version screen (read only) shows the version number of the program installed. Prior to contacting the factory with any questions regarding the instrument, please note the product model name and program version number.

- In the Main Menu, choose Diagnostics > **Program Version**.

```
PROGRAM VERSIONS:  
PRODUCT:  MODEL 42i  
VERSION:  01.00.01.074  
FIRMWARE: 09.06.19  
  
RANGE  AVG  DIAGS  ALARM
```

Voltages

The Voltages menu displays the current diagnostic voltage readings. This screen enables the power supply to be quickly read for low or fluctuating voltages without having to use a voltage meter. The I/O board item is only displayed if the I/O expansion board option is installed.

- In the Main Menu, choose Diagnostics > **Voltages**.

```
VOLTAGES:  
>MOTHERBOARD  
INTERFACE BOARD  
I/O BOARD  
  
RANGE  AVG  DIAGS  ALARM
```

Motherboard Voltages

The Motherboard screen (read only) is used to display the current voltage readings on the motherboard.

- In the Main Menu, choose Diagnostics > Voltages > **Motherboard Voltages**.

```

MOTHERBOARD VOLTAGES:
 3.3 SUPPLY          3.3 V
 5.0 SUPPLY          5.0 V
24.0 SUPPLY         24.1 V
-3.3 SUPPLY         -3.3 V

RANGE  AVG  DIAGS  ALARM
  
```

Interface Board Voltages

The Interface Board screen (read only) is used to display the current voltage readings on the interface board.

- In the Main Menu, choose Diagnostics > Voltages > **Interface Board Voltages**.

```

INTERFACE BOARD VOLTAGES:
FMT SUPPLY          785.5 V
 3.3 SUPPLY          3.3 V
 5.0 SUPPLY          5.0 V
15.0 SUPPLY         15.0 V
P15.0 SUPPLY        15.0 V↓

RANGE  AVG  DIAGS  ALARM

24.0 SUPPLY          24.0 V
-15.0 SUPPLY         -15.0 V
  
```

I/O Board Voltages

The I/O Board screen (read only) is used to display the current voltage readings on the I/O expansion board. This menu is only displayed if the I/O expansion board option is installed.

- In the Main Menu, choose Diagnostics > Voltages > **I/O Board Voltages**.

```
I/O BOARD VOLTAGES:
 3.3 SUPPLY      3.3 V
 5.0 SUPPLY      5.0 V
15.0 SUPPLY      5.0 V
24.0 SUPPLY     24.0 V
-3.3 SUPPLY     -3.3 V

RANGE  AVG  DIAGS  ALARM
```

Temperatures

The Temperatures screen (read only) displays the internal temperature, reaction chamber temperature, cooler temperature, converter temperatures, and perm oven temperatures (if the permeation oven option is installed). The internal temperature is the air temperature measured by a sensor located on the interface board.

- In the Main Menu, choose Diagnostics > **Temperatures**.

```
TEMPERATURES:
INTERNAL          28.6 °C
CHAMBER          49.0 °C
COOLER          -10.0 °C
NO2 CONVERTER    320.7 °C
NO2 CONV SET     325.0 °C ↓

RANGE  AVG  DIAGS  ALARM

PERM OVEN GAS    45.0 °C
PERM OVEN HEATER 45.0 °C
```

Pressure

The Pressure screen (read only) displays the reaction chamber pressure. The pressure is measured by a pressure transducer at the reaction chamber.

- In the Main Menu, choose Diagnostics > **Pressure**.

```
PRESSURE:          232.5 mmHg

RANGE  AVG  DIAGS  ALARM
```

Flow

The Flow screen (read only) displays the sample and ozonator flow rate. The flows are measured by internal flow sensors. For more information, see [Figure 1-1](#).

- In the Main Menu, choose Diagnostics > **Flow**.

```

FLOW:                0.700 LPM
OZONATOR FLOW        OK

RANGE  AVG  DIAGS  ALARM
  
```

Analog Input Readings

The Analog Input Readings screen (read only) displays the 8 user-scaled analog readings (if the I/O expansion board option is installed).

- In the Main Menu, choose Diagnostics > **Analog Input Readings**.

```

ANALOG INPUT READINGS:
>CO                10.2 PPM
SO2                18.2 PPB
CO2                250 PPM
FL1                20.42 LPM
ID7                0.0 V↓

RANGE  AVG  DIAGS  ALARM
  
```

Analog Input Voltages

The Analog Input Voltages screen (read only) displays the 8 raw analog voltage readings (if the I/O expansion board option is installed).

- In the Main Menu, choose Diagnostics > **Analog Input Voltages**.

```

ANALOG INPUT VOLTAGES:
>ANALOG IN 1        6.24 V
ANALOG IN 2        4.28 V
ANALOG IN 3        0.00 V
ANALOG IN 4        0.00 V
ANALOG IN 5        0.00 V↓

RANGE  AVG  DIAGS  ALARM
  
```

Digital Inputs

The Digital Inputs screen (read only) displays the state of the 16 digital inputs. Pull-ups are provided on all of the inputs, so if nothing is connected they will read (1), if an input is brought to ground, it will read (0).

- In the Main Menu, choose Diagnostics > **Digital Inputs**.

```
DIGITAL INPUTS:
>INPUT 1          1
INPUT 2          1
INPUT 3          1
INPUT 4          1
INPUT 5          1↓
RANGE  AVG  DIAGS  ALARM
```

Relay States

The Relay States screen displays the state of the 10 digital outputs and allows toggling of the state to either on (1) or off (0). The relays are restored to their original states upon exiting this screen.

- In the Main Menu, choose Diagnostics > **Relay States**.
- Press  to toggle and set the relay state to open or closed for the selected digital output.

```
RELAY STATE:
>OUTPUT 1        0
OUTPUT 2        0
OUTPUT 3        0
OUTPUT 4        1
OUTPUT 5        1↓
RANGE  AVG  DIAGS  ALARM
```

Test Analog Outputs

The Test Analog Outputs menu is used to set each of the analog output channels to zero or full-scale. Channel choices include all analog outputs, 6 voltage channels, and 6 current channels (if the I/O expansion board option is installed).

- In the Main Menu, choose Diagnostics > **Test Analog Outputs**.

```
TEST ANALOG OUTPUTS:
>ALL
VOLTAGE CHANNEL 1
VOLTAGE CHANNEL 2
VOLTAGE CHANNEL 3
VOLTAGE CHANNEL 4
RANGE  AVG  DIAGS  ALARM
```

Set Analog Outputs

The Set Analog Outputs screen contains three choices: Set to full-scale, set to zero, or reset to normal. Full-scale sets the analog outputs to the full-scale voltage, zero sets the analog outputs to 0 volts, and reset returns the output to normal operation. The analog outputs are returned to normal

operation upon exiting this screen. The following example shows the screen when all analog outputs are set to “normal” operating mode.

- In the Main Menu, choose Diagnostics > Test Analog Outputs > **ALL, Voltage Channel 1–6, or Current Channel 1–6.**

```

SET ANALOG OUTPUTS:
SETTING:                ALL
OUTPUT SET TO:         NORMAL
↑ SET TO FULL SCALE
↓ SET TO ZERO
← RESET TO NORMAL

RANGE  AVG  DIAGS  ALARM
  
```

Instrument Configuration

The Instrument Configuration screen displays information on the hardware configuration of the instrument.

Note If the analyzer is in service mode, pressing  will toggle the selected item between yes and no. Zero/span valves needs to be set to ON in order to do zero and span checks, and auto calibration needs to be set to ON in order to do zero and span calibration resets. ▲

- In the Main Menu, choose Diagnostics > **Instrument Configuration.**

```

INSTRUMENT CONFIGURATION:
> I/O EXPANSION BOARD  YES
ZERO/SPAN VALVES      YES
PERM OVEN              YES
LAG VOLUME             NO
PERM DRYER             NO ↓

RANGE  AVG  DIAGS  ALARM

CONVERTER              MOLY
DILUTION               NO
AUTO CALIBRATION      NO
OUTPUT CONC CAL DATA NO
  
```

Contact Information

The Contact Information screen displays the customer service information.

- In the Main Menu, choose Diagnostics > **Contact Information.**

```
CONTACT INFORMATION:
CALL CENTER: 508-520-0430
WEB: WWW.THERMO.COM
RANGE  AVG  DIAGS  ALARM
```

Alarms Menu

The Alarms menu displays a list of items that are monitored by the analyzer. If the item being monitored goes outside the lower or upper limit, the status of that item will go from “OK” to either “LOW” or “HIGH”, respectively. If the alarm is not a level alarm, the status will go from “OK” to “FAIL”. The total number of alarms detected is displayed to indicate how many alarms have occurred.

To see the actual reading of an item and its minimum and maximum limits, move the cursor to the item and press .

Items displayed are determined by the options installed. The zero/span check and auto calibration screens are visible only if the zero/span check or auto calibration options are enabled. The perm oven temperature screen is visible only if the perm oven option is installed. The External Alarms menu is displayed only if assigned as a digital input. The motherboard status, interface board status, and I/O Expansion board status (if installed) indicate that the power supplies are working and connections are successful. There are no setting screens for these alarms.

- In the Main Menu, choose **Alarms**.

```
ALARMS:
ALARMS DETECTED          0
>INTERNAL TEMP           OK
CHAMBER TEMP             OK
COOLER TEMP             OK
CONVERTER TEMP          OK↓
RANGE  AVG  DIAGS  ALARM
```

```
PERM GAS TEMP           OK
PRESSURE                OK
FLOW                   OK
OZONATOR FLOW           OK
ZERO CHECK              OK
SPAN CHECK              OK
ZERO AUTOCAL            OK
SPAN AUTOCAL            OK
NO CONCENTRATION        OK
NO2 CONCENTRATION       OK
NOX CONCENTRATION       OK
EXTERANL ALARMS         OK
MOTHERBOARD STATUS      OK
INTERFACE STATUS         OK
I/O EXP STATUS           OK
```

Internal Temperature

The Internal Temperature screen displays the current internal temperature and sets the minimum and maximum alarm limits. Acceptable alarm limits range from 8 to 47 °C. If the internal temperature reading goes beyond either the minimum or maximum limit, an alarm is activated and the alarm (bell) icon appears in the status bar on the Run screen and in the Main Menu.

- In the Main Menu, choose Alarms > **Internal Temp.**

```

INTERNAL TEMPERATURE:
ACTUAL                28.6 °C
>MIN                  15.0 °C
MAX                   45.0 °C

RANGE  AVG  DIAGS  ALARM
  
```

Min and Max Internal Temperature Limits

The Minimum Internal Temperature alarm limit screen is used to change the minimum internal temperature alarm limit. The minimum and maximum internal temperature screens function the same way.

- In the Main Menu, choose Alarms > Internal Temp > **Min** or **Max**.

```

INTERNAL TEMPERATURE:
ACTUAL MIN:           15.0 °C
SET MIN TO:           16.0 °C ?

      ↑↓ INC/DEC
      ← SAVE VALUE

RANGE  AVG  DIAGS  ALARM
  
```

Chamber Temperature

The Chamber Temperature screen displays the current chamber temperature and sets the minimum and maximum alarm limits. Acceptable alarm limits range from 48 to 52 °C. If the chamber temperature reading goes beyond either the minimum or maximum limit, an alarm is activated and the alarm (bell) icon appears in the status bar on the Run screen and in the Main Menu.

- In the Main Menu, choose Alarms > **Chamber Temp.**

```
CHAMBER TEMPERATURE:
ACTUAL                49.0 °C
>MIN                 48.0 °C
MAX                  52.0 °C

RANGE  AVG  DIAGS  ALARM
```

Min and Max Chamber Temperature Limits

The Minimum Chamber Temperature alarm limit screen is used to change the minimum chamber temperature alarm limit. The minimum and maximum chamber temperature screens function the same way.

- In the Main Menu, choose Alarms > Chamber Temp > **Min** or **Max**.

```
CHAMBER TEMPERATURE:
ACTUAL MIN:          48.0 °C
SET MIN TO:         49.0 °C ?

  ↑↓ INC/DEC
  ← SAVE VALUE

RANGE  AVG  DIAGS  ALARM
```

Cooler Temperature

The Cooler Temperature screen displays the current cooler temperature and sets the minimum and maximum alarm limits. Acceptable alarm limits range from -40 to 10 °C. If the cooler temperature reading goes beyond either the minimum or maximum limit, an alarm is activated and the alarm (bell) icon appears in the status bar on the Run screen and in the Main Menu.

- In the Main Menu, choose Alarms > **Cooler Temp**.

```
COOLER TEMPERATURE:
ACTUAL                -9.8 °C
>MIN                 -20.0 °C
MAX                   -1.0 °C

RANGE  AVG  DIAGS  ALARM
```

Min and Max Cooler Temperature Limits

The Minimum Cooler Temperature alarm limit screen is used to change the minimum cooler temperature alarm limit. The minimum and maximum cooler temperature screens function the same way.

- In the Main Menu, choose Alarms > Cooler Temp > **Min** or **Max**.

```

COOLER TEMPERATURE:
ACTUAL MIN          -20.0 °C
SET MIN TO:        -10.0 °C ?

      ↑↓ INC/DEC
      ← SAVE VALUE

RANGE  AVG  DIAGS  ALARM
  
```

Converter Temperature

The Converter Temperature screen displays the current converter temperature and sets the minimum and maximum alarm limits. Acceptable alarm limits range from 300 to 700 °C. The actual alarm setpoints should be set for the installed converter. If the converter temperature reading goes beyond either the minimum or maximum limit, an alarm is activated and the alarm (bell) icon appears in the status bar on the Run screen and in the Main Menu.

- In the Main Menu, choose Alarms > **Converter Temp**.

```

CONVERTER TEMPERATURE:
ACTUAL          320.7 °C
>MIN           300.0 °C
MAX            350.0 °C

RANGE  AVG  DIAGS  ALARM
  
```

Min and Max Converter Temperature Limits

The Minimum Converter Temperature alarm limit screen is used to change the minimum converter temperature alarm limit. The minimum and maximum converter temperature screens function the same way.

- In the Main Menu, choose Alarms > Converter Temp > **Min** or **Max**.

```

CONVERTER TEMPERATURE:
ACTUAL MIN          300.0 °C
SET MIN TO:        310.0 °C ?

      ↑↓ INC/DEC
      ← SAVE VALUE

RANGE  AVG  DIAGS  ALARM
  
```

Permeation Oven Gas Temperature

The Permeation Oven Gas Temperature screen displays the current permeation oven gas temperature and sets the minimum and maximum alarm limits. Acceptable alarm limits range from 25.00 to 50.00 °C. If the

temperature reading goes beyond either the minimum or maximum limit, an alarm is activated and the alarm (bell) icon appears in the status bar on the Run screen and in the Main Menu.

- In the Main Menu, choose Alarms > **Perm Gas Temp**.

```
POVEN GAS TEMPERATURE:
  ACTUAL                45.00 °C
 >MIN                   44.90 °C
  MAX                   45.10 °C

RANGE  AVG  DIAGS  ALARM
```

Min and Max Permeation Oven Temperature Limits

The Minimum Permeation Oven Gas Temperature alarm limit screen is used to change the minimum temperature alarm limit. The minimum and maximum permeation gas temperature screens function the same way.

- In the Main Menu, choose Alarms > Perm Gas Temp > **Min** or **Max**.

```
POVEN GAS TEMPERATURE:
  ACTUAL MIN            300.0 °C
  SET MIN TO:          310.0 °C ?

      ↑↓ INC/DEC
      ← SAVE VALUE

RANGE  AVG  DIAGS  ALARM
```

Pressure

The Pressure screen displays the current reaction chamber pressure reading and sets the minimum and maximum alarm limits. Acceptable alarm limits range from 150 to 300 mmHg. If the pressure reading goes beyond either the minimum or maximum limit, an alarm is activated and the alarm (bell) icon appears in the status bar on the Run screen and in the Main Menu.

- In the Main Menu, choose Alarms > **Pressure**.

```
PRESSURE:
  ACTUAL                232.5 mmHg
 >MIN                   150.0 mmHg
  MAX                   300.0 mmHg

RANGE  AVG  DIAGS  ALARM
```

Min and Max Pressure Limits

The Minimum Pressure alarm limit screen is used to change the minimum temperature alarm limit. The minimum and maximum pressure screens function the same way.

- In the Main Menu, choose Alarms > Pressure > **Min** or **Max**.

```

PRESSURE:
ACTUAL MIN:    200.0 mmHg
SET MIN TO:   210.0 mmHg?

      ↑↓ INC/DEC
      ← SAVE VALUE

RANGE  AVG  DIAGS  ALARM
  
```

Flow

The Flow screen displays the current sample flow reading and sets the minimum and maximum alarm limits. Acceptable alarm limits range from 0 to 1 LPM. If the sample flow reading goes beyond either the minimum or maximum limit, an alarm is activated and the alarm (bell) icon appears in the status bar on the Run screen and in the Main Menu.

- In the Main Menu, choose Alarms > **Flow**.

```

FLOW:
ACTUAL          0.531 LPM
>MIN           0.750 LPM
MAX            1.000 LPM

RANGE  AVG  DIAGS  ALARM
  
```

Min and Max Flow Limits

The Minimum Flow alarm limit screen is used to change the minimum sample flow alarm limit. The minimum and maximum flow screens function the same way.

- In the Main Menu, choose Alarms > Flow > **Min** or **Max**.

```

FLOW:
ACTUAL MIN:    0.750 LPM
SET MIN TO:   0.760 LPM ?

      ↑↓ INC/DEC
      ← SAVE VALUE

RANGE  AVG  DIAGS  ALARM
  
```

Ozonator Flow

The Ozonator Flow screen (read only) is used to display the ozonator flow readings. If the ozonator flow reading is 0.050 LPM (50 cc) or below, an alarm is activated, and an alarm condition screen appears as “LOW”. If the ozonator flow is above 0.050, the no alarm condition screen is displayed, indicating that the flow is acceptable. Inadequate ozonator flow will cause the ozonator to overheat, resulting in permanent damage to the ozonator.

- In the Main Menu, choose Alarms > **Ozonator Flow**.

```
OZONATOR FLOW:
ACTUAL          > 0.050 LPM

RANGE  AVG  DIAGS  ALARM
```

Zero and Span Check

The Zero and Span Check screens allow the user to view the status of the most recent zero/span checks and set the maximum check offsets. An alarm will be triggered if a zero or span check indicates drift that exceeds the offset value. The zero and span check screens are visible only if the zero/span check option is enabled and function the same way.

- In the Main Menu, choose Alarms > **Zero** or **Span Check**.

```
ZERO CHECK:
ALARM:      OK
RESPONSE:   0.000
>MAX OFFSET: 10.000

RANGE  AVG  DIAGS  ALARM
```

Max Zero and Span Check Offset

The Max Zero and Span Check Offset screens are used to change the maximum check offsets. The maximum zero and span offset screens function the same way.

- In the Main Menu, choose Alarms > Zero or Span Check > **Max Offset**.

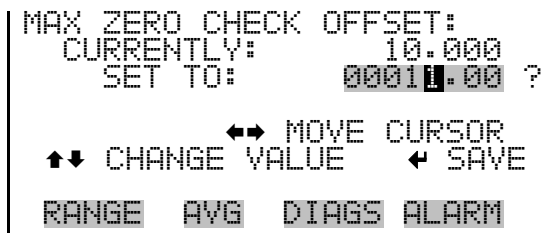

Zero and Span Auto Calibration

The Zero and Span Auto Calibration screens (read only) allow the user to view the status of the most recent auto background calibration or span calibrations. The zero and span auto calibration screens are visible only if the auto calibration option is enabled and the zero or span cal reset function is enabled.

- In the Main Menu, choose Alarms > **Zero** or **Span Autocal**.

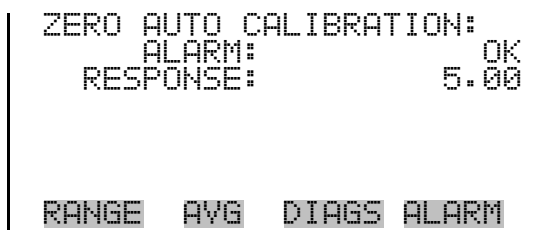

NO, NO₂, and NO_x Concentration

The NO Concentration screen displays the current NO concentration and sets the minimum and maximum alarm limits. Acceptable alarm limits range from 0 to 100,000 ppb (0 to 100 ppm) and 0 to 150,000 $\mu\text{g}/\text{m}^3$ (0 to 150 mg/m^3). The minimum alarm may be programmed as a floor trigger (alarm is triggered when the concentration falls below the minimum value) or a ceiling trigger (alarm is triggered when the concentration goes above the minimum value). If the NO concentration goes beyond either the minimum or maximum limit, an alarm is activated and the alarm (bell) icon appears in the status bar on the Run screen and in the Main Menu. The NO₂ and NO_x concentration screens function the same way.

- In the Main Menu, choose Alarms > **NO**, **NO₂**, or **NO_x Concentration**.

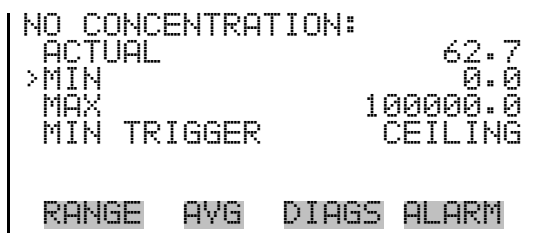

Min and Max NO, NO₂, and NO_x Concentration Limits

The Minimum NO Concentration alarm limit screen is used to change the minimum NO concentration alarm limits. The minimum and maximum NO, NO₂, and NO_x concentration alarm limit screens function the same way.

- In the Main Menu, choose Alarms > Select Concentration > **Min** or **Max**.

```
NO CONCENTRATION:
ACTUAL MIN:      0.0
SET MIN TO:     00000.00 ?

      ←→ MOVE CURSOR
↑↓ CHANGE VALUE  ← SAVE

RANGE  AVG  DIAGS  ALARM
```

Min Trigger

The Minimum Trigger screen allows the user to keep set the minimum NO, NO₂, and NO_x concentration alarm trigger type to either floor or ceiling. The minimum alarm may be programmed as a floor trigger (alarm is triggered when the concentration falls below the minimum value) or a ceiling trigger (alarm is triggered when the concentration goes above the minimum value).

- In the Main Menu, choose Alarms > Select Concentration > **Min Trigger**.

```
MIN TRIG<CEILING/FLOOR>:
ACTUAL TRIGGER:  CEILING
SET TRIGGER TO:  FLOOR ?

      ← TOGGLE AND SAVE VALUE

RANGE  AVG  DIAGS  ALARM
```

External Alarms

The External Alarms menu is used to display the external alarm status for alarm 1, 2, and 3 only if the external alarm is assigned as a digital input. External alarms can be assigned to digital inputs using the Instruments Controls > I/O Configuration > Digital Input Settings menu. External alarms can also be logged, streamed, or output as a digital output by choosing “EXT ALARMS” from the Other Measurements list.

- In the Main Menu, choose Alarms > **External Alarms**.

```
ALARMS:
EXTERNAL ALARM 1      OK
EXTERNAL ALARM 2      OK
EXTERNAL ALARM 3      OK

RANGE  AVG  DIAGS  ALARM
```

Service Menu

The Service menu appears only when the instrument is in the service mode. When the service mode is active, the service (wrench) icon is displayed on the right side of the status bar. To put the instrument into the service mode:

- In the Main Menu, choose Instrument Controls > **Service Mode**.

Advanced diagnostic functions are included in the service mode. Meaningful data should not be collected when the instrument is in the service mode.

- In the Main Menu, choose **Service**.

```
SERVICE:
>PMT VOLTAGE ADJUSTMENT
RANGE MODE SELECT
CONVERTER SET TEMP
PRESSURE CALIBRATION
FLOW CALIBRATION      ↓

RANGE  AVG  DIAGS  ALARM
```

```
INPUT BOARD CALIBRATION
TEMPERATURE CALIBRATION
ANALOG OUT CAL
ANALOG INPUT CAL
PERM OVEN SETTINGS
OZONATOR SAFETY
EXTENDED RANGES
DILUTION RATIO
DISPLAY PIXEL TEST
RESTORE USER DEFAULTS
```

PMT Voltage Adjustment

The PMT Voltage Adjustment screen is used to manually adjust the PMT supply voltage. The PMT voltage adjustment screen is visible only when the instrument is in service mode. For more information on the service mode, see “[Service Mode](#)” earlier in this chapter.

Note This adjustment should only be performed by an instrument service technician. ▲

- In the Main Menu, choose Service > **PMT Voltage Adjustment**.

```
SET PMT VOLTAGE:
SET PMT:        -750.0 V
COUNTS:        2254 ?

      ↑↓ CHANGE VALUE
      ← SAVE VALUE

RANGE  AVG  DIAGS  ALARM
```

Range Mode Select

The Range Mode Select screen is used to switch between the various range modes: Single, Dual, and Auto Range. The range mode select screen is visible only when the instrument is in service mode. For more information on the service mode, see “[Service Mode](#)” earlier in this chapter.

- In the Main Menu, choose Service > **Range Mode Select**.

```
RANGE MODE SELECT:
CURRENTLY:      SINGLE
SET TO:        DUAL ?

      ↑↓ CHANGE VALUE
      ← SAVE VALUE

RANGE  AVG  DIAGS  ALARM
```

Converter Set Temperature

The Converter Set Temperature screen is used to change the converter set temperature. The converter set temperature reading is updated every second. The converter set temperature screen is visible only when the instrument is in service mode. For more information on the service mode, see “[Service Mode](#)” earlier in the chapter.

Note This adjustment should only be performed by an instrument service technician. ▲

- In the Main Menu, choose Service > **Converter Set Temperature**.

```
SET CONVERTER TEMP:
CURRENTLY:      325 °C
SET TO:        325 °C

      ↑↓ INC/DEC
      ← SAVE VALUE

RANGE  AVG  DIAGS  ALARM
```

Pressure Calibration

The Pressure Calibration submenu is used to calibrate the pressure sensor to zero, span, or restore factory default values. The pressure calibration is visible only when the instrument is in service mode. For more information on the service mode, see “Service Mode” earlier in this chapter.

The pressure sensor’s zero counts and span slope are displayed on the menu.

Note This adjustment should only be performed by an instrument service technician. ▲

- In the Main Menu, choose Service > **Pressure Calibration**.

```

PRESSURE SENSOR CAL:
>ZERO                72
SPAN                 1.1416
SET DEFAULTS

RANGE  AVG  DIAGS  ALARM
  
```

Calibrate Pressure Zero

The Calibrate Pressure Zero screen calibrates the pressure sensor at zero pressure.

Note A vacuum pump must be connected to the pressure sensor before performing the zero calibration. ▲

Note Wait at least 30 seconds for the reading to stabilize before saving the value. ▲

- In the Main Menu, choose Service > Pressure Calibration > **Zero**.

```

CALIBRATE PRESSURE ZERO:
CURRENTLY:    232.5 mmHg
SET TO:      0.0 mmHg

CONNECT VACUUM PUMP AND
← SAVE ZERO PRESSURE

RANGE  AVG  DIAGS  ALARM
  
```

Calibrate Pressure Span

The Calibrate Pressure Span screen allows the user to view and set the pressure sensor calibration span point.

Note The plumbing going to the pressure sensor should be disconnected so the sensor is reading ambient pressure before performing the span calibration. The operator should use an independent barometer to measure the ambient pressure and enter the value on this screen before calibrating. ▲

Note Wait at least 30 seconds for the reading to stabilize before saving the value. ▲

- In the Main Menu, choose Service > Pressure Calibration > **Span**.

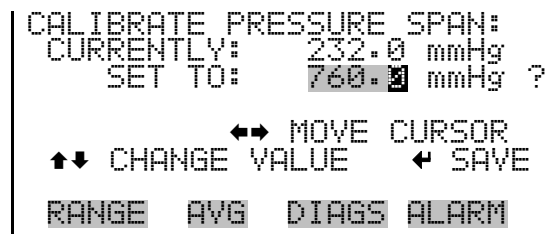

Restore Default Pressure Calibration

The Restore Default Pressure Calibration screen allows the user to reset the pressure calibration configuration values to factory defaults.

- In the Main Menu, choose Service > Pressure Calibration > **Set Defaults**.

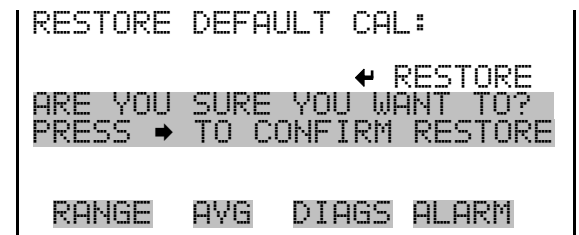

Flow Calibration

The Flow Calibration submenu is used to calibrate the flow sensor to zero, span, or restore factory default values. The flow calibration screen is visible

only when the instrument is in service mode. For more information on the service mode, see “[Service Mode](#)” earlier in the chapter.

Note This adjustment should only be performed by an instrument service technician. ▲

- In the Main Menu, choose Service > **Flow Calibration**.

```

FLOW SENSOR CAL:
>ZERO           200
SPAN           1.0000
SET DEFAULTS

RANGE  AVG  DIAGS  ALARM
  
```

Calibrate Flow Zero The Calibrate Flow Zero screen calibrates the flow sensor at zero flow.

Note The pump must be disconnected before performing the zero calibration. ▲

Note Wait at least 30 seconds for the reading to stabilize before saving the value. ▲

- In the Main Menu, choose Service > Flow Calibration > **Zero**.

```

CALIBRATE FLOW ZERO:
CURRENTLY:  0.004 LPM
SET TO:    0.000 LPM ?

DISCONNECT PUMP AND
← SAVE CURRENT FLOW

RANGE  AVG  DIAGS  ALARM
  
```

Calibrate Flow Span The Calibrate Flow Span screen allows the user to view and set the flow sensor calibration span point.

Note An independent flow sensor is required to read the flow, then the operator enters the flow value on this screen to perform the calibration. ▲

Note Wait at least 30 seconds for the reading to stabilize before saving the value. ▲

- In the Main Menu, choose Service > Flow Calibration > **Span**.

```
CALIBRATE FLOW SPAN:
CURRENTLY: 1.000 LPM
SET TO: 0.800 LPM ?

      ←→ MOVE CURSOR
↑↓ CHANGE VALUE  ← SAVE

RANGE  AVG  DIAGS  ALARM
```

Restore Default Flow Calibration

The Restore Default Flow Calibration screen allows the user to reset the flow calibration configuration values to factory defaults.

- In the Main Menu, choose Service > Flow Calibration > **Set Defaults**.

```
RESTORE DEFAULT CAL:

      ← RESTORE

RANGE  AVG  DIAGS  ALARM
```

```
RESTORE DEFAULT CAL:

      ← RESTORE
ARE YOU SURE YOU WANT TO?
PRESS → TO CONFIRM RESTORE

RANGE  AVG  DIAGS  ALARM
```

Input Board Calibration

The Input Board Calibration menu is used to initiate a calibration of the input board A/D stages. The input board calibration menu is visible only when the instrument is in service mode. For more information on the service mode, see “[Service Mode](#)” earlier in the chapter.

Note This adjustment should only be performed by an instrument service technician. ▲

- In the Main Menu, choose Service > **Input Board Calibration**.

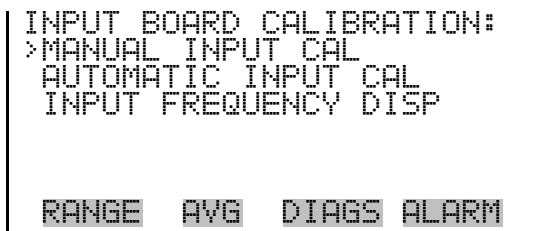

Manual Input Calibration

The Manual Input Calibration screen is used to do a manual calibration of the input board A/D stages per the following procedure:

Note The measurement system and the PMT are both shut off inside this screen. ▲

1. In the Main Menu, choose Service > Input Board Calibration > **Manual Input Cal.**
2. Press to leave warning screen.
3. Make a note of the frequency at gain of 1.
4. Use and to change the gain from 1 to 100.
5. Use and to increment or decrement the D/A counts so the frequency at gain 100 matches or is slightly above the frequency at gain 1 (within 50 counts).
6. Press to save new input board calibration.

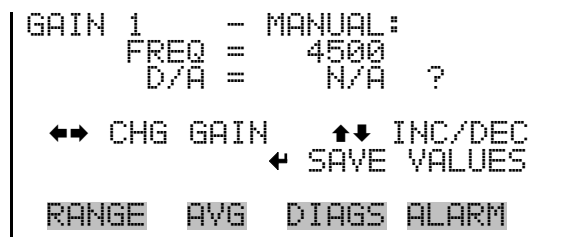
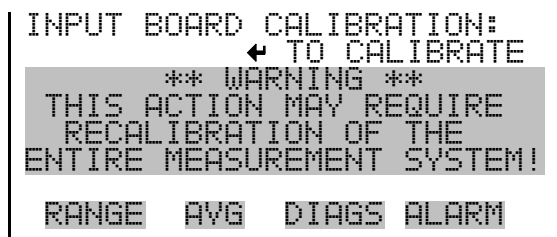

Automatic Input Calibration

The Automatic Input Calibration screen is used to do an automatic calibration of the input board A/D stages. A message will be displayed after the optimum setting has been determined.

Note The measurement system and the PMT are both shut off inside this screen. ▲





- In the Main Menu, choose Service > Input Board Calibration > **Automatic Input Cal.**
- Press  to leave warning screen and begin automatic calibration.

```
INPUT BOARD CALIBRATION:
      ← TO CALIBRATE
** WARNING **
THIS ACTION MAY REQUIRE
RECALIBRATION OF THE
ENTIRE MEASUREMENT SYSTEM!
RANGE  AVG  DIAGS  ALARM
```

```
INPUT BOARD CALIBRATION:
      ** IN PROGRESS **
D/A    =    2047
TARGET =     0
FREQ   =     0      0
ZERO   =     0 CNT = 1
RANGE  AVG  DIAGS  ALARM
```

Input Frequency Display

The Input Frequency Display screen is used to manually adjust the input board gain. This may be used as a troubleshooting tool to ensure that the input board is working properly. The gain setting and test mode are reset upon exiting this screen. (That is, no changes are saved.)

- In the Main Menu, choose Service > Input Board Calibration > **Input Frequency Disp.**
- Press  to leave warning screen.
- Use  and  to toggle the test signal (between ON and OFF).
- Use  and  to change the gain between 1, 10 and 100.

```
INPUT BOARD CALIBRATION:
      ← TO CALIBRATE
** WARNING **
CONCENTRATION CALCULATION
IS HALTED INSIDE
THIS SCREEN!
RANGE  AVG  DIAGS  ALARM
```

```
INPUT GAIN TEST:
GAIN = 1
TEST = OFF
FREQ = 5000
↔ CHG GAIN ↑↓ TEST MODE
RANGE  AVG  DIAGS  ALARM
```

Temperature Calibration

The Temperature Calibration screen allows the user to view and set the ambient temperature sensor offset, which basically adjusts the temperature sensor so that it reads correctly. The temperature calibration is visible only when the instrument is in service mode. For more information on the service mode, see “[Service Mode](#)” earlier in the chapter.

Note This adjustment should only be performed by an instrument service technician. ▲

Note Wait at least 30 seconds for the reading to stabilize before saving the value. ▲

- In the Main Menu, choose Service > **Temperature Calibration**.

```

CALIBRATE AMBIENT TEMP:
CURRENTLY:          32.3 C
SET TO:             032.0 °C ?

      ←→ MOVE CURSOR
↑↓ CHANGE VALUE   ← SAVE

RANGE  AVG  DIAGS  ALARM
  
```

Analog Output Calibration

The Analog Output Calibration menu provides access to the 6 voltage channels and 6 current channels for calibration. Current channels are visible only if the I/O expansion board is installed. The analog output calibration menu is visible only when the instrument is in service mode. For more information on the service mode, see “[Service Mode](#)” earlier in the chapter.

Note This adjustment should only be performed by an instrument service technician. ▲

- In the Main Menu, choose Service > **Analog Out Cal.**

```

ANALOG OUTPUT CAL:
>VOLTAGE CHANNEL 1
VOLTAGE CHANNEL 2
VOLTAGE CHANNEL 3
VOLTAGE CHANNEL 4
VOLTAGE CHANNEL 5      ↓

RANGE  AVG  DIAGS  ALARM
  
```

```
ANALOG OUTPUT CAL:
>CALIBRATE ZERO
CALIBRATE FULL SCALE

RANGE  AVG  DIAGS  ALARM
```

Analog Output Calibrate Zero

The Analog Output Calibrate Zero screen allows the user to calibrate the zero state of the selected analog output. The operator must connect a volt meter to the output and adjust the output until it reads 0.0 V on the meter for a voltage channel, or either 0 or 4 mA for a current channel (depending on the selected range). See the “set output to:” field on the display.

- In the Main Menu, choose Service > Analog Out Cal > select Channel > **Calibrate Zero**.

```
ANALOG OUTPUT CAL:  ZERO
CONNECT METER TO OUTPUT!
SELECTED OUTPUT:    V1
SET TO:             100
← SAVE VALUE      ↑↓ INC/DEC
SET OUTPUT TO:     0.0 V

RANGE  AVG  DIAGS  ALARM
```

Analog Output Calibrate Full-Scale

The Analog Output Calibrate Full-Scale screen allows the user to calibrate the full-scale state of the selected analog output. The operator must connect a volt meter to the output and adjust the output until the meter reads the value shown in the “set output to:” field, in either V or mA, depending on the selected output channel.

- In the Main Menu, choose Service > Analog Out Cal > select Channel > **Calibrate Full Scale**.

```
ANALOG OUTPUT CAL:  SPAN
CONNECT METER TO OUTPUT!
SELECTED OUTPUT:    V1
SET TO:             3397
← SAVE VALUE      ↑↓ INC/DEC
SET OUTPUT TO:     10 V

RANGE  AVG  DIAGS  ALARM
```

Analog Input Calibration

The Analog Input Calibration menu is used to calibrate the 8 analog input channels at both zero and full-scale. The Analog Input Calibration menu is

visible only when the I/O expansion board is installed. The analog input calibration menu is visible only when the instrument is in service mode. For more information on the service mode, see “Service Mode” earlier in the chapter.

Note This adjustment should only be performed by an instrument service technician. ▲

- In the Main Menu, choose Service > **Analog Input Cal.**

```

ANALOG INPUT CAL:
>INPUT CHANNEL 1
  INPUT CHANNEL 2
  INPUT CHANNEL 3
  INPUT CHANNEL 4
  INPUT CHANNEL 5
                                     ↓
RANGE  AVG  DIAGS  ALARM
  
```

```

ANALOG INPUT CAL:
>CALIBRATE ZERO
  CALIBRATE FULL SCALE
                                     ↓
RANGE  AVG  DIAGS  ALARM
  
```

Analog Input Calibrate Zero

The Analog Input Calibrate Zero screen allows the user to calibrate the zero state of the selected analog input.

- In the Main Menu, choose Service > Analog Input Cal > select Channel > **Calibrate Zero.**

```

ANALOG INPUT CAL:  ZERO
DISCONNECT SELECTED INPUT!
SELECTED INPUT:    INPUT 1
CURRENTLY:         0.04 V
← CALIBRATE INPUT TO ZERO
RANGE  AVG  DIAGS  ALARM
  
```

Analog Input Calibrate Full-Scale

The Analog Input Calibrate Full-Scale screen allows the user to calibrate the full-scale state of the selected analog input.

- In the Main Menu, choose Service > Analog Input Cal > select Channel > **Calibrate Full Scale**. (Hook up a voltage source of 10 V to the analog input channel.)

```
ANALOG INPUT CAL:      SPAN
PROVIDE VOLTAGE TO INPUT!
SELECTED INPUT:      INPUT 1
CURRENTLY:           9.84 V
SET TO:              10.00 V
← CALIBRATE TO VALUE

RANGE  AVG  DIAGS  ALARM
```

Permeation Oven Settings

The Permeation Oven Settings menu is used for setting up and calibrating the permeation oven option. The permeation oven settings are visible only if the permeation oven option installed and when the calibrator is in service mode. For more information on the service mode, see “[Service Mode](#)” earlier in this chapter.

- In the Main Menu, choose Service > **Perm Oven Settings**.

Note This adjustment should only be performed by an instrument service technician. ▲

```
PERM OVEN SETTINGS:
>CAL GAS THERMISTOR
CAL OVEN THERMISTOR
PERM OVEN SELECTION
FACTORY CAL GAS THERM
FACTORY CAL OVEN THERM

RANGE  AVG  DIAGS  ALARM
```

Calibrate Gas Thermistor

The Calibrate Gas Thermistor menu is used for calibrating the permeation oven gas thermistor using a water bath or known resistance.

- In the Main Menu, choose Service > Perm Oven Settings > **Cal Gas Thermistor**.

```

CALIBRATE GAS THERMISTOR:
>WATER BATH
  KNOWN RESISTOR

RANGE  AVG  DIAGS  ALARM
  
```

Water Bath The Calibrate Gas Thermistor Water Bath screen is used to view and set the permeation oven gas temperature to a known temperature value.

- In the Main Menu, choose Service > Perm Oven Settings > Cal Gas Thermistor > **Water Bath**.

```

CAL GAS THERM (BATH):
CURRENTLY:      45.80 °C
SET TO:        45.00 °C

      ←→ MOVE CURSOR
↑↓ CHANGE VALUE  ← SAVE

RANGE  AVG  DIAGS  ALARM
  
```

Resistor The Calibrate Gas Thermistor Resistor screen is used to view and set the permeation oven gas thermistor resistance to a known resistor value.

- In the Main Menu, choose Service > Perm Oven Settings > Cal Gas Thermistor > **Known Resistor**.

```

CAL GAS THERM (RESISTOR):
CURRENTLY:      3850 Ohms
SET TO:        0400 Ohms

      ←→ MOVE CURSOR
↑↓ CHANGE VALUE  ← SAVE

RANGE  AVG  DIAGS  ALARM
  
```

Calibrate Oven Thermistor The Calibrate Oven Thermistor screen is used to view and set the permeation oven thermistor resistance to a known resistor value.

- In the Main Menu, choose Service > Perm Oven Settings > **Cal Oven Thermistor**.

```
CAL OVEN THERM (RESISTOR):  
CURRENTLY: 3850 Ohms  
SET TO: 04000 Ohms  
  
↔ MOVE CURSOR  
↑↓ CHANGE VALUE ← SAVE  
  
RANGE AVG DIAGS ALARM
```

Permeation Oven Selection The Permeation Oven Setpoint screen is used to select the permeation oven state to not present, or the desired temperature choice of 30, 35, and 45 °C.

- In the Main Menu, choose Service > Perm Oven Settings > **Perm Oven Selection**.

```
PERM OVEN SETPOINT:  
CURRENTLY: NOT PRESENT  
SET TO: 45 °C ?  
  
↔ MOVE CURSOR  
↑↓ CHANGE VALUE ← SAVE  
  
RANGE AVG DIAGS ALARM
```

Factory Calibrate Gas Thermistor The Factory Calibrate Gas Thermistor menu is used for calibrating the permeation oven gas thermistor to either low point, high point, or set defaults.

- In the Main Menu, choose Service > Perm Oven Settings > **Factory Cal Gas Therm.**

```
FACTORY CAL GAS THERM:  
>LOW POINT  
HIGH POINT  
SET DEFAULTS  
  
RANGE AVG DIAGS ALARM
```

Low and High Points The Calibrate Gas Thermistor Low Point screen is used to view and set the permeation oven thermistor resistance. The low and high point screens function the same way.

- In the Main Menu, choose Service > Perm Oven Settings > Factory Cal Gas Therm > **Low or High Point**.

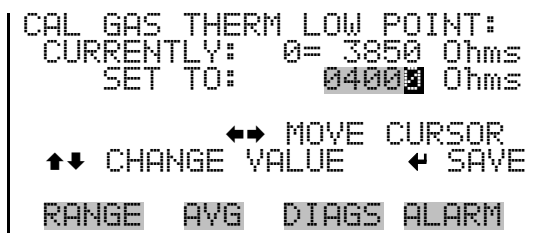

Set Defaults The Set Defaults screen is used to reset the configuration values to factory defaults.

- In the Main Menu, choose Service > Perm Oven Settings > Factory Cal Gas Therm > **Set Defaults**.

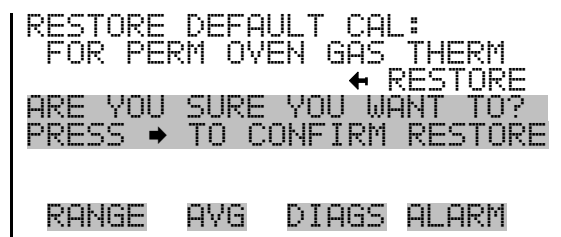
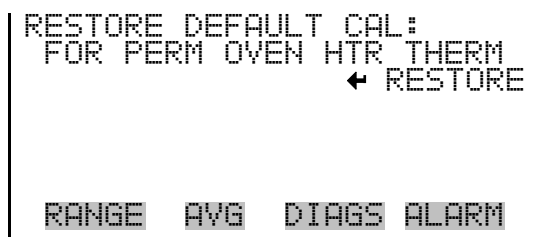

Factory Calibrate Oven Thermistor

The Factory Calibrate Oven Thermistor menu is used for calibrating the permeation oven heater thermistor to either low point, high point, or set defaults.

- In the Main Menu, choose Service > Perm Oven Settings > **Factory Cal Oven Therm**.

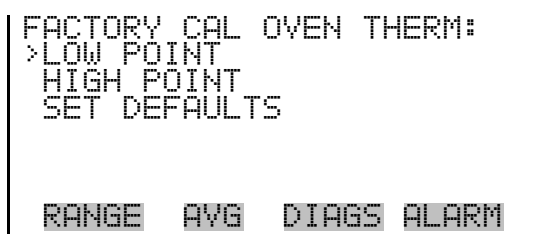

Low and High Points

The Calibrate Oven Thermistor Low Point screen is used to view and set the permeation oven thermistor resistance. The low and high point screens function the same way.

- In the Main Menu, choose Service > Perm Oven Settings > Factory Cal Oven Therm > **Low or High Point**.

```
CAL OVEN THERM LOW POINT:
CURRENTLY: 0= 3850 Ohms
SET TO: 04000 Ohms

      ←← MOVE CURSOR
↑↓ CHANGE VALUE ← SAVE

RANGE  AVG  DIAGS  ALARM
```

Set Defaults The Set Defaults screen is used to reset the configuration values to factory defaults.

- In the Main Menu, choose Service > Perm Oven Settings > Factory Cal Oven Therm > **Set Defaults**.

```
RESTORE DEFAULT CAL:
FOR PERM OVEN HTR THERM
      ← RESTORE

RANGE  AVG  DIAGS  ALARM
```

```
RESTORE DEFAULT CAL:
FOR PERM OVEN HTR THERM
      ← RESTORE
ARE YOU SURE YOU WANT TO?
PRESS → TO CONFIRM RESTORE

RANGE  AVG  DIAGS  ALARM
```

Ozonator Safety The Ozonator Safety screen is used to turn the ozonator safety feature on or off. If the ozonator safety is turned off, the ozonator will always be on, even if the converter is not up to temperature. The ozonator shuts of if there is a converter temperature alarm or an ozone flow alarm. If the safety override is on, the instrument generates an ozone flow alarm.

The ozonator safety screen is visible only when the instrument is in service mode. For more information on the service mode, see “[Service Mode](#)” earlier in the chapter.

- In the Main Menu, choose Service > **Ozonator Safety**.

```
OZONATOR SAFETY:
CURRENTLY: OFF
SET TO: ON ?

      ← TOGGLE VALUE

RANGE  AVG  DIAGS  ALARM
```

Extended Ranges

The Extended Ranges screen is used to turn the extended ranges feature on and off. The extended ranges screen is visible only when the instrument is in service mode. For more information on the service mode, see “[Service Mode](#)” earlier in the chapter.

- In the Main Menu, choose Service > **Extended Ranges**.
- Press  to toggle and set the extended ranges on or off.



Dilution Ratio

The Dilution Ratio screen allows the user to view and set the dilution ratio. Acceptable values are 1–500: 1. The default is 1:1. When this value is set, the dilution ratio is applied to all concentration measurements. This screen is only accessible if the dilution ratio option is installed.

- In the Main Menu, choose Service > **Dilution Ratio**.

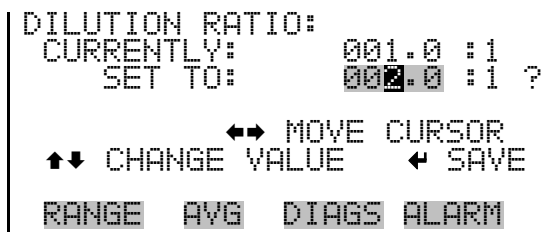

Display Pixel Test

The Display Pixel Test is used to test the LCD display. The display pixel test is visible only when the instrument is in service mode. For more information on the service mode, see “[Service Mode](#)” earlier in the chapter.

- In the Main Menu, choose Service > **Display Pixel Test**.

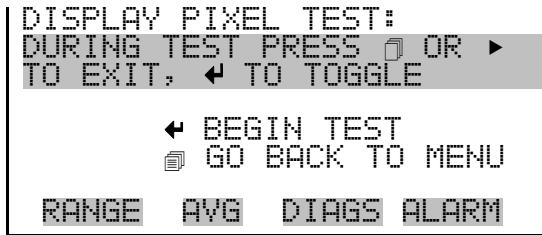

Restore User Defaults The Restore User Defaults screen is used to reset the user calibration and configuration values to factory defaults. The restore user defaults screen is visible only when the instrument is in service mode. For more information on the service mode, see “[Service Mode](#)” earlier in the chapter.

- In the Main Menu, choose Service > **Restore User Defaults**.

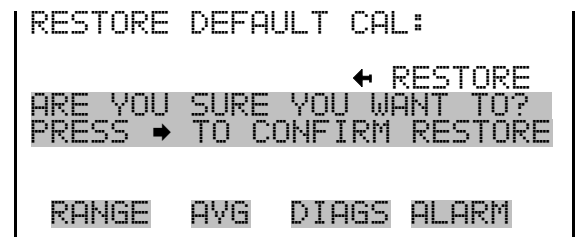
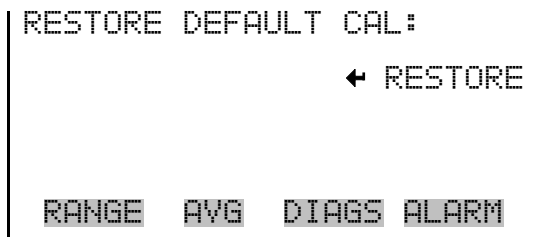

Password Menu The Password menu allows the user to configure password protection. If the instrument is “locked”, none of the settings may be changed via the front panel user interface, but they can still be changed via remote operation. When the front panel is locked, the user can still navigate the menu and view data, instrument parameters, and settings, but nothing can be changed. The password (lock) icon on the right side of the status bar indicates that the password lock is active. The items visible under the Password menu are determined by the instrument’s password status.

- In the Main Menu, choose **Password**.

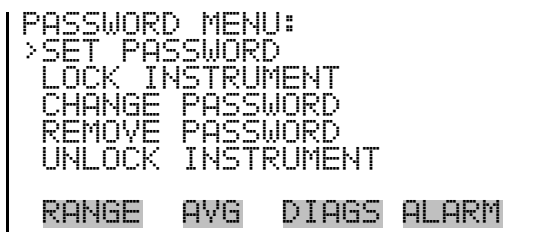

Set Password

The Set Password screen is used to set the password that is used to unlock the front panel, and is shown if the instrument is unlocked and the password is not set.

- In the Main Menu, choose Password > **Set Password**



Lock Instrument

The Lock Instrument screen is used to lock the instrument's front panel so users cannot change any settings from the front panel. The lock instrument screen is shown if the instrument is unlocked and the password is set.

- In the Main Menu, choose Password > **Lock Instrument**



Lock/Unlock and Local/Remote Operation

If the instrument is locked via the front panel using Password > **Lock Instrument**, the instrument reports being in Remote mode. In this mode, the front panel is “locked”, where data can be viewed, settings can be viewed but not changed using the front panel interface, and the remote “Set” commands are active.

If the instrument keyboard is unlocked via the front panel using Password > **Unlock Instrument**, the instrument reports being in Local mode, the front panel interface is unlocked, and settings can be changed from the front panel.

Refer to “[C-Link Protocol Commands](#)” appendix for detailed information about “mode”, “allow mode”, and “power up mode” commands.

Change Password

The Change Password screen is used to change the password used to unlock the instrument's front panel. The change password screen is shown if the instrument is unlocked.

- In the Main Menu, choose Password > **Change Password**



Remove Password

The Remove Password screen is used to erase the current password and disable password protection. The remove password screen is shown if the instrument is unlocked and the password is set.

- In the Main Menu, choose Password > **Remove Password**



Unlock Instrument

The Unlock Instrument screen is used to enter the password to unlock the front panel. The unlock instrument screen is shown if the instrument is locked.

- In the Main Menu, choose Password > **Unlock Instrument**



Chapter 4

Calibration

This chapter describes procedures for performing a multipoint calibration of the Model 42*i*. The information described here is considered adequate to perform the calibration. However, if greater detail is desired, the user is referred to the Code of Federal Regulations, Title 40, Part 50, Appendix F.

The calibration technique is based on the rapid gas phase reaction between NO and O₃ which produces stoichiometric quantities of NO₂ in accordance with the reaction:

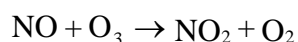

The quantitative nature of this reaction is such that when the NO concentration is known, the concentration of NO₂ can be determined. Ozone is added to excess NO in a dynamic calibration system, and the NO channel of the chemiluminescence NO-NO₂-NO_x analyzer is used as an indicator of changes in NO concentration.

When O₃ is added, the decrease in NO concentration observed on the calibrated NO channel is equivalent to the concentration of NO₂ produced. Adding variable amounts of O₃ from a stable O₃ generator can change the amount of NO₂ generated. The following sections discuss the required apparatus and procedures for calibrating the instrument:

- [“Equipment Required”](#) on page 4-1
- [“Pre-Calibration”](#) on page 4-8
- [“Calibration”](#) on page 4-9
- [“Calibration in Dual Range and Auto Range Mode”](#) on page 4-16
- [“Zero and Span Check”](#) on page 4-20

Equipment Required

The following equipment is required to calibrate the analyzer:

- Zero gas generator
- Gas phase titrator

Zero Gas Generator

A zero air source, such as a Thermo Scientific *Model 111 Zero Air Supply* or *Model 1160 Zero Air Supply*, free of contaminants such as NO, NO₂, and O₃ is required for dilution, calibration, and gas phase titration.

Compression

The zero air source should be at an elevated pressure to allow accurate and reproducible flow control and to aid in subsequent operations such as drying, oxidation, and scrubbing. An air compressor that gives an output of 10 psig is usually sufficient for most applications.

Drying

Several drying methods are available. Passing the compressed air through a bed of silica gel, using a heatless air dryer, or removing water vapor with a permeation dryer are three possible approaches.

Oxidation

NO is usually oxidized to NO₂ in order to ease its scrubbing. Oxidation can be accomplished by either ozonation or chemical contact. During ozonation, the air is passed through an ozone generator. The O₃ that is produced reacts with the NO to form NO₂. Care must be taken to allow sufficient residence time for the ozonation reaction to go to completion.

Chemical oxidation is accomplished by passing the air stream through a reacting bed. Such agents as CrO₃ on an alumina support or Purafil® are very efficient at oxidizing NO to NO₂. The chemical contact approach has the advantage of needing no electrical power input for its application.

Scrubbing

Fixed bed reactors are commonly used in the last step of zero air generation to remove the remaining contaminants by either further reaction or absorption. [Table 4–1](#) lists materials that can be effective in removing contaminants.

Table 4–1. Scrubbing Materials

To Remove	Use
NO ₂	Soda-Lime (6-12 mesh), Purafil
Hydrocarbons	Molecular Sieve (4A), Activated Charcoal
O ₃ and SO ₂	Activated Charcoal

Gas Phase Titrator

A gas phase titrator (GPT), such as is included in the Thermo Scientific Model 146 Series Multigas Calibration System is used to generate NO_2 concentrations from NO concentrations. Figure 4–1 shows the suggested placement of the component parts of a gas phase titration apparatus.



Equipment Damage All connections between components in the system should be made with glass, Teflon®, or other non-reactive material. ▲

Flow Controllers

The airflow controllers should be devices capable of maintaining constant airflows within $\pm 2\%$ of the required flow rate. The NO flow controller should be capable of maintaining constant NO flows within $\pm 2\%$ of the required flow rate.

Pressure Regulator

The pressure regulator for the standard NO cylinder must have a non-reactive diaphragm and internal parts, and a suitable delivery pressure.

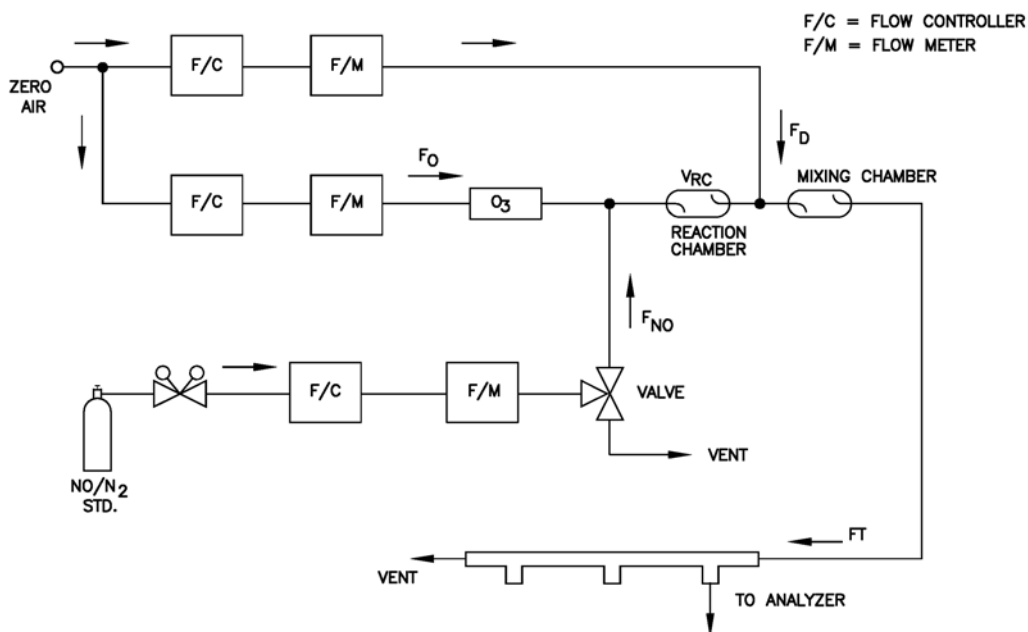

Figure 4–1. GPT System

Ozone Generator The ozone generator must be capable of generating sufficient and stable levels of ozone for reaction with NO to generate NO₂ concentrations in the range required.

Note Ozone generators of the electric discharge type may produce NO and NO₂ and are not recommended. ▲

Diverter Valve A valve can be used to divert the NO flow when zero air is required at the manifold.

Reaction Chamber The reaction chamber used for the reaction of ozone with excess NO should have sufficient volume so that the residence time meets the requirements specified in this chapter.

Mixing Chamber The mixing chamber is used to provide thorough mixing of the reaction products and diluent air.

Output Manifold The output manifold should be of sufficient diameter to insure an insignificant pressure drop at the analyzer connection. The system must have a vent designed to insure atmospheric pressure at the manifold and to prevent ambient air from entering the manifold.

Reagents The following information describes the NO concentration standard and the method for calculating the NO concentration standard and the NO₂ impurity.

NO Concentration Standard A cylinder containing 10 to 50 ppm NO in N₂ with less than 1 ppm NO₂ is usually used as the concentration standard. The cylinder must be traceable to a National Institute of Standards and Technology (NIST) NO in N₂ Standard Reference Material or NO₂ Standard Reference Material.

Procedures for certifying the NO cylinder (working standard) against an NIST traceable NO or NO₂ standard and for determining the amount of NO₂ impurity are given in EPA Publication No. EPA-600/4-75-003, "Technical Assistance Document for the Chemiluminescence Measurement of Nitrogen Dioxide."

In addition, the procedure for the certification of a NO working standard against an NIST traceable NO standard and determination of the amount of NO₂ impurity in the working standard is reproduced here. The cylinder should be re-certified on a regular basis as determined by the local quality control program.

Use the NIST traceable NO standard and the GPT calibration procedure to calibrate the NO, NO_x, and NO₂ responses of the instrument. Also determine the converter efficiency of the analyzer. Refer to the calibration procedure in this manual and in the Code of Federal Regulations, Title 40, Part 50, Appendix F for exact details. Ignore the recommended zero offset adjustments.

Assaying a Working NO Standard Against a NIST-traceable NO Standard

Use the following procedure to calculate the NO concentration standard and NO₂ impurity.

1. Generate several NO concentrations by dilution of the NO working standard.
2. Use the nominal NO concentration, [NO]_{NOM}, to calculate the diluted concentrations.
3. Plot the analyzer NO response (in ppm) versus the nominal diluted NO concentration and determine the slope, S_{NOM}.
4. Calculate the [NO] concentration of the working standard, [NO]_{STD}, from:

$$[\text{NO}]_{\text{STD}} = [\text{NO}]_{\text{NOM}} \times S_{\text{NOM}}$$

5. If the nominal NO concentration of the working standard is unknown, generate several NO concentrations to give on-scale NO responses.
6. Measure and record F_{NO} and F_T for each NO concentration generated.
7. Plot the analyzer NO response versus F_{NO}/F_T and determine the slope which gives [NO]_{STD} directly. The analyzer NO_x responses to the generated NO concentrations reflect any NO₂ impurity in the NO working standard.

8. Plot the difference between the analyzer NO_x and NO responses versus $F_{\text{NO}}/F_{\text{T}}$. The slope of this plot is $[\text{NO}_2]_{\text{IMP}}$.

Zero Air A source of zero air free of contaminants should be used as described earlier in this chapter. Contaminants can cause a detectable response on the instrument and may also react with the NO, O_3 , or NO_2 during the gas phase titration.

Dynamic Parameter Specifications for Gas Titrator

Use the following definitions for the remainder of this chapter.

P_{R} =	Dynamic parameter specification to ensure complete reaction of the available O_3 , ppm-min
$[\text{NO}]_{\text{RC}}$ =	NO concentration in the reaction chamber, ppm
t_{R} =	residence time of the reactant gases in the reaction chamber, min
$[\text{NO}]_{\text{STD}}$ =	Concentration of the undiluted NO standard, ppm
F_{NO} =	NO flow rate, sccm
F_{O} =	O_3 generator air flow rate, sccm
V_{RC} =	Volume of the reaction chamber, cc
F_{T} =	Analyzer demand plus 10 to 50% excess

The O_3 generator (ozonator) airflow rate and the NO flow rate must be adjusted such that the following relationships hold:

$$P_{\text{R}} = [\text{NO}]_{\text{RC}} \times t_{\text{R}} \geq 2.75 \text{ ppm} \cdot \text{min}$$

$$[\text{NO}]_{\text{RC}} = [\text{NO}]_{\text{STD}} \frac{F_{\text{NO}}}{(F_{\text{O}} + F_{\text{NO}})}$$

$$t_{\text{R}} = \frac{V_{\text{RC}}}{F_{\text{O}} + F_{\text{NO}}} < 2 \text{ min}$$

Determining GPT System Flow Conditions

Use the following procedure to determine the flow conditions to be used in the GPT system.

1. Determine F_{T} , the total flow required at the output manifold, which should be equal to the analyzer demand plus 10 to 50 percent excess.

2. Establish $[\text{NO}]_{\text{OUT}}$ as the highest NO concentration that will be required at the output manifold. $[\text{NO}]_{\text{OUT}}$ should be about equal to 90% of the upper range limit (URL) of the NO_2 concentration range to be covered.

3. Determine F_{NO} as:

$$F_{\text{NO}} = \frac{[\text{NO}]_{\text{OUT}} \times F_{\text{T}}}{[\text{NO}]_{\text{STD}}}$$

4. Select a convenient or available reaction chamber volume. Initially a trial volume may be selected in the range of 200 to 500 cc.

5. Compute F_{O} as:

$$F_{\text{O}} = \sqrt{\frac{[\text{NO}]_{\text{STD}} \times F_{\text{NO}} \times V_{\text{RC}}}{2.75}} - F_{\text{NO}}$$

6. Compute t_{R} as:

$$t_{\text{R}} = \frac{V_{\text{RC}}}{F_{\text{O}} + F_{\text{NO}}}$$

7. Verify that $t_{\text{R}} < 2$ minutes. If not, select a reaction chamber with a smaller V_{RC} .

8. Compute the diluent air flow rate as:

$$F_{\text{D}} = F_{\text{T}} - F_{\text{O}} - F_{\text{NO}}$$







9. If F_{O} turns out to be impractical for the desired system, select a reaction chamber having a different V_{RC} and recompute F_{D} and F_{O} .

Pre-Calibration

Perform the following pre-calibration procedure before calibrating the Model 42*i*. For detailed information about the menu parameters and the icons used in these procedures, see the “[Operation](#)” chapter.

Note The calibration and calibration check duration times should be long enough to account for the transition (purge) process when switching from sample to zero and from zero to span. This transition time is the time required to purge the existing air. ▲

Depending on the plumbing configuration and the instrument, data from approximately the first minute of a zero calibration or check should be disregarded because of residual sample air. Also, data from approximately the first minute of a span calibration or check should be disregarded because the span is mixing with the residual zero air. ▲

1. Allow the instrument to warm up and stabilize.
2. Be sure the ozonator is ON. If the ozonator is not ON:
 - a. Press  to display the Main Menu, then choose Instrument Controls > **Ozonator**.
 - b. Press  to toggle the ozonator ON.
 - c. Press  to return to the Run screen.
3. Be sure the instrument is in the auto mode, that is, NO, NO₂, and NO_x measurements are being displayed on the front panel display. If the instrument is not in auto mode:
 - a. Press  to display the Main Menu, then choose Instrument Controls > **Auto/Manual Mode**.
 - b. Select **NO/NO_x**, and press .
 - c. Press  to return to the Run screen.
4. Select NO, NO₂, and NO_x ranges, and push the AVG soft key to display the Averaging Time screen. It is recommended that a higher averaging time be used for best results. For more information about the ranges or averaging time, see the “[Operation](#)” chapter.

Note The averaging time should be less than the zero duration and less than the span duration. ▲

5. Verify that any filters used during normal monitoring are also used during calibration.
6. If required, connect the analog/digital outputs to a strip chart recorder(s) or PC(s).

Calibration

The following procedure calibrates the analyzer using the gas phase titrator and zero gas generator described previously in this manual. It is suggested that a calibration curve have at least seven points between the zero and full scale NO concentrations. Although the seven-point curve is optional, two of whatever number of points is chosen should be located at the zero and 90% levels and the remaining points equally spaced between these values.

Note When the instrument is equipped with internal zero/span and sample valves, the ZERO and SPAN ports should give identical responses to the SAMPLE port when test gases are introduced. The user should calibrate the instrument using the SAMPLE port to introduce the zero and span gas sources. ▲

After calibration, the zero and span sources should be plumbed to the appropriate ports on the rear panel of the instrument, and then reintroduced to the instrument. The instrument should give identical responses to the test gases whether they are introduced via the SAMPLE port or the ZERO or SPAN ports. If not, the plumbing and/or valves should be serviced.

Connect GPT Apparatus to the Analyzer

Use the following procedure to connect the GPT apparatus to the analyzer.

1. Assemble a dynamic calibration system such as the one shown in Figure 4-1.
2. Ensure that all flow meters are calibrated under the conditions of use against a reliable standard, such as a soap-bubble meter or wet-test meter. All volumetric flow rates should be corrected to 25 °C and 760 mmHg.

3. Precautions should be taken to remove O₂ and other contaminants from the NO pressure regulator and delivery system prior to the start of calibration to avoid any conversion of NO to NO₂. Failure to do so can cause significant errors in calibration. This problem can be minimized by:
 - a. Carefully evacuating the regulator after the regulator has been connected to the cylinder and before opening the cylinder valve.
 - b. Thoroughly flushing the regulator and delivery system with NO after opening the cylinder valve.
 - c. Not removing the regulator from the cylinder between calibrations unless absolutely necessary.
4. Connect the analyzer sample bulkhead input to the output of the GPT system.

Adjust Instrument Gain

Use the following procedure to adjust the instrument gain. This includes:

- Setting the NO and NO_x background to zero
- Calibrating the NO channel to the NO calibration gas
- Calibrating the NO_x channel to the NO_x calibration gas

Set NO and NO_x Background to Zero



The NO and NO_x background corrections are determined during zero calibration. The background signal is the combination of electrical offsets, PMT dark current, and trace substances undergoing chemiluminescence. For more detailed information, see “[Calibrate NO and NO_x Backgrounds](#)” in the “[Operation](#)” chapter.

Use the following procedure to set the NO background. Both the NO and NO_x background screens operate the same way, therefore, the following procedure also applies to the NO_x background screen.

Note The NO channel should be calibrated first and then calibrate the NO_x channel. ▲

For detailed information about the menu parameters and the icons used in these procedures, see the “[Operation](#)” chapter.

1. Determine the GPT flow conditions required to meet the dynamic parameter specifications as indicated in “Dynamic Parameter Specifications for Gas Titrator” earlier in this chapter.

2. Adjust the GPT diluent air and O₃ generator air flows to obtain the flows determined in “Dynamic Parameter Specifications for Gas Phase Titrator” earlier in this chapter. The total GPT airflow must exceed the total demand of the analyzer. The Model 42*i* requires approximately 700 cc/min of sample flow, and a total GPT airflow of at least 1.5 liters/min is recommended.
 - a. Allow the analyzer to sample zero air until the NO, NO_x, and NO₂ responses stabilize.
 - b. After the responses have stabilized, from the Main Menu, choose Calibration > **Cal NO Background**.
 - c. Press  to set the NO reading to zero.
 - d. Press  to return to the Calibration menu and repeat this procedure to set the NO_x background to zero.
 - e. Record the stable zero air responses as Z_{NO}, Z_{NOX}, and Z_{NO2} (recorder response, percent scale).

3. Adjust the NO flow from the standard NO cylinder to generate a NO concentration of about 80% of the upper range limit (URL) of the NO range. The exact NO concentration is calculated from:

$$[\text{NO}]_{\text{OUT}} = \frac{F_{\text{NO}} \times \text{NO}_{\text{STD}}}{F_{\text{NO}} + F_{\text{O}} + F_{\text{D}}}$$

Where:

[NO]_{OUT} = Diluted NO concentration at the output manifold, ppm

NO_{STD} = No feed concentration

F_{NO} = No flow

F_O = Ozone flow

F_D = Dilution flow





Calibrate the NO Channel to the NO Calibration Gas

Use the following procedure to calibrate the NO channel to the NO calibration gas.

1. Allow the analyzer to sample the NO calibration gas until the NO, NO₂, and NO_x readings have stabilized.

2. When the responses stabilize, from the Main Menu, choose Calibration > **Cal NO Coefficient**.

The NO line of the Calibrate NO screen displays the current NO concentration. The SPAN CONC line of the display is where you enter the NO calibration gas concentration.

Use   to move the cursor left and right and use   to increment and decrement the numeric character at the cursor.

3. Press  to calculate and save the new NO coefficient based on the entered span concentration.

The NO recorder response will equal:

$$\text{Recorder Response (\% scale)} = \frac{[\text{NO}]_{\text{OUT}}}{\text{URL}} \times 100 + Z_{\text{NO}}$$

Where:

URL = Nominal upper range limit of the NO channel, ppm

4. Record the $[\text{NO}]_{\text{OUT}}$ concentration and the analyzer NO response as indicated by the recorder response.





Calibrate the NO_x Channel to the NO_x Calibration Gas



Use the following procedure to calibrate the NO_x channel to the NO_x calibration gas.

1. Press  to return to the Calibration menu, and choose **Cal NO_x Coefficient**.

2. Verify that the NO_x calibration gas concentration is the same as the NO calibration gas concentration plus any known NO₂ impurity.

The NO_x line of the Calibrate NO_x screen displays the current NO_x concentration. The SPAN CONC line of the display is where you enter the NO_x calibration gas concentration.

Use   to move the cursor left and right and use   to increment and decrement the numeric character at the cursor.

3. Press  to calculate and save the new NO_x coefficient based on the entered span concentration.
4. Press  to return to the Run screen. The exact NO_x concentration is calculated from:

$$[\text{NO}_x]_{\text{OUT}} = \frac{F_{\text{NO}} \times ([\text{NO}]_{\text{STD}} + [\text{NO}_2]_{\text{IMP}})}{F_{\text{NO}} + F_{\text{O}} + F_{\text{D}}}$$

Where:

$[\text{NO}_x]_{\text{OUT}}$ = diluted NO_x concentration at the output manifold, ppm

$[\text{NO}_2]_{\text{IMP}}$ = concentration of NO_2 impurity in the standard NO cylinder, ppm

The NO_x recorder response will equal:

$$\text{Recorder Response (\% scale)} = \frac{[\text{NO}_x]_{\text{OUT}}}{\text{URL}} \times 100 + Z_{\text{NO}_x}$$

Where:

URL = Nominal upper range limit of the NO_x channel, ppm





5. Record the NO_x concentration and the analyzer's NO_x response.

Preparing NO, NO_x , and NO_2 Calibration Curves

Use the following procedures to prepare the NO, NO_x , and NO_2 calibration curves.

1. Generate several additional NO and NO_x concentrations by decreasing F_{NO} or increasing F_{D} .
2. For each concentration generated, calculate the exact NO and NO_x concentrations using the above equations for $[\text{NO}]_{\text{OUT}}$ and $[\text{NO}_x]_{\text{OUT}}$.
3. Record the NO and NO_x responses.
4. Plot the analyzer responses versus the respective calculated NO and NO_x concentrations and draw or calculate the respective calibration curves. For subsequent calibrations where linearity can be assumed, these curves may be checked with a three-point calibration consisting of a zero point, NO and NO_x concentrations of approximately 80% of the URL, and an intermediate concentration.
5. Adjust the GPT system to generate a NO concentration near 90% of the URL of the instrument range selected.

6. Sample this NO concentration until the NO and NO_x responses have stabilized, then measure and record the NO concentration as [NO]_{ORIG}.
7. Adjust the O₃ generator in the GPT system to generate sufficient O₃ to produce a decrease in the NO concentration equivalent to about 80% of the URL of the NO₂ range. The decrease must not exceed 90% of the NO concentration determined in Steps 5 and 6 above.
8. When the analyzer responses stabilize, record the resultant NO concentrations as [NO]_{REM}.
9. From the Main Menu choose Calibration > **Cal NO2 Coefficient**.
The NO₂ line of the Calibrate NO₂ screen displays the current NO₂ concentration. The SPAN CONC line of the display is where you enter the NO₂ calibration gas concentration.
10. Set the NO₂ calibration gas concentration to reflect the sum of the following: the NO₂ concentration generated by GPT, ([NO]_{ORIG} - [NO]_{REM}), and any NO₂ impurity.

Use   to move the cursor left and right and use   to increment and decrement the numeric character at the cursor.

$$[\text{NO}_2]_{\text{OUT}} = ([\text{NO}]_{\text{ORIG}} - [\text{NO}]_{\text{REM}}) + \frac{F_{\text{NO}} \times [\text{NO}_2]_{\text{IMP}}}{F_{\text{NO}} + F_{\text{O}} + F_{\text{D}}}$$

Where:

[NO₂]_{OUT} = diluted NO₂ concentration at the output manifold, ppm

[NO]_{ORIG} = original NO concentration, prior to addition of O₃, ppm

[NO]_{REM} = NO concentration remaining after addition of O₃, ppm

11. Press  to calculate and save the new NO₂ coefficient based on the entered span concentration.

The analyzer does a one point NO₂ span coefficient calculation, corrects the NO₂ reading for converter inefficiency, and then adds the corrected NO₂ to the NO signal to give a corrected NO_x signal.

If the analyzer calculates a NO₂ span coefficient of less than 0.96, either the entered NO₂ concentration is incorrect, the converter is not being heated to the proper temperature, the instrument needs servicing (leak or imbalance), or the converter needs replacement or servicing. The

NO₂ analog output will reflect the NO₂ concentration generated by GPT, any NO₂ impurity, and the NO₂ zero offset.

The recorder response will be as follows:

$$\text{Recorder Response (\% scale)} = \frac{[\text{NO}_2]_{\text{OUT}}}{\text{URL}} \times 100 + Z_{\text{NO}_2}$$

Where:

URL = Nominal upper range limit of the NO₂ channel, ppm

12. Record the NO₂ concentration and the analyzer's NO₂ response.
13. Maintaining the same F_{NO}, F_O, and F_D, adjust the ozone generator to obtain several other concentrations of NO₂ over the NO₂ range (at least five evenly spaced points across the remaining scale are suggested).
14. Record the stable responses and plot the analyzer's NO₂ responses versus the corresponding calculated (using the above equation for [NO₂]_{OUT}) concentrations and draw or calculate the NO₂ calibration curve.

Note It is important that the curve be linear within ±1% FS over the NO₂ range. If the curve is nonlinear, the analyzer is not operating correctly, (possible leak, or converter failure, etc.), and should be serviced. Assuming the curve is linear, subsequent data should be reduced using this NO₂ calibration curve response. ▲

Using the Calibration Factors menu can change the calibration factors. This is often useful in a troubleshooting situation. However, after the above calibration procedure is completed, all subsequent data reduction depends on the calibration parameters, remaining the same as during the initial calibration. ▲

Therefore, never change any calibration factor without first recording the value so that after any troubleshooting procedure is completed, the initial value can be re-entered thereby not altering the multipoint calibration. ▲

Alternative Calibration Procedure Using NO₂ Permeation Tube

Although it is recommended that a GPT system be used to calibrate the analyzer, the procedure described in the Code of Federal Regulations, Title 40, Part 50, Appendix F using a NO₂ permeation tube may be used as an alternative procedure for calibrating the instrument.

Calibration in Dual Range and Auto Range Mode

The dual/auto range calibration feature is used to calibrate the analyzer at two different span levels (as opposed to a single span level in the standard mode) generating a “tailored multi-point” calibration curve stored in the analyzer's memory. This feature may be used:

- When widely different gas levels are being monitored, such as a factor of 10 or greater apart
- If precision and span levels are being introduced using separate tanks
- If more than one multi-component cylinder is being used to calibrate the instrument

Properly designed chemiluminescence analyzers are inherently linear over a wide dynamic range; and under normal USEPA compliance situations this feature is not required. Dual calibration may be used for span levels less than a factor of 10 apart, however if this is done to correct for a significant non-linearity, it may mask the problems causing the effect, such as, bad calibration cylinder, leaks in sampling lines, or low ozonator output.



Use the following procedures to calibrate the analyzer in dual or auto range mode.

Set NO and NO_x Background Readings to Zero

Use the following procedure to set the NO and NO_x background readings to zero. Both the Set NO background and NO_x background screens operate the same way, and the following procedure also applies to the NO and NO_x background screen.

For detailed information about the menu parameters and the icons used in these procedures, see the “[Operation](#)” chapter.

1. Follow the “Pre-Calibration” procedure described previously in this chapter.
2. Introduce zero air to the SAMPLE bulkhead and allow the analyzer to sample zero air until the NO, NO_x, and NO₂ responses stabilize.

3. When the responses stabilize, from the Main Menu choose Calibration > **Calibrate NO Background**.
4. The Set NO Background screen displays the current NO background and NO concentration.
5. Press  to set the NO background to zero.
6. Press  to return to the Run screen.
7. Repeat Steps 3 through 6, selecting **Cal NO_x Background** to set the NO_x backgrounds to zero.





Calibrate Low NO

Use the following procedure to calibrate NO channel to the NO calibration gas.

1. Disconnect the source of zero air from the SAMPLE bulkhead. In its place, connect a source of NO calibration gas of about 80% of the low NO full-scale range.
2. Allow the analyzer to sample the low NO calibration gas until the NO, NO₂, and NO_x readings stabilize.
3. When the responses are stable, from the Main Menu choose Calibration > **Cal Lo NO Coefficient**.

4. The Lo NO field displays the current NO concentration.

The Lo NO Span Conc field is where you enter the low NO calibration gas concentration.

Use   to move the cursor left and right and use   to increment and decrement the numeric character at the cursor.







5. Press  to calculate and save the new low NO coefficient based on the entered span concentration.

Calibrate Low NO_x

Use the following procedure to calibrate the NO_x channel to the NO_x calibration gas.





Calibration

Calibration in Dual Range and Auto Range Mode

1. Press  to return to the Calibration menu and choose Cal Lo NO_x Coefficient.
2. Verify that the low NO_x calibration gas concentration is the same as the low NO calibration gas concentration plus any known NO₂ impurity.
The Lo NO_x field displays the current NO_x concentration. The Lo NO_x Span Conc field is where you enter the low NO_x calibration gas concentration.
Use   to move the cursor left and right and use   to increment and decrement the numeric character at the cursor.
3. Press  to calculate and save the new low NO_x coefficient based on the entered span concentration.
4. Press  to return to the Run screen.

Calibrate Low NO₂

Use the following procedure to calibrate the NO₂ channel to the NO₂ calibration gas.





1. Adjust the O₃ generator in the GPT system to generate sufficient O₃ to produce a decrease in the low NO concentration equivalent to about 80% of the URL of the low NO₂ range. The decrease must not exceed 90% of the low NO concentration determined in the “Calibrate Low NO_x” procedure.
2. From the Main Menu choose Calibration > **Cal Lo NO₂ Coefficient**.
The Lo NO₂ field displays the current NO₂ concentration. The Lo NO₂ Span Conc field is where you enter the Lo NO₂ calibration gas concentration.
3. Set the low NO₂ calibration gas concentration to reflect the sum of the NO₂ concentration generated by GPT and any NO₂ impurity.
Use   to move the cursor left and right and use   to increment and decrement the numeric character at the cursor.
4. Press  to calculate and save the new low NO₂ coefficient based on the entered span concentration.

Calibrate High NO

Use the following procedure to calibrate the NO channel to the NO calibration gas.

1. Connect a source of high NO calibration gas of about 80% of the high NO full-scale range. Allow the analyzer to sample the high NO calibration gas until the NO, NO₂, and NO_x readings have stabilized.
2. After the responses have stabilized, from the Main Menu, choose Calibration > **Cal Hi NO Coefficient**.

The Hi NO field displays the current NO concentration. The Hi NO Span Conc field is where you enter the high NO calibration gas concentration.

Use   to move the cursor left and right and use   to increment and decrement the numeric character at the cursor.





3. Press  to calculate and save the new high NO coefficient based on the entered span concentration.



Calibrate High NO_x

Use the following procedure to calibrate the NO_x channel to the NO_x calibration gas.

1. Press  to return to the Calibration menu, and choose Cal Hi NO_x Coefficient.

2. Verify that the high NO_x calibration gas concentration is the same as the high NO calibration gas concentration plus any known NO₂ impurity.

Use   to move the cursor left and right and use   to increment and decrement the numeric character at the cursor.





3. Press  to calculate and save the new high NO_x coefficient based on the entered span concentration.
4. Press  to return to the Run screen.

Calibrate High NO₂

Use the following procedure to calibrate the NO₂ channel to the NO₂ calibration gas.

Calibration

Zero and Span Check

1. Adjust the O₃ generator in the GPT system to generate sufficient O₃ to produce a decrease in the high NO concentration equivalent to about 80% of the URL of the high NO₂ range. The decrease must not exceed 90% of the high NO concentration determined in the “Calibrate High NO_x” procedure.
2. From the Main Menu, choose Calibration > **Cal Hi NO₂ Coefficient**.
The Hi NO₂ field displays the current NO₂ concentration. The Hi NO₂ Span Conc field is where you enter the high NO₂ calibration gas concentration.
3. Set the high NO₂ calibration gas concentration to reflect the sum of the NO₂ concentration generated by GPT and any NO₂ impurity.
Use   to move the cursor left and right and use   to increment and decrement the numeric character at the cursor.
4. Press  to calculate and save the new high NO₂ coefficient based on the entered span concentration.

You can change the calibration factors by using the Calibration Factors menu. This is often useful in a troubleshooting situation. However, after the above calibration procedure is completed, all subsequent data reduction depends on the calibration parameters remaining the same as during the initial calibration.

Therefore never change any calibration factor without first recording the value so that after any troubleshooting procedure is completed, the initial value can be re-entered thereby not altering the multipoint calibration.

Zero and Span Check

The analyzer requires initial and periodic calibration according to the procedures outlined in this manual. Initially, the frequency of the calibration procedure should be determined by the stability of the zero and span checks, which may be run daily. You should generate a new calibration curve when zero and span checks indicate a shift in instrument gain of more than 10 percent from that determined during the most recent multipoint calibration. You can adjust the frequency of calibration and even zero and span checks appropriately as you gain confidence with the instrument.

You should have a quality control plan where the frequency and the number of points required for calibration can be modified on the basis of calibration and zero and span check data collected over a period of time. Note however, that the EPA requires a minimum of one multipoint calibration per calendar quarter. Such a quality control program is essential

to ascertain the accuracy and reliability of the air quality data collected and to alert the user if the accuracy or reliability of the data should become unacceptable. A compilation of this kind might include items such as dates of calibration, atmospheric conditions, calibration factors, and other pertinent data.

Use the following procedure to perform a zero and span check.

1. Connect the zero gas to the SAMPLE bulkhead in a standard instrument or to the ZERO bulkhead in a Model 42*i* equipped with the zero/span and sample solenoid valve option.
2. Allow the instrument to sample zero gas until a stable reading is obtained on the NO, NO₂, and NO_x channels then record the zero readings. Unless the zero has changed by more than ± 0.010 ppm, it is recommended that the zero not be adjusted. If an adjustment larger than this is indicated due to a change in zero reading, a new multipoint calibration curve should be generated.
3. Attach a supply of known concentration of NO and NO₂ (usually generated via an NIST traceable NO working standard and a GPT system) to the SAMPLE bulkhead (or SPAN bulkhead for instruments equipped with the zero/span and sample solenoid valve option) on the rear panel.
4. Allow the instrument to sample the calibration gas until a stable reading is obtained on the NO, NO₂, and NO_x channels. If the calibration has changed by more than $\pm 10\%$, a new multipoint calibration curve should be generated.
5. When the calibration check has been completed, record the NO, NO₂, and NO_x values.
6. Reconnect the analyzer sample line to the SAMPLE bulkhead.

Chapter 5

Preventive Maintenance

This chapter describes the periodic maintenance procedures that should be performed on the instrument to ensure proper operation. Since usage and environmental conditions vary greatly, you should inspect the components frequently until an appropriate maintenance schedule is determined.

This chapter includes the following maintenance information and replacement procedures:

- “Safety Precautions” on page 5-1
- “Replacement Parts” on page 5-2
- “Cleaning the Outside Case” on page 5-2
- “Ozonator Air Feed Drying Column Replacement” on page 5-2
- “Capillaries Inspection and Replacement” on page 5-2
- “Thermoelectric Cooler Fins Inspection and Cleaning” on page 5-4
- “Fan Filters Inspection and Cleaning” on page 5-4
- “Pump Rebuilding” on page 5-5

Safety Precautions

Read the safety precautions before beginning any procedures in this chapter.



WARNING If the equipment is operated in a manner not specified by the manufacturer, the protection provided by the equipment may be impaired. Do not attempt to lift the instrument by the cover or other external fittings. ▲



Equipment Damage Some internal components can be damaged by small amounts of static electricity. A properly ground antistatic wrist strap must be worn while handling any internal component. For more information about appropriate safety precautions, see the “Servicing” chapter. ▲

Replacement Parts

See the “[Servicing](#)” chapter for a list of replacement parts.

Cleaning the Outside Case

Clean the outside case using a damp cloth being careful not to damage the labels on the case.



Equipment Damage Do not use solvents or other cleaning products to clean the outside case. ▲

Ozonator Air Feed Drying Column Replacement

Use the following procedure to replace the ozonator air feed drying column.

1. Remove the drying column from the connector DRY AIR bulkhead on the rear panel of the instrument.
2. Replace spent absorbent material (indicating Drierite or silica gel) with new or regenerated material.
3. Reinstall the drying column to the DRY AIR bulkhead.
4. Perform a Zero/Span check (see the “[Calibration](#)” chapter).

Capillaries Inspection and Replacement

The capillaries normally only require inspection when instrument performance indicates that there may be a flow problem.



Equipment Damage Some internal components can be damaged by small amounts of static electricity. A properly ground antistatic wrist strap must be worn while handling any internal component. For more information about appropriate safety precautions, see the “[Servicing](#)” chapter. ▲

Use the following procedure to inspect and replace the capillaries. This procedure can be used to check any or all of the capillaries.

1. Turn the instrument OFF and unplug the power cord.
2. Remove the instrument cover.

3. Locate the capillary holders. See [Figure 5–1](#) and [Figure 7–2](#).

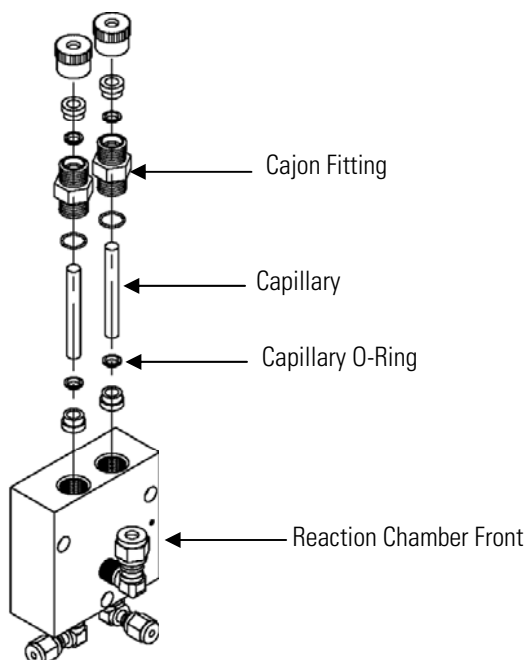

Figure 5–1. Inspecting and Replacing the Capillaries

4. Remove the Cajon® fitting(s) from the reaction chamber body using a 5/8-inch wrench being careful not to lose the ferrule or O-ring.
5. Remove the glass capillaries, ferrule, and O-ring. Inspect O-ring for cuts or abrasion, and replace as necessary.
6. Check capillary for particulate deposits. Clean or replace as necessary.
7. Replace capillary in reaction chamber body, making sure the O-ring is around the capillary before inserting it into the body.
8. Replace Cajon® fitting. Note that the Cajon® fitting should be tightened slightly more than hand tight.
9. Reconnect tubing to top of fittings, being careful to insert ferrule and O-ring properly, and tighten knurled nut finger tight.
10. Re-install the cover.

11. Connect the power cord and turn the instrument ON.

Thermoelectric Cooler Fins Inspection and Cleaning

Use the following procedure to inspect and clean the thermoelectric cooler fins.



Equipment Damage Some internal components can be damaged by small amounts of static electricity. A properly ground antistatic wrist strap must be worn while handling any internal component. For more information about appropriate safety precautions, see the “[Servicing](#)” chapter. ▲

1. Turn the instrument off and unplug the power cord.
2. Remove the instrument cover.
3. Locate the PMT cooler ([Figure 7–2](#) and [Figure 7–6](#)).
4. Blow off the cooler fins using clean pressurized air. It may be more convenient to vacuum the cooler fins. In either case, make sure that any particulate accumulation between the fins has been removed.
5. If necessary, use a small brush to remove residual particulate accumulation.
6. Replace the cover.
7. Connect the power cord and turn the instrument ON.

Fan Filters Inspection and Cleaning

Use the following procedure to inspect and clean the fan filters.

1. Remove the two fan guards from the fans and remove the filters.
2. Flush the filters with warm water and let dry (a clean, oil-free purge will help the drying process) or blow the filters clean with compressed air.
3. Re-install the filters and fan guards.

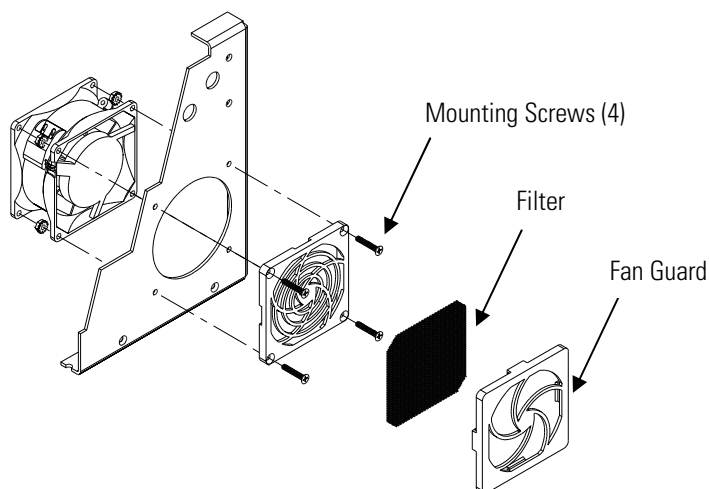

Figure 5–2. Inspecting and Cleaning the Fan Filters

Pump Rebuilding

Use the following procedure to rebuild the pump [Figure 5–3](#). To replace the pump, see “[Pump Replacement](#)” in the “[Servicing](#)” chapter.

Equipment Required:

- Pump Repair Kit
- Allen Wrench, 3 mm
- Wrench, 9/16-inch
- Needlenose Pliers



Equipment Damage Some internal components can be damaged by small amounts of static electricity. A properly ground antistatic wrist strap must be worn while handling any internal component. For more information about appropriate safety precautions, see the “[Servicing](#)” chapter. ▲

1. Turn instrument off, unplug the power cord, and remove the cover.
2. Loosen fittings and remove both lines going to the pump.
3. To ensure proper reassembly, mark the position of the pump head by using a pencil or other marker to draw a line from the top plate down across the bottom plate to the pump body. Refer to this reference line when reassembling the pump head.

Preventive Maintenance
Pump Rebuilding

4. Remove four screws from top plate using the 3 mm Allen wrench.
5. Remove top plate, flapper valve, and bottom plate.
6. Using needlenose pliers, remove clamping disk holding diaphragm and Teflon protection wafer onto clamping rod, and remove the diaphragm and Teflon wafer.

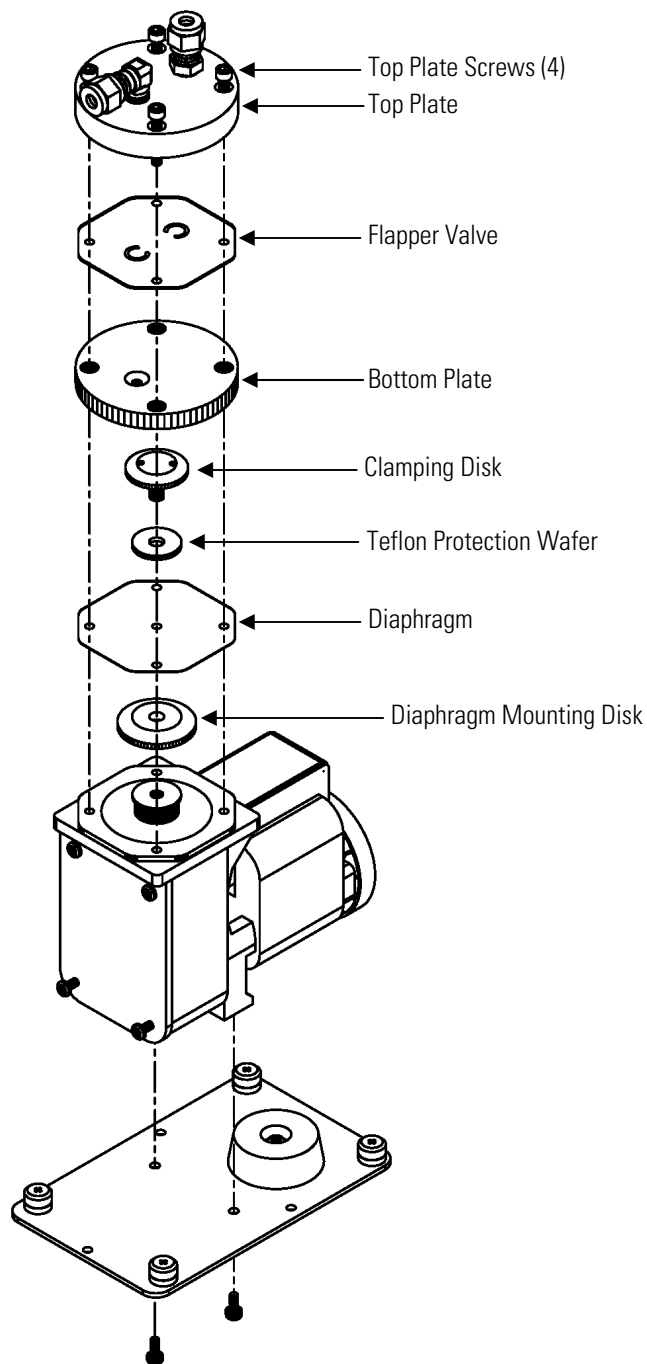

Figure 5–3. Rebuilding the Pump

7. Assemble pump by following above procedure in reverse. Refer to the marks you made in Step three to position the components. Make sure not to over-tighten clamping disk. Be sure that the Teflon side of diaphragm faces up and that the flapper valves cover the holes of the top and bottom plate.

Preventive Maintenance

Pump Rebuilding

8. Re-install the cover, reconnect the power cord, and turn the instrument ON.
9. Check that the reaction chamber pressure reads between 150 and 250 mmHg.

Chapter 6

Troubleshooting

This instrument has been designed to achieve a high level of reliability. In the event of problems or failure, the troubleshooting guidelines, board-level connection diagrams, connector pin descriptions, and testing procedures presented in this chapter should be helpful in isolating and identifying problems.

For additional fault location information refer to the “[Preventive Maintenance](#)” chapter in this manual.

The service mode in the “[Operation](#)” chapter includes parameters and functions that are useful when making adjustments or diagnosing problems.

The Technical Support Department at Thermo Fisher Scientific can also be consulted in the event of problems. See “[Service Locations](#)” on page 6-21 for contact information. In any correspondence with the factory, please note both the serial number and program number of the instrument.

This chapter provides the following troubleshooting and service support information:

- “[Safety Precautions](#)” on page 6-1
- “[Troubleshooting Guides](#)” on page 6-1
- “[Board-Level Connection Diagrams](#)” on page 6-6
- “[Connector Pin Descriptions](#)” on page 6-8
- “[Service Locations](#)” on page 6-21

Safety Precautions

Read the safety precautions in the Preface and “[Servicing](#)” chapter before performing any actions listed in this chapter.

Troubleshooting Guides

The troubleshooting guides presented in this chapter are designed to help isolate and identify instrument problems.

[Table 6–1](#) provides general troubleshooting information and indicates the checks that you should perform if you experience an instrument problem.

Table 6–2 lists all the alarm messages you may see on the graphics display and provides recommendations about how to resolve the alarm condition. See “Alarms Menu” in the “Operation” chapter for detailed information.

Table 6–1. Troubleshooting - General Guide

Malfunction	Possible Cause	Action
Does not start up	No power	Check that the instrument is plugged into the proper source (115 or 220 VAC, 50 or 60Hz). Check instrument fuses.
	Power Supply	Check voltages using a digital voltmeter.
No output signal (or very low output)	No sample gas reaching the analyzer	Check input sample flow.
	Ruptured pump diaphragm	Rebuild pump head.
	Blocked sample capillary	Unplug power cord. Clean or replace capillary.
	No ozone reaching the reaction chamber	Check the Instrument Control menu to see if the ozonator is ON. If it is ON, check dry air supply.
No output signal	Disconnected or defective input or high voltage supply	Unplug power cord. Check that cables are connected properly. Check cable resistance.
	Analyzer not calibrated	Recalibrate.
	Defective ± 15 volt	Check supply voltages (Diagnostics menu).
Calibration Drift	Dryer or ozonator depleted	Replace.
	Line voltage fluctuations	Check to see if line voltage is within specifications.
	Defective pump	Rebuild pump.
	Unstable NO or NO ₂ source	Replace.
	Clogged capillaries	Unplug power cord. Clean or replace capillary.
	Clogged sample air filter	Replace filter element.
Excessive Noise	Defective or low sensitivity PMT	Unplug power cord. Remove PMT. Install known good PMT. Plug in power cord. Check performance.
	Defective input board	Replace board.

Malfunction	Possible Cause	Action
	Defective cooler	Check temperature (less than -2 °C at T _{amb} = 25 °C).
Non-linear response	Incorrect calibration source	Verify accuracy of multipoint calibration source gas.
	Leak in sample probe line	Check for variable dilution.
Excessive response time	Partially blocked sample capillary	Unplug power cord. Clean or replace capillary.
	Hang up/blockage in sample filter	Change element.
Improper converter operation	Questionable calibration gas	Verify accuracy.
	Converter temperature too high or too low	Temperature should be approximately 325 °C for Molybdenum, 625 °C for stainless steel.
	Low line voltage	Check to see if line voltage is within specifications.
	Molybdenum consumed	Replace Molybdenum converter cartridge.

Table 6–2. Troubleshooting - Alarm Messages

Alarm Message	Possible Cause	Action
Alarm - Internal Temp	Check fan operation	Replace fan if not operating properly.
	Check fan filter	Clean or replace foam filter, refer to "Preventive Maintenance" chapter in this manual.
Alarm - Chamber Temp	Chamber temperature below set point of 50 °C	Check 10K ohm thermistor, replace if bad. Check temperature control board to insure the LEDs are coming on. If not, temperature control board could be defective.
Alarm - Cooler Temp Cooler reads 80 °C	Check fan operation	Replace defective fan.
	Check fan filter	Clean or replace foam filter.
	Bad cooler	Replace cooler.
	Cooler does not hold set point of -3 °C	Replace cooler – thermoelectric module inside cooler failed.
	Cooler reads -20 °C	Replace cooler – thermocouple bad.
Alarm - Conv. Temp	Converter temperature low	Molybdenum converter should be hot to the touch, if not the heater may have failed. Check that converter temp. set point is approximately 325 °C. Check that voltage to the heater is 115 VAC.
Alarm - Perm Gas Temp	Incorrect Perm oven set temperature or alarm settings	Check that the alarm settings match the set temp.
	Perm oven heater thermistor or gas thermistor is out of calibration	Calibrate the thermistor.
	Perm oven failure	Replace the Perm oven.
Alarm - Pressure	High pressure indication	Check the pump for a tear in the diaphragm, replace with pump repair kit if necessary. Refer to "Preventive Maintenance" chapter in this manual. Check that capillaries are properly installed and O-rings are in good shape.

Alarm Message	Possible Cause	Action
		Replace if necessary. Check flow system for leaks.
Alarm - Flow	Flow low	Check sample capillary (0.020 inch ID) for blockage. Replace as necessary. If using sample particulate filter make sure it is not blocked. Disconnect sample particulate filter from the sample bulkhead, if flow increases, replace the filter.
Alarm – Ozonator Flow	Ozone flow low	Check ozone capillary (0.008 inch ID) for blockage. Replace as necessary.
Alarm - Zero Check Alarm - Span Check	Instrument out of calibration	Recalibrate instrument.
Alarm - Zero Autocal Alarm - Span Autocal		Check gas supply. Perform manual calibration.
Alarm – NO, NO ₂ , NO _x Conc.	Concentration has exceeded range limit	Check to insure range corresponds with expected value. If not select proper range.
	Concentration low	Check user-defined low set point, set to zero.
Alarm - Motherboard Status	Internal cables not connected properly	Check that all internal cables are connected properly.
Alarm - Interface Status	Board is defective	Recycle AC power to instrument. If still alarming, change board.
Alarm - I/O Exp Status		

Board-Level Connection Diagrams

Figure 6–1 and Figure 6–2 are board-level connection diagrams for the common electronics and measurement system. These illustrations can be used along with the connector pin descriptions in Table 6–3 through Table 6–9 to troubleshoot board-level faults.

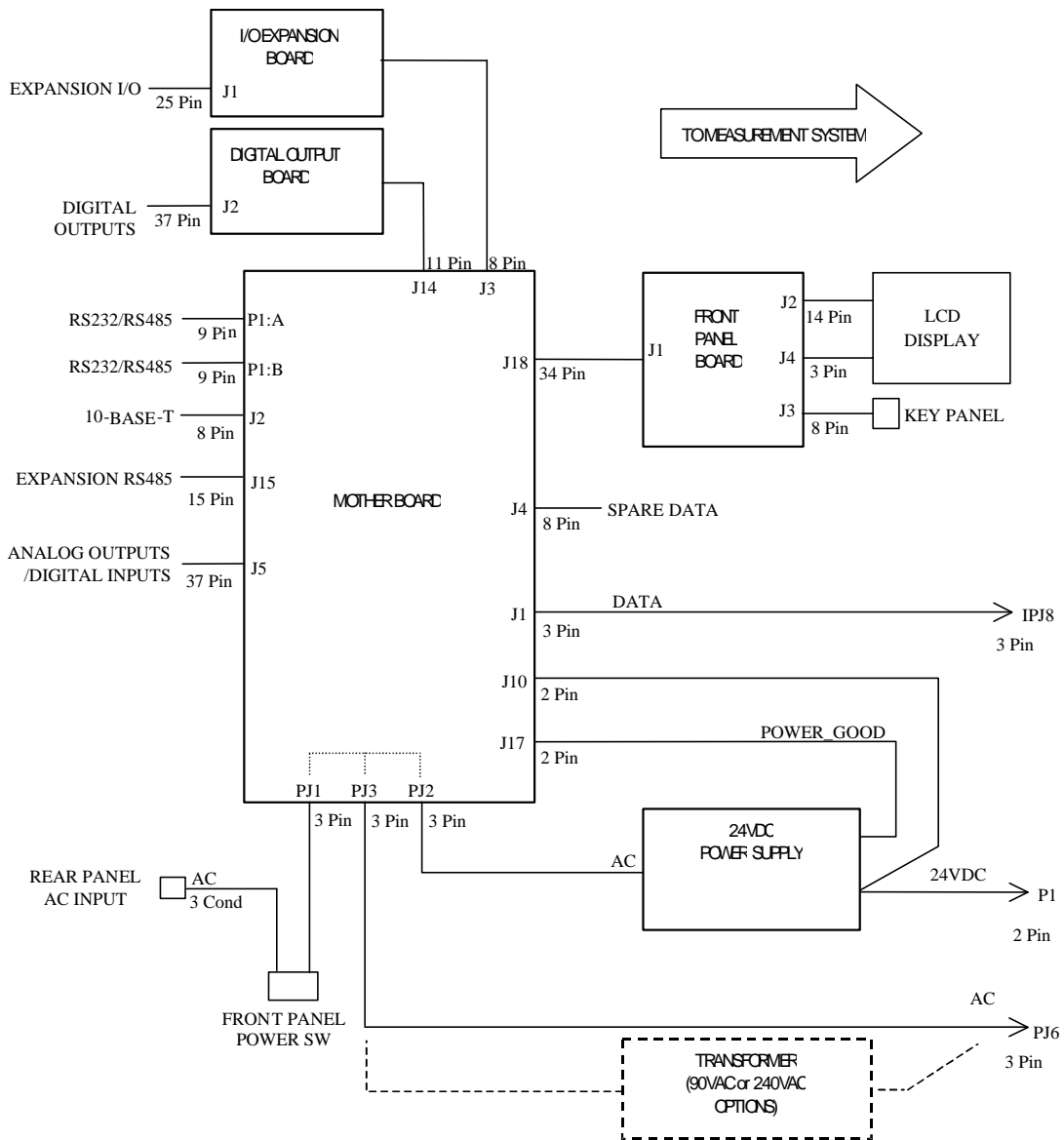

Figure 6–1. Board-Level Connection Diagram - Common Electronics

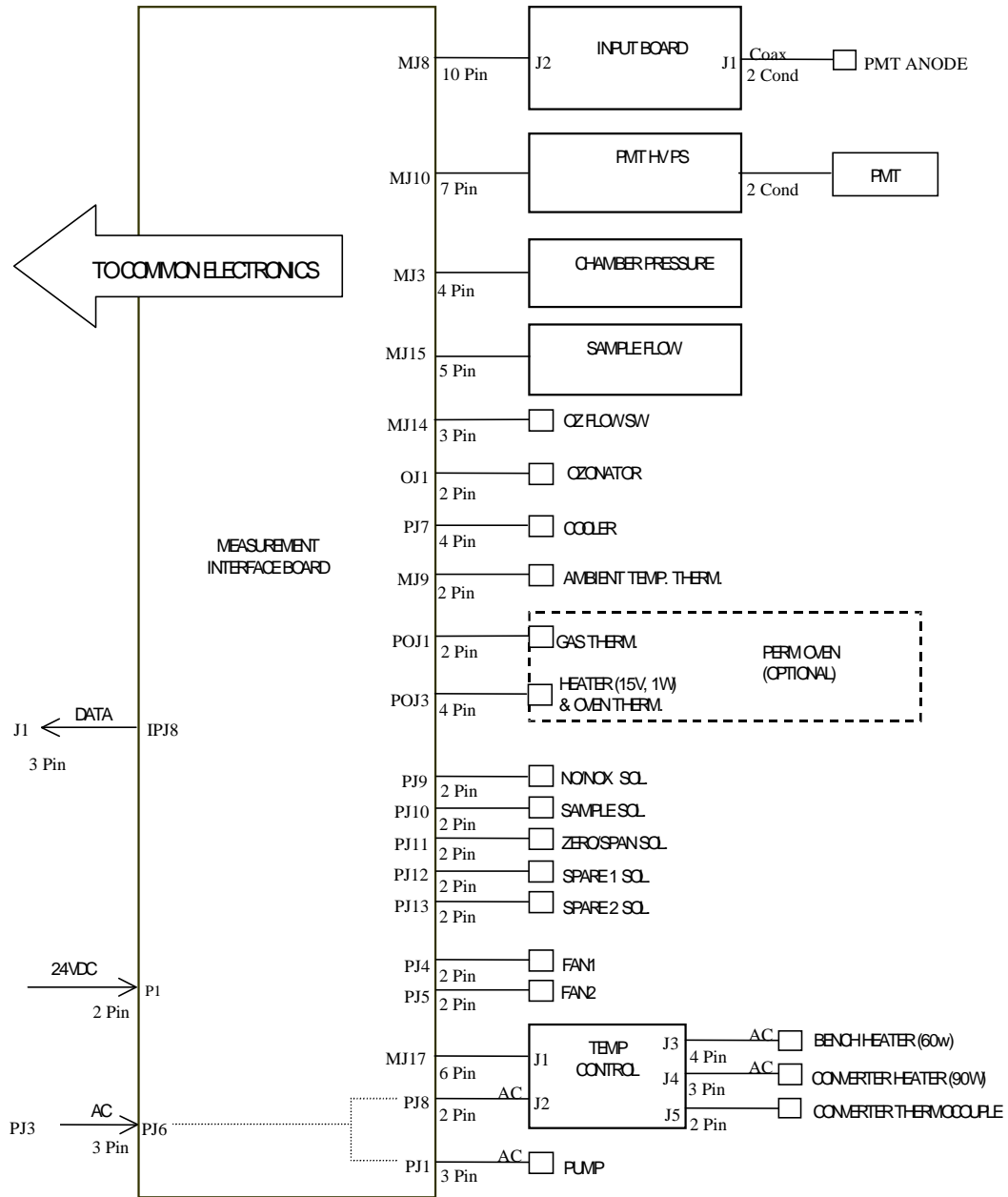

Figure 6–2. Board-Level Connection Diagram - Measurement System

Connector Pin Descriptions

The connector pin descriptions in Table 6–3 through Table 6–9 can be used along with the board-level connection diagrams to troubleshoot board-level faults.

“Motherboard Connector Pin Descriptions” on page 6-8

“Measurement Interface Board Connector Pin Descriptions” on page 6-13

“Front Panel Board Connector Pin Diagram” on page 6-15

“I/O Expansion Board (Optional) Connector Pin Descriptions” on page 6-17

“Digital Output Board Connector Pin Descriptions” on page 6-18

“Input Board Connector Pin Descriptions” on page 6-20

“Temperature Control Board Connector Pin Descriptions” on page 6-20

Table 6–3. Motherboard Connector Pin Descriptions

Connector Label	Reference Designator	Pin	Signal Description
INTF DATA	J1	1	Ground
		2	+RS485 to Interface Board
		3	-RS485 to Interface Board
10-BASE-T	J2	1	Ethernet Output (+)
		2	Ethernet Output (-)
		3	Ethernet Input (+)
		4	NC
		5	NC
		6	Ethernet Input (-)
		7	NC
		8	NC
EXPANSION BD	J3	1	+5V
		2	+24V
		3	+24V
		4	Ground
		5	Ground
		6	Ground
		7	+RS485 to Expansion Board

Connector Label	Reference Designator	Pin	Signal Description
		8	-RS485 to Expansion Board
SPARE DATA	J4	1	+5V
		2	+24V
		3	+24V
		4	Ground
		5	Ground
		6	Ground
		7	+RS485 to Spare Board
		8	-RS485 to Spare Board
I/O	J5	1	Power Fail Relay N.C. Contact
		2	Ground
		3	TTL Input 1
		4	TTL Input 2
		5	Ground
		6	TTL Input 5
		7	TTL Input 7
		8	TTL Input 8
		9	TTL Input 10
		10	Ground
		11	TTL Input 13
		12	TTL Input 15
		13	Ground
		14	Analog Voltage 1
		15	Analog Voltage 3
		16	Ground
		17	Analog Voltage 5
		18	Ground
		19	Ground
		20	Power Fail Relay COM
		21	Power Fail Relay N.O. Contact
		22	Ground
		23	TTL Input 3
		24	TTL Input 4
		25	TTL Input 6

Troubleshooting

Connector Pin Descriptions

Connector Label	Reference Designator	Pin	Signal Description
		26	Ground
		27	TTL Input 9
		28	TTL Input 11
		29	TTL Input 12
		30	TTL Input 14
		31	TTL Input 16
		32	Ground
		33	Analog Voltage 2
		34	Analog Voltage 4
		35	Ground
		36	Analog Voltage 6
		37	Ground
SER EN	J7	1	Serial Enable Jumper
		2	+3.3V
24V IN	J10	1	+24V
		2	Ground
DIGITAL I/O	J14	1	+5V
		2	+24V
		3	+24V
		4	Ground
		5	Ground
		6	Ground
		7	SPI Reset
		8	SPI Input
		9	SPI Output
		10	SPI Board Select
		11	SPI Clock
EXT. RS485	J15	1	-RS485 to Rear Panel
		2	-RS485 to Rear Panel
		3	+5V
		4	+5V
		5	+5V
		6	Ground
		7	Ground

Connector Label	Reference Designator	Pin	Signal Description
		8	Ground
		9	NC
		10	NC
		11	+24
		12	+24
		13	+24
		14	+24
		15	+24
24 MONITOR	J17	1	24V Power Monitor
		2	Ground
FRONT PANEL BD	J18	1	Ground
		2	Ground
		3	LCLK – LCD Signal
		4	Ground
		5	Ground
		6	LLP – LCD Signal
		7	LFLM – LCD Signal
		8	LD4 – LCD Signal
		9	LD0 – LCD Signal
		10	LD5 – LCD Signal
		11	LD1 – LCD Signal
		12	LD6 – LCD Signal
		13	LD2 – LCD Signal
		14	LD7 – LCD Signal
		15	LD3 – LCD Signal
		16	LCD Bias Voltage
		17	+5V
		18	Ground
		19	Ground
		20	LCD_ONOFF – LCD Signal
		21	Keypad Row 2 Input
		22	Keypad Row 1 Input
		23	Keypad Row 4 Input

Troubleshooting

Connector Pin Descriptions

Connector Label	Reference Designator	Pin	Signal Description
		24	Keypad Row 3 Input
		25	Keypad Col 2 Select
		26	Keypad Col 1 Select
		27	Keypad Col 4 Select
		28	Keypad Col 3 Select
		29	Ground
		30	Ground
		31	Ground
		32	Ground
		33	+24V
		34	+24V
RS232/RS485:A	P1:A	1	NC
		2	Serial Port 1 RX (-RS485 IN)
		3	Serial Port 1 TX (-RS485 OUT)
		4	NC
		5	Ground
		6	NC
		7	Serial Port 1 RTS (+RS485 OUT)
		8	Serial Port 1 CTS (+RS485 IN)
		9	NC
RS232/RS485:B	P1:B	1	NC
		2	Serial Port 2 RX (-RS485 IN)
		3	Serial Port 2 TX (-RS485 OUT)
		4	NC
		5	Ground
		6	NC
		7	Serial Port 2 RTS (+RS485 OUT)
		8	Serial Port 2 CTS (+RS485 IN)
		9	NC
AC IN	PJ1	1	AC-HOT
		2	AC-NEUT
		3	AC-Ground
AC 24VPWR	PJ2	1	AC-HOT
		2	AC-NEUT

Connector Label	Reference Designator	Pin	Signal Description
AC INTF BD	PJ3	3	AC-Ground
		1	AC-HOT
		2	AC-NEUT
		3	AC-Ground

Table 6–4. Measurement Interface Board Connector Pin Descriptions

Connector Label	Reference Designator	Pin	Signal Description
DATA	IPJ8	1	Ground
		2	+RS485 from Motherboard
		3	-RS485 from Motherboard
PRES	MJ3	1	Pressure Sensor Input
		2	Ground
		3	+15V
		4	-15V
INPUT BD	MJ8	1	+15V
		2	Ground
		3	-15V
		4	+5V
		5	Ground
		6	Measurement Frequency Output
		7	Amplifier Zero Adjust Voltage
		8	SPI Output
		9	SPI Clock
		10	SPI Board Select
AMB TEMP	MJ9	1	Ambient Temperature Thermistor
		2	Ground
HVPS	MJ10	1	HV Power Supply Voltage Adjust
		2	Ground
		3	HV Power Supply On/Off
		4	Ground
		5	HV Power Supply Voltage Monitor
		6	Ground

Troubleshooting

Connector Pin Descriptions

Connector Label	Reference Designator	Pin	Signal Description
		7	Ground
FLOW SW	MJ14	1	NC
		2	Ground
		3	Ozonator Flow OK Switch
FLOW	MJ15	1	Flow Sensor Input
		2	Ground
		3	+15V
		4	-15V
		5	Ground
TEMP CTRL	MJ17	1	Bench Temperature Input
		2	Ground
		3	-15V
		4	Converter Heater On/Off
		5	Converter Temperature Input
		6	+15V_PWR
OZONATOR	OJ1	1	Ozonator Output A
		2	Ozonator Output B
24V IN	P1	1	+24V
		2	Ground
AC PUMP	PJ1	1	AC-HOT
		2	AC-NEUT
		3	AC-Ground
FAN 1	PJ4	1	+24V
		2	Ground
FAN 2	PJ5	1	+24V
		2	Ground
AC IN	PJ6	1	AC-HOT
		2	AC-NEUT
		3	AC-Ground
COOLER	PJ7	1	Cooler Thermistor
		2	Ground
		3	+15V_PWR
		4	Cooler On/Off Control
AC TEMP	PJ8	1	AC-HOT

Connector Label	Reference Designator	Pin	Signal Description
		2	AC-NEUT
		3	AC-Ground
NO/NOX SOL.	PJ9	1	+24V
		2	NO/NOX Solenoid Control
SAMPLE SOL.	PJ10	1	+24V
		2	Sample Solenoid Control
Z/S SOL.	PJ11	1	+24V
		2	Zero/Span Solenoid Control
SPARE1 SOL.	PJ12	1	+24V
		2	Spare 1 Solenoid Control
SPARE2 SOL.	PJ13	1	+24V
		2	Spare 2 Solenoid Control
PERM OVEN THERM	POJ1	1	Perm Oven Gas Thermistor
		2	Ground
PERM OVEN	POJ3	1	Perm Oven Heater On/Off
		2	+15V_PWR
		3	Perm Oven Thermistor
		4	Ground

Table 6–5. Front Panel Board Connector Pin Diagram

Connector Label	Reference Designator	Pin	Signal Description
MOTHER BOARD	J1	1	Ground
		2	Ground
		3	LCLK – LCD Signal
		4	Ground
		5	Ground
		6	LLP – LCD Signal
		7	LFLM – LCD Signal
		8	LD4 – LCD Signal
		9	LD0 – LCD Signal
		10	LD5 – LCD Signal
		11	LD1 – LCD Signal

Troubleshooting

Connector Pin Descriptions

Connector Label	Reference Designator	Pin	Signal Description
		12	LD6 – LCD Signal
		13	LD2 – LCD Signal
		14	LD7 – LCD Signal
		15	LD3 – LCD Signal
		16	LCD Bias Voltage
		17	+5V
		18	Ground
		19	Ground
		20	LCD_ONOFF – LCD Signal
		21	Keypad Row 2 Input
		22	Keypad Row 1 Input
		23	Keypad Row 4 Input
		24	Keypad Row 3 Input
		25	Keypad Col 2 Select
		26	Keypad Col 1 Select
		27	Keypad Col 4 Select
		28	Keypad Col 3 Select
		29	Ground
		30	Ground
		31	Ground
		32	Ground
		33	+24V
		34	+24V
LCD DATA	J2	1	LD0_5V – LCD Signal
		2	LD1_5V – LCD Signal
		3	LD2_5V – LCD Signal
		4	LD3_ONOFF_5V – LCD Signal
		5	LCD_ONOFF_5V – LCD Signal
		6	LFLM_5V – LCD Signal
		7	NC
		8	LLP_5V – LCD Signal
		9	LCLK_5V – LCD Signal
		10	+5V
		11	Ground

Connector Label	Reference Designator	Pin	Signal Description
		12	-25V
		13	LCD Bias Voltage
		14	Ground
KEYBOARD	J3	1	Keypad Row 1 Input
		2	Keypad Row 2 Input
		3	Keypad Row 3 Input
		4	Keypad Row 4 Input
		5	Keypad Col 1 Select
		6	Keypad Col 2 Select
		7	Keypad Col 3 Select
		8	Keypad Col 4 Select
LCD BACKLIGHT	J4	1	+5V Supply
		2	NC
		3	Ground

Table 6–6. I/O Expansion Board (Optional) Connector Pin Descriptions

Connector Label	Reference Designator	Pin	Signal Description
EXPANSION I/O	J1	1	Analog Voltage Input 1
		2	Analog Voltage Input 2
		3	Analog Voltage Input 3
		4	Ground
		5	Analog Voltage Input 4
		6	Analog Voltage Input 5
		7	Analog Voltage Input 6
		8	Ground
		9	Analog Voltage Input 7
		10	Analog Voltage Input 8
		11	Ground
		12	NC
		13	Current Output Return
		14	Ground
		15	Current Output 1

Troubleshooting

Connector Pin Descriptions

Connector Label	Reference Designator	Pin	Signal Description
		16	Current Output Return
		17	Current Output 2
		18	Current Output Return
		19	Current Output 3
		20	Current Output Return
		21	Current Output 4
		22	Current Output Return
		23	Current Output 5
		24	Current Output Return
		25	Current Output 6
MOTHER BD	J2	1	+5V
		2	+24V
		3	+24V
		4	Ground
		5	Ground
		6	Ground
		7	+RS485 to Motherboard
		8	-RS485 to Motherboard

Table 6–7. Digital Output Board Connector Pin Descriptions

Connector Label	Reference Designator	Pin	Signal Description
MOTHER BD	J1	1	+5V
		2	+24V
		3	+24V
		4	Ground
		5	Ground
		6	Ground
		7	SPI Reset
		8	SPI Input
		9	SPI Output
		10	SPI Board Select
		11	SPI Clock

Connector Label	Reference Designator	Pin	Signal Description
DIGITAL OUTPUTS	J2	1	Relay 1 Contact a
		2	Relay 2 Contact a
		3	Relay 3 Contact a
		4	Relay 4 Contact a
		5	Relay 5 Contact a
		6	Relay 6 Contact a
		7	Relay 7 Contact a
		8	Relay 8 Contact a
		9	Relay 9 Contact a
		10	Relay 10 Contact a
		11	NC
		12	Solenoid Drive Output 1
		13	Solenoid Drive Output 2
		14	Solenoid Drive Output 3
		15	Solenoid Drive Output 4
		16	Solenoid Drive Output 5
		17	Solenoid Drive Output 6
		18	Solenoid Drive Output 7
		19	Solenoid Drive Output 8
		20	Relay 1 Contact b
		21	Relay 2 Contact b
		22	Relay 3 Contact b
		23	Relay 4 Contact b
		24	Relay 5 Contact b
		25	Relay 6 Contact b
		26	Relay 7 Contact b
		27	Relay 8 Contact b
		28	Relay 9 Contact b
		29	Relay 10 Contact b
		30	+24V
		31	+24V
		32	+24V
		33	+24V

Troubleshooting

Connector Pin Descriptions

Connector Label	Reference Designator	Pin	Signal Description
		34	+24V
		35	+24V
		36	+24V
		37	+24V

Table 6–8. Input Board Connector Pin Descriptions

Connector Label	Reference Designator	Pin	Signal Description
PMT IN	J1	1	PMT Input
		2	Ground
INTF BD	J2	1	+15V
		2	Ground
		3	-15V
		4	+5V
		5	Ground
		6	Measurement Frequency Output
		7	Amplifier Zero Adjust Voltage
		8	SPI Input
		9	SPI Clock
		10	SPI Board Select

Table 6–9. Temperature Control Board Connector Pin Descriptions

Connector Label	Reference Designator	Pin	Signal Description
INTERFACE	J1	1	Bench Temperature Input
		2	Ground
		3	-15V
		4	Converter Heater On/Off
		5	Converter Temperature Input
		6	+15V_PWR
AC INPUT	J2	1	AC-HOT
		2	AC-NEUT
BENCH	J3	1	Bench Heater AC Output

Connector Label	Reference Designator	Pin	Signal Description
		2	Bench Heater AC Return
		3	Ground
		4	Bench Thermistor
CONVERTER	J4	1	Ground
		2	Converter Heater AC Output
		3	Converter Heater AC Return
CONV TC	J5	1	Converter Thermocouple TC
		2	Converter Thermocouple TC+
SS TEMP	J6	1	SS Temperature Range Jumper A
		2	SS Temperature Range Jumper B

Service Locations

For additional assistance, service is available from exclusive distributors worldwide. Contact one of the phone numbers below for product support and technical information or visit us on the web at www.thermo.com/aqi.

1-866-282-0430 Toll Free

1-508-520-0430 International

Chapter 7

Servicing

This chapter explains how to replace the Model 42*i* subassemblies. It assumes that a subassembly has been identified as defective and needs to be replaced.

For fault location information refer to the “[Preventive Maintenance](#)” chapter and the “[Troubleshooting](#)” chapter in this manual.

The service mode in the “[Operation](#)” chapter also includes parameters and functions that are useful when making adjustments or diagnosing problems.

For additional service assistance, see “[Service Locations](#)” at the end of this chapter.

This chapter includes the following parts information and component replacement procedures:

- “[Safety Precautions](#)” on page 7-2
- “[Firmware Updates](#)” on page 7-4
- “[Accessing the Service Mode](#)” on page 7-4
- “[Replacement Parts List](#)” on page 7-4
- “[Cable List](#)” on page 7-6
- “[External Device Connection Components](#)” on page 7-6
- “[Removing the Measurement Bench and Lowering the Partition Panel](#)” on page 7-8
- “[Pump Replacement](#)” on page 7-9
- “[Fan/Filter Replacement](#)” on page 7-10
- “[PMT Cooler and Reaction Chamber Assembly Replacement](#)” on page 7-11
- “[Photomultiplier Tube Replacement](#)” on page 7-13
- “[PMT High Voltage Power Supply Replacement](#)” on page 7-14
- “[PMT Voltage Adjustment](#)” on page 7-16
- “[Reaction Chamber Cleaning or Removal](#)” on page 7-17

- “NO₂-to-NO Converter Replacement” on page 7-18
- “Solenoid Valve Replacement” on page 7-20
- “Ozonator Assembly Replacement” on page 7-21
- “Ozonator Transformer Replacement” on page 7-23
- “Input Board Replacement” on page 7-23
- “Input Board Calibration” on page 7-25
- “DC Power Supply Replacement” on page 7-25
- “Analog Output Testing” on page 7-26
- “Analog Output Calibration” on page 7-29
- “Analog Input Calibration” on page 7-30
- “Pressure Transducer Assembly Replacement” on page 7-31
- “Pressure Transducer Calibration” on page 7-32
- “Temperature Control Board Replacement” on page 7-34
- “Ambient Temperature Calibration” on page 7-35
- “Fuse Replacement” on page 7-36
- “Scrubber Replacement” on page 7-36
- “I/O Expansion Board (Optional) Replacement” on page 7-37
- “Digital Output Board Replacement” on page 7-39
- “Motherboard Replacement” on page 7-39
- “Measurement Interface Board Replacement” on page 7-40
- “Flow Transducer Replacement” on page 7-41
- “Flow Transducer Calibration” on page 7-42
- “Front Panel Board Replacement” on page 7-44
- “LCD Module Replacement” on page 7-45
- “Service Locations” on page 7-46

Safety Precautions

Read the safety precautions before beginning any procedures in this chapter.



WARNING The service procedures in this manual are restricted to qualified service representatives. ▲

If the equipment is operated in a manner not specified by the manufacturer, the protection provided by the equipment may be impaired. ▲



CAUTION Carefully observe the instructions in each procedure. Avoid contact with converter heated components. ▲

Allow converter to cool to room temperature before handling converter components. ▲



Equipment Damage Some internal components can be damaged by small amounts of static electricity. A properly ground antistatic wrist strap must be worn while handling any internal component (Figure 7-1). If an antistatic wrist strap is not available, be sure to touch the instrument chassis before touching any internal components. When the instrument is unplugged, the chassis is not at earth ground. ▲

Handle all printed circuit boards by the edges. ▲

Do not point the photomultiplier tube at a light source. This can permanently damage the tube. ▲

Do not remove the LCD panel or frame from the LCD module. ▲

The LCD polarizing plate is very fragile, handle it carefully. ▲

Do not wipe the LCD polarizing plate with a dry cloth, it may easily scratch the plate. ▲

Do not use alcohol, acetone, MEK or other Ketone based or aromatic solvents to clean the LCD module, use a soft cloth moistened with a naphtha cleaning solvent. ▲

Do not place the LCD module near organic solvents or corrosive gases. ▲

Do not shake or jolt the LCD module. ▲

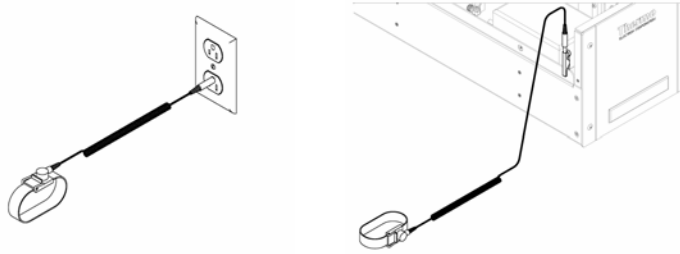





Figure 7-1. Properly Grounded Antistatic Wrist Strap

Firmware Updates

The firmware can be updated by the user in the field via the serial port or over the Ethernet. This includes both the main processor firmware and the firmware in all low-level processors. Refer to the *iPort* manual for the firmware update procedure.

Accessing the Service Mode

If the Service Menu is not displayed on the Main Menu, use the following procedure to display it.

1. From the Main Menu, choose Instrument Controls > **Service Mode**.
The Service Mode screen appears.
2. Press  to toggle the Service Mode to ON.
3. Press  >  to return to the Main Menu.
4. Return to the procedure.

Replacement Parts List

Table 7-1 lists the replacement parts for the Model 42*i* major subassemblies. Refer to Figure 7-2 to identify the component location.

Table 7-1. Model 42*i* Replacement Parts

Part Number	Description
100480-00	Front Panel Pushbutton Board
101491-01	Processor Board
100533-00	Motherboard
100539-00	Digital Output Board
100542-00	I/O Expansion Board (Optional)
102340-00	Front Panel Connector Board

Part Number	Description
102496-00	Front Panel Display
101399-00	Transformer, 220-240VAC (Optional)
101863-00	Transformer, 100VAC (Optional)
100536-01	Measurement Interface Board
100856-00	Temperature Control Board (Molybdenum Converter)
100856-01	Temperature Control Board (Stainless Steel Converter)
101167-00	Input Board Assembly
9973	Ozonator Assembly
101419-00	Ozonator Transformer
101023-00	Pressure Transducer
101021-00	Flow Transducer (Sample)
101620-00	Flow Switch (Ozone)
9367	Photomultiplier Tube (PMT)
101024-00	PMT High Voltage Power Supply
101324-00	PMT Base Socket Assembly
101390-00	Solenoid Valve
101020-00	Cooler Assembly
101008-01	Reaction Chamber Assembly
101009-00	NO ₂ -to-NO Converter Assembly (Molybdenum 110VAC)
101214-00	NO ₂ -to-NO Converter Assembly (Stainless Steel 110VAC)
9269	Molybdenum Converter Cartridge
9467	Stainless Steel Converter Cartridge
101011-00	Pump 100VAC w/Plate and Fittings
107751-00	Pump Repair Kit (new technology pump)
9267	Pump Repair Kit
101055-00	AC Receptacle Assembly
101681-00	Power Supply Assembly, 24VDC, w/Base Plate and Screws
100907-00	Fan, 24VDC
8630	Fan Filter
101905-00	Fuse, 250VAC, 4.0 Amp, SlowBlow (for 100VAC and 110VAC models)
101904-00	Fuse, 250VAC, 2.0 Amp, SlowBlow (for 220-240VAC models)
101688-00	Ambient Temperature Connector with Thermistor
4119	Capillary 0.008-inch ID
4127	Capillary 0.015-inch ID

Part Number	Description
6556	Optical Filter Kit (Red Filter, Quartz Window, Rubber Washer)
6998	DriRite

Cable List

Table 7–2 describes the Model 42*i* spare cables. See the “[Troubleshooting](#)” chapter for associated connection diagrams and board connector pin descriptions.

Table 7–2. Model 42*i* Cables

Part Number	Description
101036-00	DC Power Supply 24V Output
101037-00	115VAC Supply to Interface Board
101048-00	RS-485/Data
101038-00	AC Power Switch to Motherboard
101364-00	DC Power Supply Status Monitor
101054-00	Motherboard to Front Panel Board
101035-00	DC Power Supply AC Input
101033-00	AC from Receptacle
101377-00	AC to Power Switch
101267-00	Fan Power Cable
101346-00	Temperature Control
101355-02	Signal Output Ribbon
101695-00	Permeation Oven
101050-00	Heater Power
101055-00	Main AC Receptacle Assembly
102057-00	AC to External Pump

External Device Connection Components

Table 7–3 lists the standard and optional cables and components used for connecting external devices such as PCs and data loggers to an *i*Series instrument.

Table 7–3. External Device Connection Components

Part Number	Description
102562-00	Terminal Block and Cable Kit (DB25) (optional)
102556-00	Terminal Block and Cable Kit (DB37) (optional)
102645-00	Cable, DB37M to Open End Cable, Six Feet (optional)

Part Number	Description
102646-00	Cable, DB37F to Open End, Six Feet (optional)
102659-00	Cable, DB25M to Open End, Six Feet (optional)
6279	Cable, RS-232, Six Feet (optional)
102888-00	Terminal Board PCB Assembly, DB37F (standard)
102891-00	Terminal Board PCB Assembly, DB37M (standard)
103084-00	Terminal Board PCB Assembly, DB25M (included with optional I/O Expansion Board)

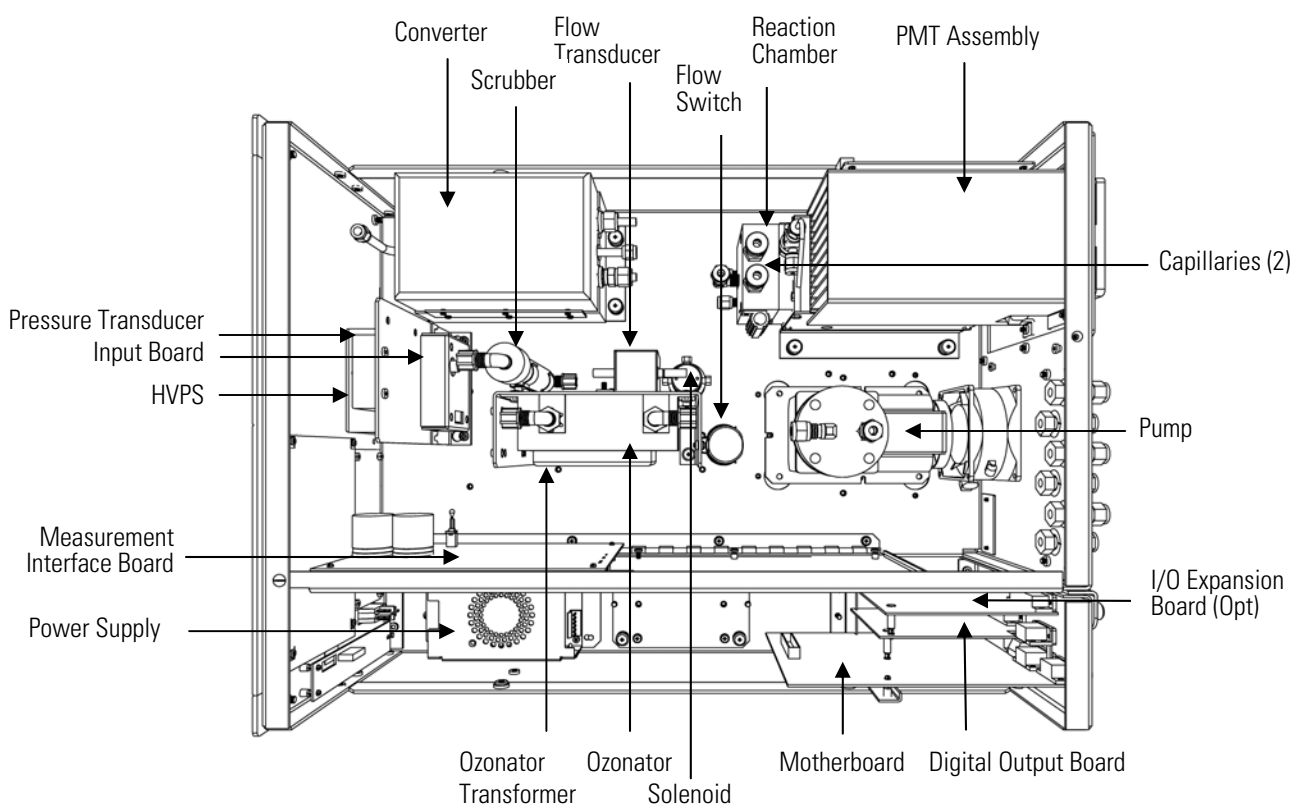

Figure 7–2. Component Layout

Servicing

Removing the Measurement Bench and Lowering the Partition Panel

Removing the Measurement Bench and Lowering the Partition Panel

The measurement bench can be removed and the partition panel can be lowered to improve access to connectors and components. Refer to the following steps when a procedure requires lowering the partition panel (see [Figure 7-3](#)).

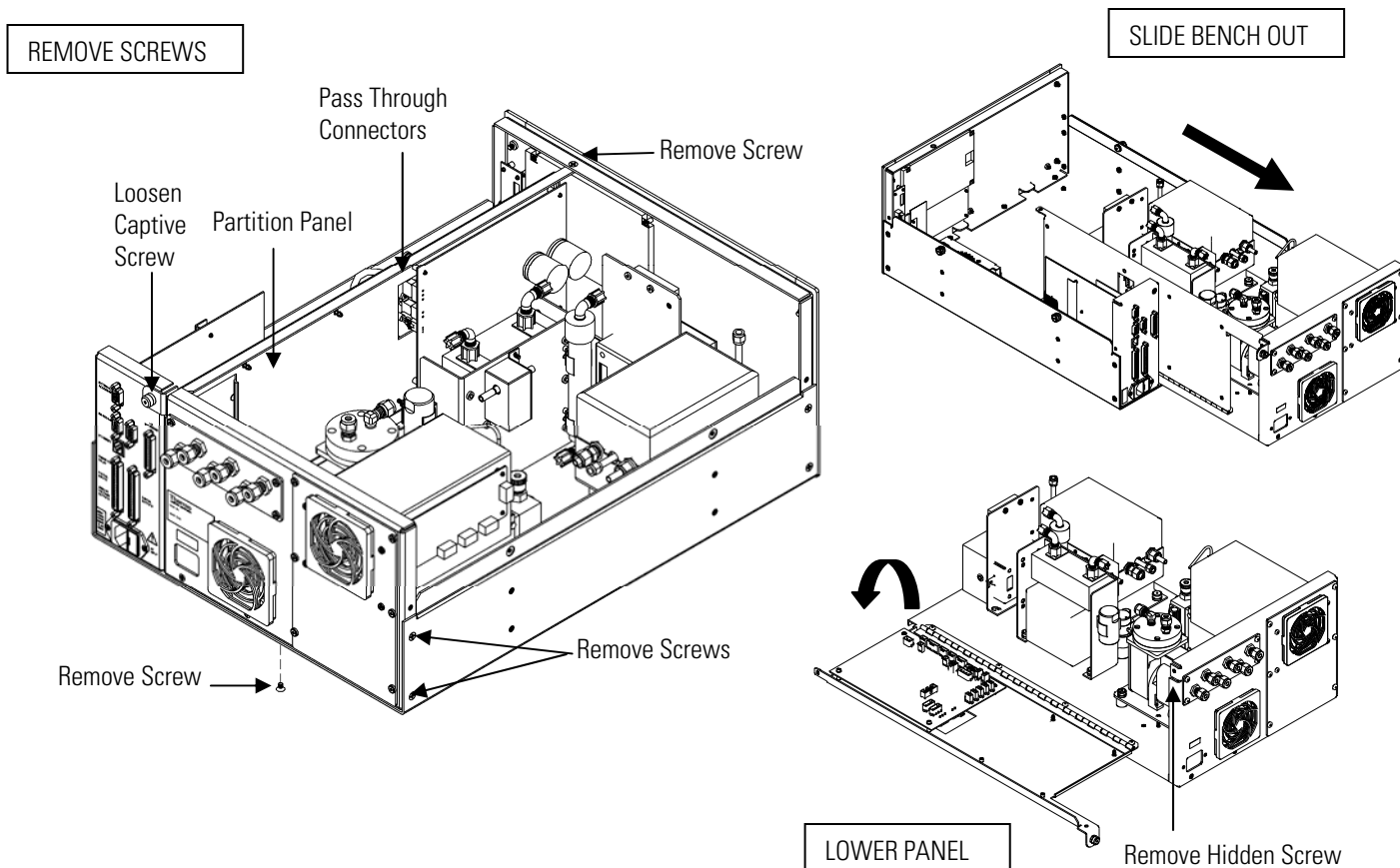

Figure 7-3. Removing the Measurement Bench and Lowering the Partition Panel

Equipment Required:

Philips screwdriver



Equipment Damage Some internal components can be damaged by small amounts of static electricity. A properly ground antistatic wrist strap must be worn while handling any internal component. ▲

1. Turn instrument OFF and unplug the power cord.

2. If the instrument is mounted in a rack, remove it from the rack.
3. Remove the cover.
4. Disconnect the plumbing connections at the rear of the measurement bench.
5. Disconnect the three connectors that pass through the center of the partition panel.
6. Remove two screws from the left side of the case (viewed from front).
7. Remove one screw from the bottom front of the case.
8. Remove one screw from the top front of the partition panel.
9. While holding the case securely, loosen the captive screw at the rear of the measurement bench, and pull the measurement bench from the rear of the case.
10. Remove the screw at the top rear of the partition panel securing the top of partition panel to the measurement bench, and lower the panel being careful not to put excessive tension on the cables.
11. Replace the measurement bench by following previous steps in reverse.

Pump Replacement

Use the following procedure to replace the pump (see [Figure 7-4](#)). To rebuild the pump, see “[Pump Rebuilding](#)” in the “[Preventive Maintenance](#)” chapter.

Equipment Required:

110V pump

Screwdriver



Equipment Damage Some internal components can be damaged by small amounts of static electricity. A properly ground antistatic wrist strap must be worn while handling any internal component. ▲

1. Turn instrument OFF, unplug the power cord, and remove the cover.

2. Disconnect pump power line from AC PUMP connector on the measurement interface board.

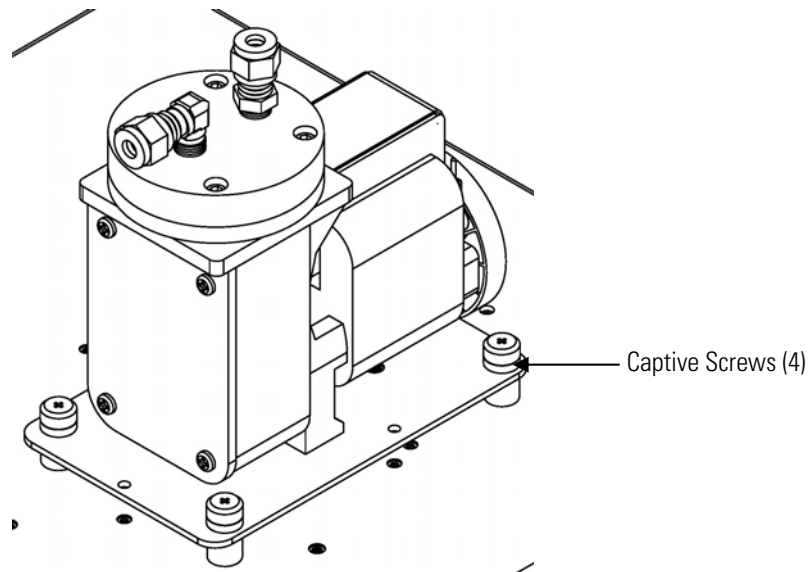

Figure 7-4. Replacing the Pump

3. Remove both lines from pump.
4. Loosen the four captive screws on the mounting plate and remove the pump.
5. Install the new pump by following the previous steps in reverse.

Fan/Filter Replacement

Use the following procedure to replace the rear panel fan and the filter (Figure 7-5).

Equipment Required:

- Fan
- Fan Filter
- Philips screwdriver



Equipment Damage Some internal components can be damaged by small amounts of static electricity. A properly ground antistatic wrist strap must be worn while handling any internal component. ▲

1. Turn the instrument OFF, unplug the power cord, and remove the cover.
2. Remove the fan guard and filter from the rear of the instrument by unsnapping it.
3. If the fan is not being replaced, install the new filter, snap it into place, and skip the remaining steps.
4. Disconnect the fan power cable from the fan.
5. Remove the four fan mounting screws along with nuts and washers and remove the fan.
6. Install a new fan following the previous steps in reverse order.

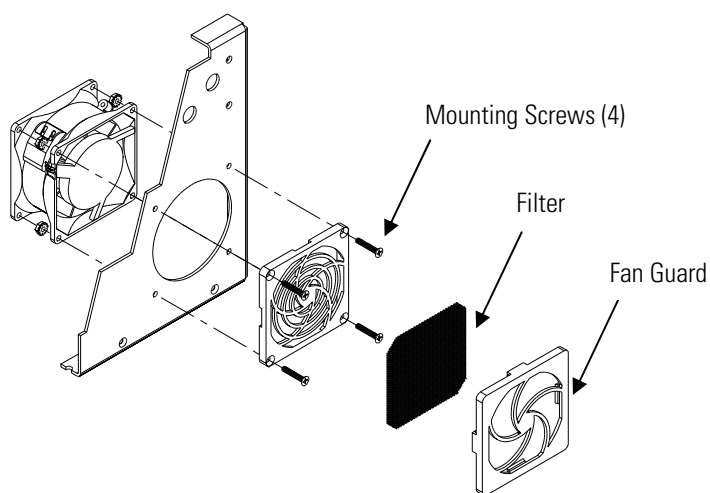

Figure 7-5. Replacing the Fan

PMT Cooler and Reaction Chamber Assembly Replacement

Use the following procedure to replace the PMT cooler and reaction chamber assembly (see [Figure 7-6](#)).

Equipment Required:

- PMT cooler
- Wrench, 7/16-inch
- Wrench, 9/16-inch

Servicing

PMT Cooler and Reaction Chamber Assembly Replacement

Nut driver, 1/4-inch

Philips screwdriver

Wire cutters



Equipment Damage Some internal components can be damaged by small amounts of static electricity. A properly ground antistatic wrist strap must be worn while handling any internal component. ▲

1. Refer to “Removing the Measurement Bench and Lowering the Partition Panel” in this chapter to lower the partition panel, then proceed to the next step below.
2. Disconnect the reaction chamber connector from the temperature control board.
3. Snap off the temperature control board from the board mounts.
4. Remove the four screws securing the cooler shroud to the rear panel and remove the shroud.

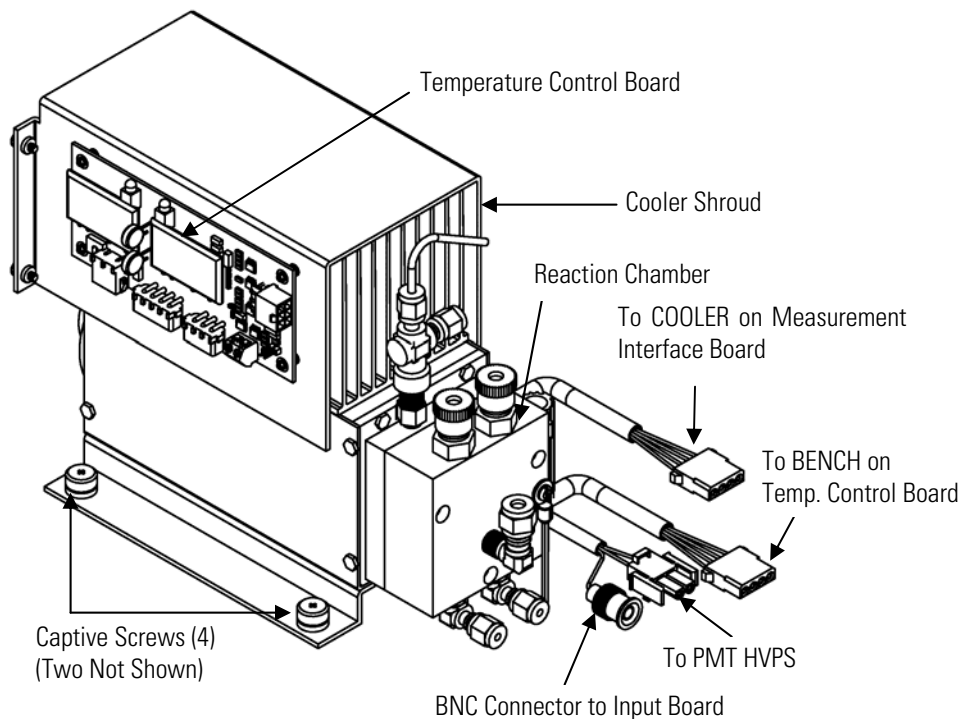

Figure 7–6. PMT Cooler and Reaction Chamber

5. Disconnect plumbing connections from the reaction chamber.
6. Disconnect the cables from the PMT high voltage power supply, the input board, and the measurement interface board. Remove all tie-wraps securing the cables.
7. Loosen four captive screws holding cooler to floor plate and remove the cooler assembly with the reaction chamber.

Note If only the cooler is being replaced, remove the PMT and reaction chamber from the old cooler and install them on the new cooler. ▲

8. Install new cooler by following previous steps in reverse.

Note Fasten knurled fittings on reaction chamber finger tight. ▲

Make sure that the heat shrink covered tubing between the reaction chamber and the converter is light tight at the connections. ▲

9. Re-install the measurement bench. Refer to “[Removing the Measurement Bench and Lowering the Partition Panel](#)” in this chapter.

Photomultiplier Tube Replacement

Use the following procedure to replace the PMT tube.

Equipment Required:

Photomultiplier tube and PMT base

Nut driver, 5/16-inch

Flat blade screwdriver

Philips screwdriver, small



Equipment Damage Some internal components can be damaged by small amounts of static electricity. A properly ground antistatic wrist strap must be worn while handling any internal component. ▲

1. Turn instrument OFF, unplug the power cord, and remove the cover.
2. Disconnect the high voltage cable from the PMT power supply and unplug the BNC cable from the Input Board.

Servicing

PMT High Voltage Power Supply Replacement

3. Remove six external screws holding PMT cover plate and the four screws holding the PMT shroud to the panel and remove the PMT cover plate (Figure 7-7). If the cooler fan is attached, unplug the fan power cord if necessary.

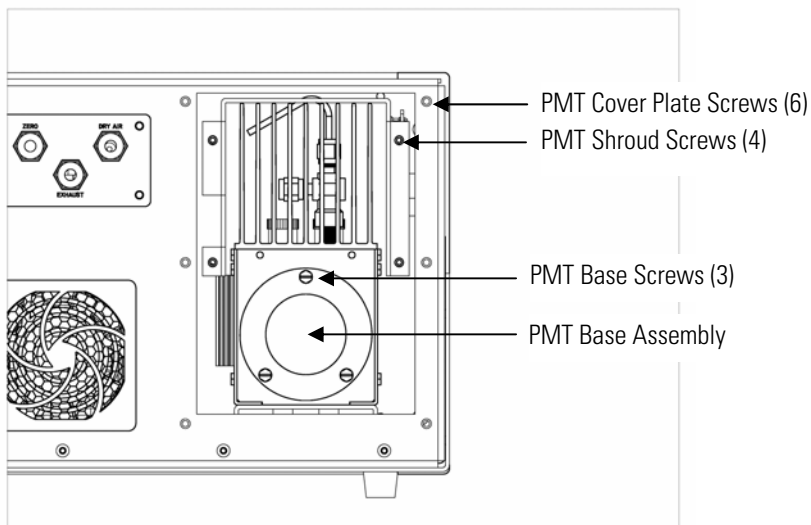

Figure 7-7. Replacing the PMT

4. Remove the three retaining screws holding PMT base assembly to the cooler using a 5/16-inch nut driver.



Equipment Damage Do not point the photomultiplier tube at a light source. This can permanently damage the tube. ▲

5. Pull the PMT and PMT base from cooler assembly by twisting it slightly back and forth.
6. To install PMT, follow previous steps in reverse making sure to backfill the cooler with dry air or nitrogen prior to replacing the PMT.
7. Perform a photomultiplier tube calibration. See “[PMT Voltage Adjustment](#)” in the “[Operation](#)” chapter.

PMT High Voltage Power Supply Replacement

Use the following procedure to replace the PMT high voltage power supply (Figure 7-8).

Equipment Required:

PMT high voltage power supply

Nut driver, 1/4-inch

Philips screwdriver



Equipment Damage Some internal components can be damaged by small amounts of static electricity. A properly ground antistatic wrist strap must be worn while handling any internal component. ▲

1. Turn instrument OFF, unplug the power cord, and remove the cover.
2. Disconnect the two PMT high voltage supply cables.
3. Loosen the two retaining screws securing the assembly bracket to the floor plate and slide the assembly towards the rear slightly and lift it off the base screws.
4. Loosen two screws on the input box assembly and lift the input box assembly off the power supply.
5. Remove the four screws securing the power supply to the bracket and remove the power supply.

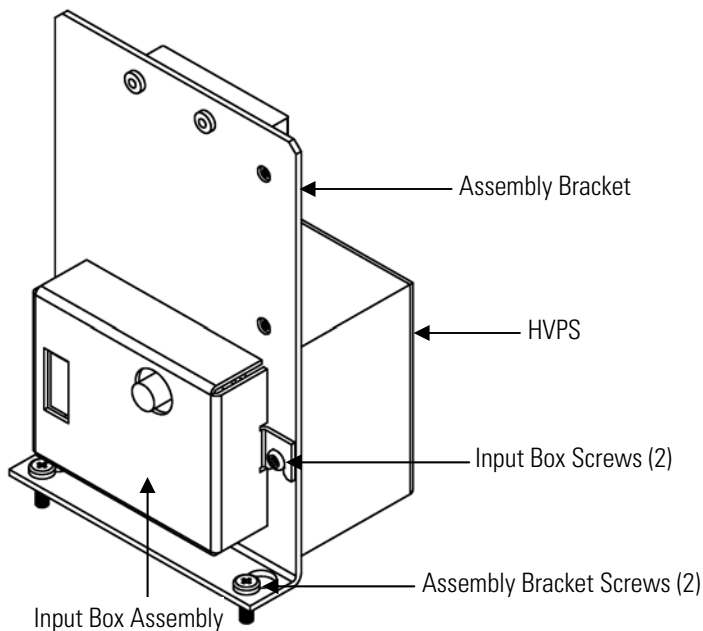

Figure 7–8. Replacing the PMT HVPS





6. To install the power supply, follow the previous steps in reverse.
7. Recalibrate the instrument. Refer to the calibration procedures in the “[Calibration](#)” chapter.

PMT Voltage Adjustment





Use the following procedure to adjust the PMT voltage after switching from standard to extended ranges or vice versa.

WARNING The service procedures in this manual are restricted to qualified service representatives. ▲

1. Select the NO, NO₂, and NO_x ranges. Refer to “[Range Menu](#)” in the “[Operation](#)” chapter.
2. Set the NO BKG and NO_x BKG calibration factors to 0.0. Refer to “[Calibration Factors Menu](#)” in the “[Operation](#)” chapter.
3. Set the NO COEF, NO_x COEF, and NO₂ COEF to 1.000.
4. Set the Averaging Time to 10 seconds. Refer to “[Averaging Time](#)” in the “[Operation](#)” chapter.
5. Connect the calibration gas and allow the instrument to sample calibration gas until the reading stabilizes.
6. From the Main Menu, press  to scroll to Service > press  >  to scroll to **PMT Voltage Adjustment** > and press .

The Set PMT Voltage screen appears.

Note If Service Mode is not displayed, refer to “[Accessing the Service Mode](#)” on page 7-4, then return to the beginning of this step. ▲

7. At the Set PMT Voltage screen, use   to increment/decrement the counts until the instrument displays the calibration gas concentration value.

Reaction Chamber Cleaning or Removal

Use the following procedure to clean or remove the reaction chamber (see [Figure 7-9](#)).

Equipment Required:

Allen Wrench, 9/64-inch

Wrench, 7/16-inch

Wrench, 9/16-inch



Equipment Damage Some internal components can be damaged by small amounts of static electricity. A properly ground antistatic wrist strap must be worn while handling any internal component. ▲

1. Remove PMT cooler as described in “[PMT Cooler and Reaction Chamber Assembly Replacement](#)” in this chapter.
2. Disconnect all plumbing connections from the reaction chamber.
3. Remove the three socket head screws fastening front of reaction chamber to rear ([Figure 7-9](#)). This exposes the inner surfaces of both sections of the reaction chamber and the quartz window. To clean these surfaces use cotton swabs and methanol.
4. To continue removing rear of reaction chamber remove the three socket head screws holding it to cooler, being careful to keep quartz window and red filter in cooler body.
5. To reinstall reaction chamber, follow previous steps in reverse, making sure to backfill the cooler with dry air or nitrogen prior to installing reaction chamber.
6. Re-install the measurement bench. Refer to “[Removing the Measurement Bench and Lowering the Partition Panel](#)” in this chapter.

Servicing

NO₂-to-NO Converter Replacement

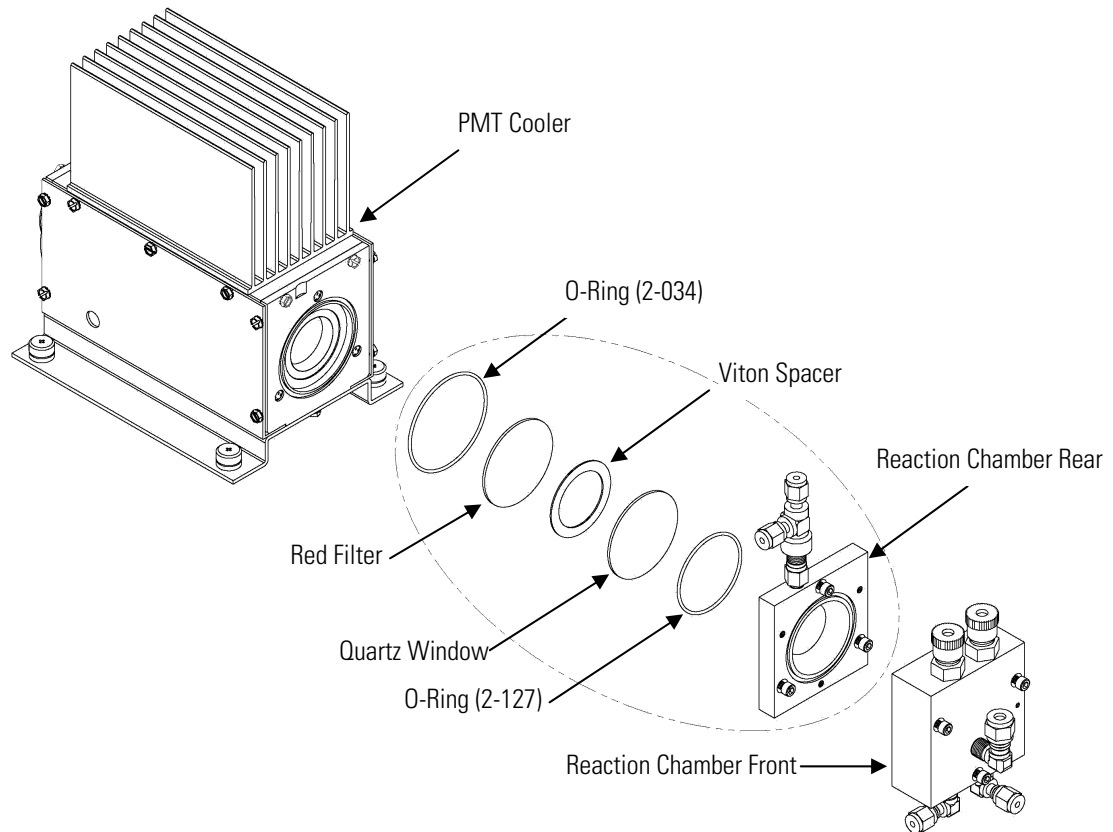

Figure 7–9. Cleaning or Removing the Reaction Chamber

NO₂-to-NO Converter Replacement

Use the following procedure to replace the converter (Figure 7–10).

Equipment Required:

NO₂-to-NO Converter

Wrench, 7/16-inch

Wrench, 9/16-inch

Wrench, 1/2-inch

Wrench, 5/8-inch

Screwdriver

Nut driver, 1/4-inch

Nut driver, 5/16-inch



CAUTION Avoid contact with converter heated components. Allow converter to cool to room temperature before handling converter components. ▲



Equipment Damage Some internal components can be damaged by small amounts of static electricity. A properly ground antistatic wrist strap must be worn while handling any internal component. ▲

1. Turn instrument OFF, unplug the power cord, and remove the cover.
2. Allow converter to cool to room temperature to prevent contact with heated components.
3. Disconnect plumbing at converter inlet and outlet.
4. Disconnect thermocouple leads and heater connector from temperature control board.
5. Loosen the four captive screws holding converter housing to floor plate.

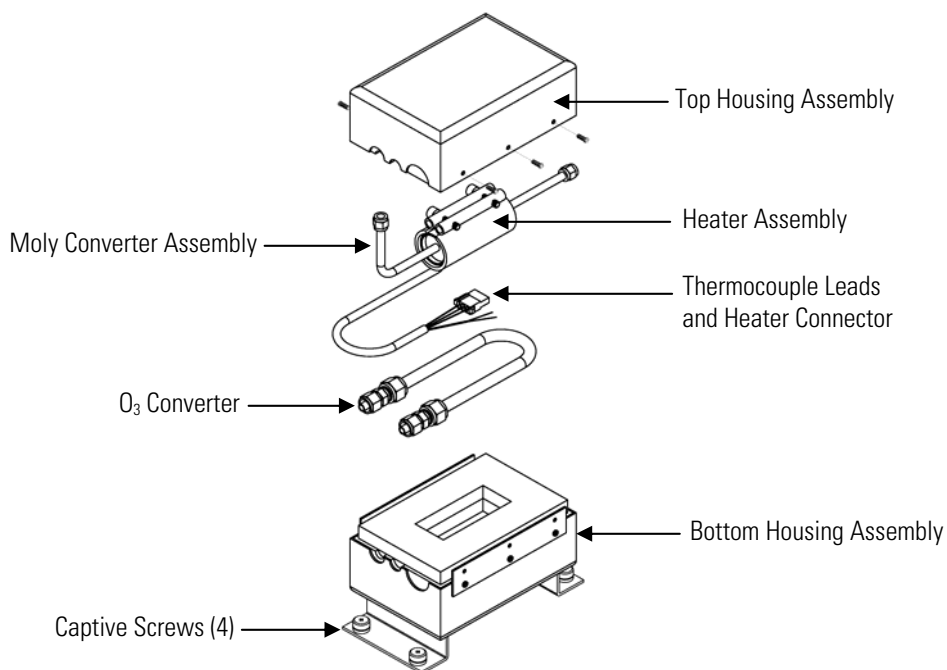

Figure 7–10. NO₂-to-NO Molybdenum Converter Assembly

6. Remove the six screws holding the top housing assembly to the bottom half.
7. Remove the converter cartridge/heater assembly from the bottom housing assembly.
8. Loosen the heater clamp, pry heater apart no wider than necessary and remove the converter cartridge noting the proper orientation of heater wires and thermocouple probe.
9. To replace converter, follow previous steps in reverse. **Note** Be sure to wrap the O₃ converter tube snugly around the heater.

Solenoid Valve Replacement

Use the following procedure to replace the solenoid valve (Figure 7–11).

Equipment Required:

Solenoid valve

Wrench, 5/16-inch

Philips screwdriver



Equipment Damage Some internal components can be damaged by small amounts of static electricity. A properly ground antistatic wrist strap must be worn while handling any internal component. ▲

1. Refer to “[Removing the Measurement Bench and Lowering the Partition Panel](#)” in this chapter to lower the partition panel, then proceed to the next step below.
2. Disconnect solenoid from the Measurement Interface board (NO/NO_x connector). Note electrical connections to facilitate re-connection.
3. Remove plumbing from solenoid. Note plumbing connections to facilitate re-connection.
4. Pull solenoid valve from mounting clip.
5. To replace solenoid, follow previous steps in reverse.

6. Re-install the measurement bench. Refer to “[Removing the Measurement Bench and Lowering the Partition Panel](#)” in this chapter.

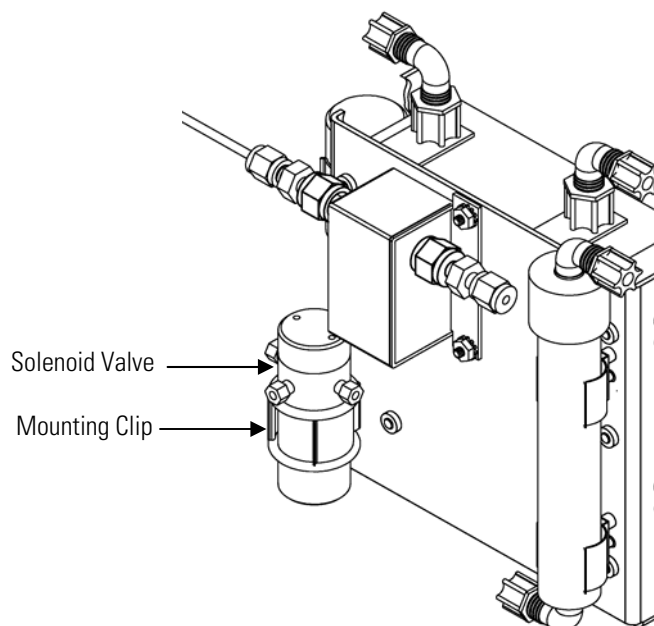

Figure 7–11. Replacing the Solenoid Valve

Ozonator Assembly Replacement

Use the following procedure to replace the ozonator assembly ([Figure 7–12](#)).

Equipment Required:

Ozonator assembly

Wrench, 5/8-inch

Philips screwdriver



Equipment Damage Some internal components can be damaged by small amounts of static electricity. A properly ground antistatic wrist strap must be worn while handling any internal component. ▲

1. Refer to “[Removing the Measurement Bench and Lowering the Partition Panel](#)” in this chapter to lower the partition panel, then proceed to the next step below.

Servicing

Ozonator Assembly Replacement

2. Carefully disconnect the plumbing at the glass inlet and outlet of the ozonator.
3. Disconnect the stainless steel tubing from the flow transducer.
4. Loosen the four captive screws securing the ozonator bracket to the floor plate.

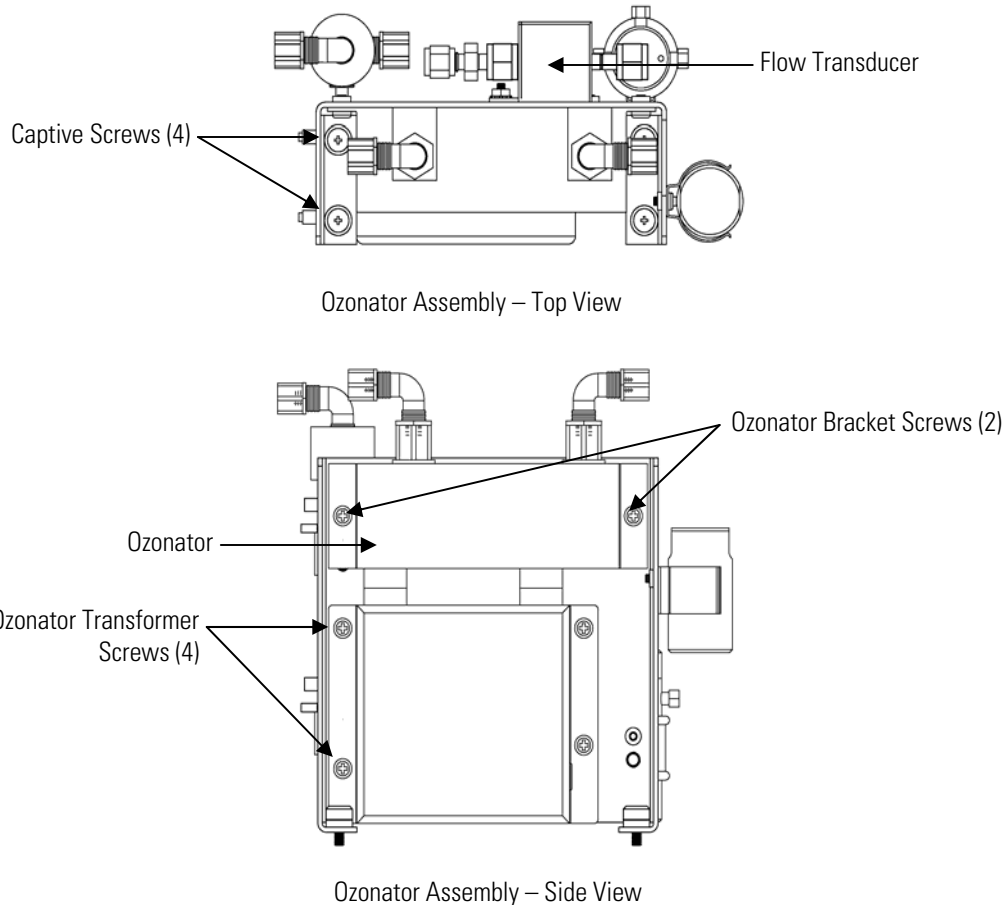

Figure 7-12. Replacing the Ozonator Assembly

5. Remove the two screws securing the ozonator to the ozonator bracket.
6. Unplug the ozonator from the ozonator transformer by lifting the ozonator straight up.
7. To install the ozonator, follow the previous steps in reverse.

8. Re-install the measurement bench. Refer to “[Removing the Measurement Bench and Lowering the Partition Panel](#)” in this chapter.

Ozonator Transformer Replacement

Use the following procedure to replace the ozonator transformer (Figure 7–12).

Equipment Required:

- Ozonator transformer
- Philips screwdriver



Equipment Damage Some internal components can be damaged by small amounts of static electricity. A properly ground antistatic wrist strap must be worn while handling any internal component. ▲

1. Turn instrument OFF, unplug the power cord, and remove the cover.
2. Remove the ozonator assembly as described in “[Ozonator Assembly Replacement](#)”.
3. Disconnect the plug connecting the ozonator transformer to the measurement interface board (OZONATOR connector).
4. Remove the four screws holding the ozonator transformer to the ozonator bracket and remove the ozonator transformer.
5. To install the ozonator transformer, follow the previous steps in reverse.
6. Re-install the measurement bench. Refer to “[Removing the Measurement Bench and Lowering the Partition Panel](#)” in this chapter.

Input Board Replacement

Use the following procedure to replace the input board (Figure 7–13).

Equipment Required:

- Input board
- Philips screwdriver



Equipment Damage Some internal components can be damaged by small amounts of static electricity. A properly ground antistatic wrist strap must be worn while handling any internal component. ▲

1. Refer to “[Removing the Measurement Bench and Lowering the Partition Panel](#)” in this chapter to lower the partition panel, then proceed to the next step below.
2. Disconnect the coaxial cable with BNC connector and the ribbon cable.
3. Loosen the two screws holding the assembly bracket to the floor plate, move the assembly towards the rear, and lift the assembly off the screws.
4. Loosen the two screws holding the input box to the assembly bracket and lift the input box off the screws.

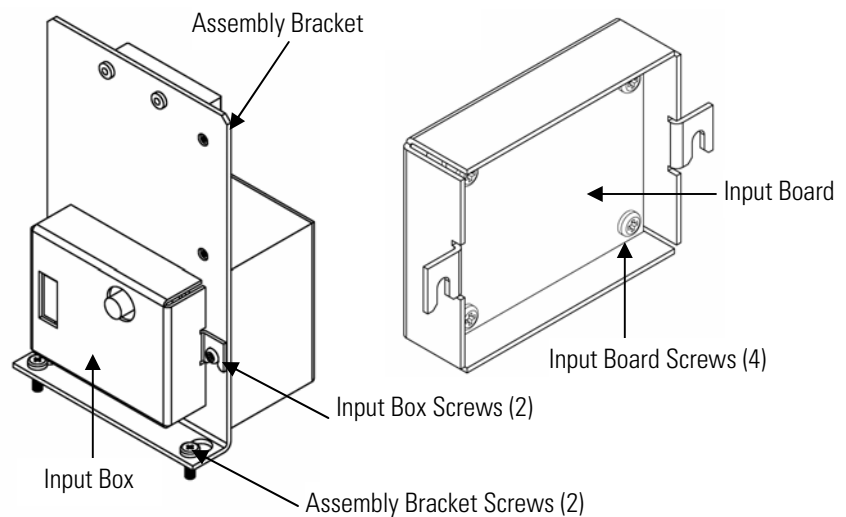

Figure 7-13. Replacing the Input Board

5. Remove the four screws holding the input board to the input box and remove the input board.
6. Install the input board by following the previous steps in reverse.
7. Re-install the measurement bench. Refer to “[Removing the Measurement Bench and Lowering the Partition Panel](#)” in this chapter.
8. Perform an input board calibration. See the “[Input Board Calibration](#)” procedure that follows.

Input Board Calibration



After replacing the input board, use the following procedure to calibrate the input board.

WARNING The service procedures in this manual are restricted to qualified service representatives. ▲

1. From the Main Menu, press to scroll to Service > press > to scroll to Input Board Calibration > and press .

The Input Board Calibration screen appears.

Note If Service Mode is not displayed, refer to “[Accessing the Service Mode](#)” on page 7-4 , then return to the beginning of this step. ▲

2. At the Input Board Calibration screen, press to select Manual Input Cal, and press to calibrate.

The screen displays the frequency at GAIN 1.

3. Make a note of the FREQ value displayed at GAIN 1, then press or to change the GAIN to 100.

4. At the GAIN 100 screen, use to increment the D/A counts until the FREQ value matches or is slightly above (within 50 counts) the value noted in the previous step.

5. Press to store the value.

The screen flashes **Calculating - Please Wait!** and **Done - Values Saved!** messages.

DC Power Supply Replacement

Use the following procedure to replace the DC power supply ([Figure 7-14](#)).

Equipment Required:

DC power supply

Philips screwdriver



Equipment Damage Some internal components can be damaged by small amounts of static electricity. A properly ground antistatic wrist strap must be worn while handling any internal component. ▲

1. Turn instrument OFF, unplug the power cord, and remove the cover.
2. Disconnect all the power supply electrical connections. Note connector locations to facilitate re-connection.
3. Loosen the captive screw securing the power supply to the chassis plate and lift out the power supply.

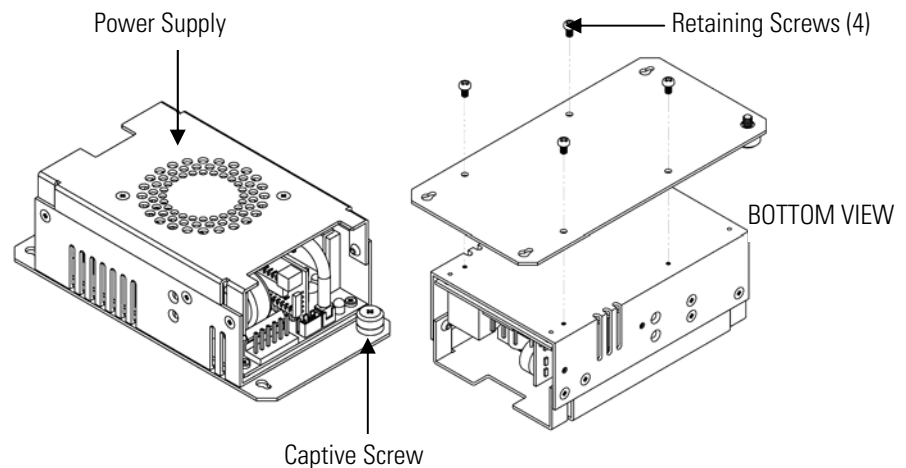

Figure 7-14. Replacing the DC Power Supply

4. Turn the power supply upside down and remove the four retaining screws securing the power supply to the power supply plate and remove the power supply.
5. To install the DC power supply, follow the previous steps in reverse.

Analog Output Testing

The analog outputs should be tested if the concentration value on the front panel display disagrees with the analog outputs. To check the analog outputs, you connect a meter to an analog output channel (voltage or current) and compare the meter reading with the output value set on the Test Analog Outputs screen.

Equipment Required:

Multimeter

Use the following procedure to test the analog outputs.

1. Connect a meter to the channel to be tested. [Figure 7-15](#) shows the analog output pins and [Table 7-4](#) identifies the associated channels.

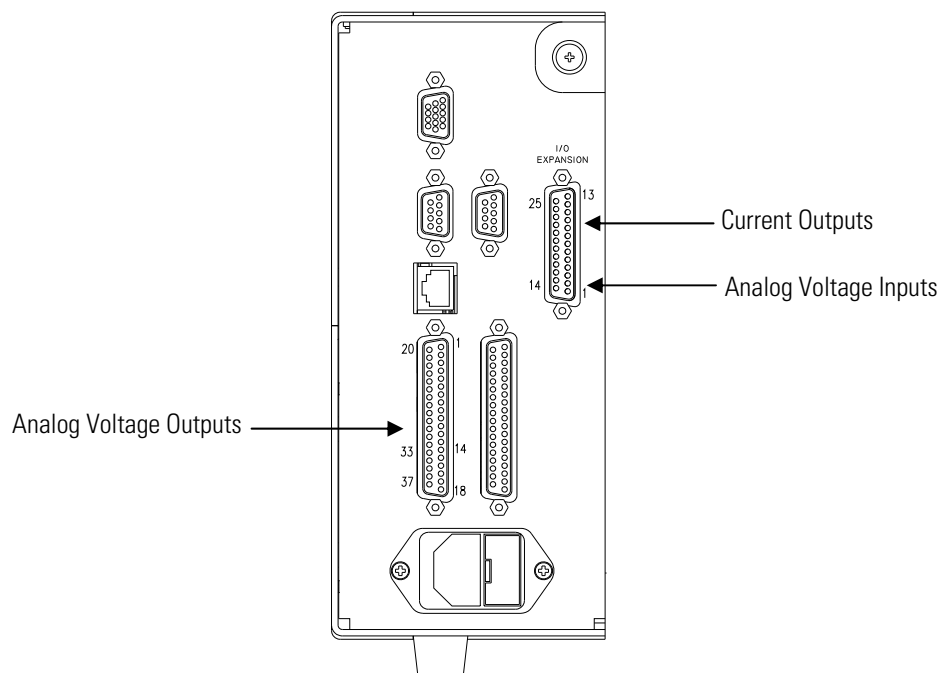



Figure 7-15. Rear Panel Analog Input and Output Pins

2. From the Main Menu, press to scroll to Diagnostics, > press > to scroll to Test Analog Outputs, and press .
- The Test Analog Outputs screen appears.
3. Press to scroll to the desired channel corresponding to the rear panel terminal pins where the meter is connected, and press .
- The Set Analog Outputs screen appears.
4. Press to set the output to zero.
- The Output Set To line displays Zero.

5. Check that the meter is displaying the zero value. If the meter reading differs by more than one percent, the analog outputs should be adjusted. Refer to the “[Analog Output Calibration](#)” procedure that follows.

6. Press  to set the output to full-scale.
The Output Set To line displays Full-Scale.

7. Check that the meter is displaying a full-scale value. If the meter reading differs by more than one percent, the analog outputs should be adjusted. Refer to the “[Analog Output Calibration](#)” procedure b.

8. Press  to reset the analog outputs to normal.

Table 7–4. Analog Output Channels and Rear Panel Pin Connections

Voltage Channel	Pin	Current Channel	Pin
1	14	1	15
2	33	2	17
3	15	3	19
4	34	4	21
5	17	5	23
6	36	6	25
Ground	16, 18, 19, 35, 37	Current Output Return	13, 16, 18, 20, 22, 24

Table 7–5. Analog Input Channels and Rear Panel Pin Connections

Input Channel	Pin
1	1
2	2
3	3
4	5
5	6
6	7
7	9
8	10
Ground	4, 8, 11, 14

Analog Output Calibration

Use the following procedure to calibrate the analog outputs if a meter reading in the “[Analog Output Testing](#)” procedure differed by more than one percent or after replacing the optional I/O expansion board.

Equipment Required:



Multimeter

1. Connect a meter to the channel to be adjusted and set to voltage or current as appropriate. [Figure 7-15](#) shows the analog output pins and [Table 7-4](#) identifies the associated channels.

2. From the Main Menu, press  to scroll to Service > press  >  to scroll to Analog Output Calibration > and press .

The Analog Output Cal screen appears.

Note If Service Mode is not displayed, refer to “[Accessing the Service Mode](#)” on page 7-4 , then return to the beginning of this step. ▲

3. At the Analog Output Cal screen, press  to scroll to the desired voltage channel or current channel corresponding to the rear panel terminal pin where the meter is connected, then press .



4. With the cursor at Calibrate Zero, press .

The Analog Output Cal line displays Zero

Note When calibrating the analog output, always calibrate zero first and then calibrate full-scale. ▲

5. Use   until the meter reads 0.0V (or 0.0 or 4.0 mA for a current channel), then press  to save the value.

6. Press  to return to the previous screen.

7. Press   to select Calibrate Full-Scale.

8. Use   until the meter reads the value shown in the Set Output To line, then press  to save the value.

Analog Input Calibration

Use the following procedures to calibrate the analog inputs after replacing the optional I/O expansion board. These procedures include selecting analog input channels, calibrating them to zero volts, and then calibrating them to full-scale using a known voltage source.



Calibrating the Input Channels to Zero Volts

Use the following procedure to calibrate the input channels to zero volts.

1. From the Main Menu, press  to scroll to Service, press  >  to scroll to Analog Input Calibration, and press .

2. The Analog Input Cal screen displays.

Note If Service Mode is not displayed, refer to “[Accessing the Service Mode](#)” on page 7-4, then return to the beginning of this step. ▲



3. At the Analog Input Cal screen, press  to scroll to a channel, and press .

4. With the cursor at Calibrate Zero, press .

The screen displays the input voltage for the selected channel.

5. Make sure that nothing is connected to the channel input pins and press  to calibrate the input voltage on the selected channel to zero volts.

The screen displays 0.00 V as the voltage setting.

6. Press  >  to return to the Analog Input Cal screen and repeat Steps 2 through 4 to calibrate other input channels to zero as necessary.















7. Continue with the “[Calibrating the Input Channels to Full-Scale](#)” procedure that follows.

Calibrating the Input Channels to Full-Scale

Use the following procedure to calibrate the input channels to full scale by applying a known voltage to the channels.

Equipment Required:

DC voltage source (greater than 0 volts and less than 10 volts)

1. Connect the known DC voltage source to the input channel (1-8) to be calibrated. [Figure 7-15](#) shows the analog output pins and [Table 7-5](#) identifies the associated channels.
2. From the Main Menu, press  to scroll to Service, press  >  to scroll to Analog Input Calibration, and press .
The Analog Input Cal screen displays input channels 1-8.
3. At the Analog Input Cal screen, press  to scroll to the channel selected in Step 1, and press .
4. Press  to scroll to Calibrate Full Scale, and press .
The screen displays the current input voltage for the selected channel.
5. Use   and   to enter the source voltage, and press  to calibrate the input voltage for the selected channel to the source voltage.
6. Press  >  to return to the input channels display and repeat Steps 3-5 to calibrate other input channels to the source voltage as necessary.

Pressure Transducer Assembly Replacement

Use the following procedure to replace the pressure transducer assembly ([Figure 7-16](#)).

Equipment Required:

Pressure transducer assembly

Philips screwdriver



Equipment Damage Some internal components can be damaged by small amounts of static electricity. A properly ground antistatic wrist strap must be worn while handling any internal component. ▲

1. Turn instrument OFF, unplug the power cord, and remove the cover.

Servicing

Pressure Transducer Calibration

2. Disconnect plumbing from the pressure transducer assembly. Note the plumbing connections to facilitate reconnection.
3. Disconnect the pressure transducer cable.

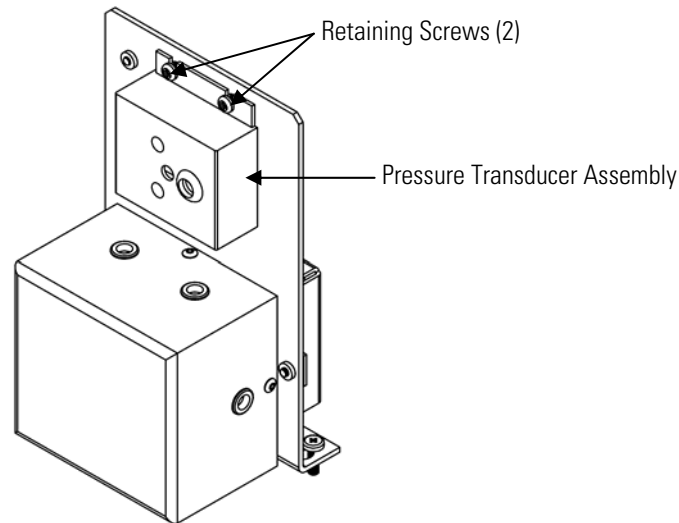

Figure 7-16. Replacing the Pressure Transducer

4. Remove the two pressure transducer assembly retaining screws and remove the pressure transducer assembly.
5. To install the pressure transducer assembly, follow previous steps in reverse.
6. Calibrate the pressure transducer. Refer to the “[Pressure Transducer Calibration](#)” procedure that follows.

Pressure Transducer Calibration

Use the following procedure to calibrate the pressure transducer.

Equipment Required:

Vacuum pump



WARNING The service procedures in this manual are restricted to qualified service representatives. ▲

If the equipment is operated in a manner not specified by the manufacturer, the protection provided by the equipment may be impaired. ▲







Equipment Damage Some internal components can be damaged by small amounts of static electricity. A properly ground antistatic wrist strap must be worn while handling any internal component. ▲

Note An error in the zero setting of the pressure transducer does not introduce a measurable error in the output concentration reading. Therefore, if only a barometer is available and not a vacuum pump, only adjust the span setting. ▲



A rough check of the pressure accuracy can be made by obtaining the current barometric pressure from the local weather station or airport and comparing it to the pressure reading. However, since these pressures are usually corrected to sea level, it may be necessary to correct the reading to local pressure by subtracting 0.027 mmHg per foot of altitude. ▲









Do not try to calibrate the pressure transducer unless the pressure is known accurately. ▲

1. Remove the cover.
2. Disconnect the tubing from the pressure transducer and connect a vacuum pump known to produce a vacuum less than 1 mm Hg.
3. From the Main Menu, press  to scroll to Service > press  >  to scroll to Pressure Calibration > and press .

The Pressure Sensor Cal menu appears.

Note If Service Mode is not displayed, refer to “[Accessing the Service Mode](#)” on page 7-4 , then return to the beginning of this step. ▲

4. At the Pressure Sensor Cal menu, press  to select **Zero**.
The Calibrate Pressure Zero screen appears.
5. Wait at least 10 seconds for the zero reading to stabilize, then press  to save the zero pressure value.

6. Disconnect the pump from the pressure transducer.
7. Press  to return to the Pressure Sensor Cal menu.
8. At the Pressure Sensor Cal menu, press   to select **Span**.
The Calibrate Pressure Span screen appears.
9. Wait at least 10 seconds for the ambient reading to stabilize, use   and   to enter the known barometric pressure, and press  to save the pressure value.
10. Reconnect the instrument tubing to the pressure transducer.
11. Install the cover.

Temperature Control Board Replacement

Use the following procedure to replace the temperature control board (Figure 7-6).

Equipment Required:

Temperature control board

Small flat-blade screwdriver



Equipment Damage Some internal components can be damaged by small amounts of static electricity. A properly ground antistatic wrist strap must be worn while handling any internal component. ▲

1. Turn instrument OFF, unplug the power cord, and remove the cover.
2. Disconnect all connectors from the temperature control board. Use a small flat-blade screwdriver to loosen the two screws securing the CONV TC cable. Note that the red wire is towards the rear and the yellow wire is towards the front.
3. Snap off the board from the board mounts.
4. To install the temperature control board, follow previous steps in reverse.

Ambient Temperature Calibration

Use the following procedure to calibrate the ambient internal temperature for the instrument.

Equipment Required:

Calibrated thermometer or 10K \pm 1% Resistor



WARNING The service procedures in this manual are restricted to qualified service representatives. ▲

If the equipment is operated in a manner not specified by the manufacturer, the protection provided by the equipment may be impaired. ▲







Equipment Damage Some internal components can be damaged by small amounts of static electricity. A properly ground antistatic wrist strap must be worn while handling any internal component. ▲

1. Remove the instrument cover.
2. Tape the thermistor (plugged into the measurement interface board) to a calibrated thermometer (Figure 7-2).





Note Since the thermistors are interchangeable to an accuracy of ± 0.2 °C, and have a value of 10K ohms at 25 °C, an alternate procedure is to connect an accurately known 10K resistor to the thermistor input (AMB TEMP) on the measurement interface board, and enter the temperature reading. ▲

A 1 °C change corresponds to a $\pm 5\%$ change in resistance, thus this alternative procedure can be quite accurate as a check; however, it clearly is not NIST traceable. ▲

3. From the Main Menu, press  to scroll to Service > press  >  to scroll to **Temperature Calibration** > and press .

The Calibrate Ambient Temperature screen appears.

Note If Service Mode is not displayed, refer to “[Accessing the Service Mode](#)” on page 7-4 , then return to the beginning of this step. ▲

4. Wait at least 10 seconds for the ambient reading to stabilize, use   and   to enter the known temperature, and press  to save the temperature value.
5. Install the cover.

Fuse Replacement

Use the following procedure to replace the fuse.

Equipment Required:

Replacement fuses:

250VAC, 4 Amp, SlowBlow (for 100VAC and 110VAC models)

250VAC, 2 Amp, SlowBlow (for 220-240VAC models)

1. Turn instrument OFF and unplug the power cord.
2. Remove fuse drawer, located on the AC power connector.
3. If either fuse is blown, replace both fuses.
4. Insert fuse drawer and reconnect power cord.

Scrubber Replacement

Use the following procedure to replace the ammonia scrubber (Figure 7–17).

Equipment Required:

Ammonia scrubber

Nut driver, 3/16-inch



Equipment Damage Some internal components can be damaged by small amounts of static electricity. A properly ground antistatic wrist strap must be worn while handling any internal component. ▲

1. Turn instrument OFF, unplug the power cord, and remove the cover.
2. Unscrew the Teflon tubing at both ends of the scrubber.
3. Pull the scrubber off the mounting clips.

4. Push the replacement scrubber into the mounting clips.
5. Attach the Teflon tubing at both ends of the scrubber.
6. Replace the cover.

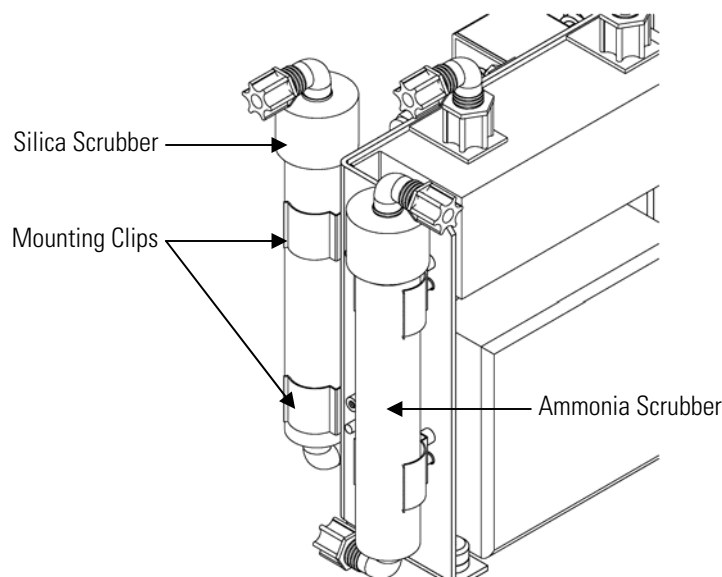

Figure 7-17. Replacing the Scrubber

I/O Expansion Board (Optional) Replacement

Use the following procedure to replace the optional I/O expansion board (Figure 7-18).

Equipment Required:

- I/O expansion board
- Nut driver, 3/16-inch



Equipment Damage Some internal components can be damaged by small amounts of static electricity. A properly ground antistatic wrist strap must be worn while handling any internal component. ▲

1. Turn instrument OFF, unplug the power cord, and remove the cover.
2. Unplug the I/O expansion board cable from the EXPANSION BD connector on the motherboard.

Servicing

I/O Expansion Board (Optional) Replacement

3. Remove the two standoffs holding the I/O expansion board connector to the rear panel (Figure 7-19).
4. Pop off the board from the mounting studs and remove the board.
5. To install the I/O expansion board, follow previous steps in reverse.
6. Calibrate the analog current outputs and analog voltage inputs as defined earlier in this chapter.

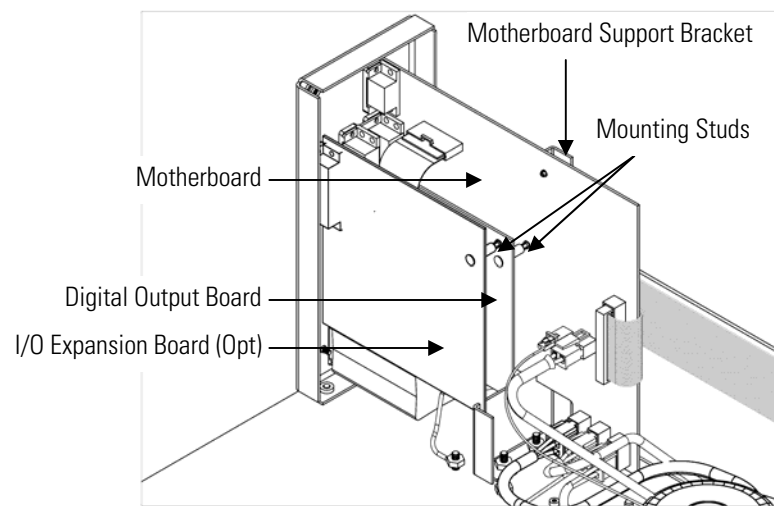

Figure 7-18. Replacing the I/O Expansion Board (Optional)

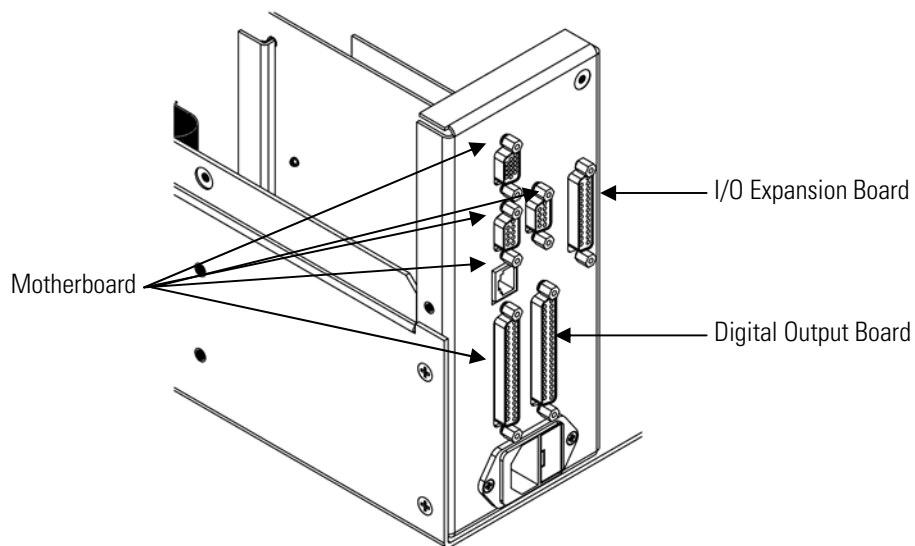

Figure 7-19. Rear Panel Board Connectors

Digital Output Board Replacement

Use the following procedure to replace the digital output board (Figure 7-18).

Equipment Required:

- Digital output board
- Nut driver, 3/16-inch



Equipment Damage Some internal components can be damaged by small amounts of static electricity. A properly ground antistatic wrist strap must be worn while handling any internal component. ▲

1. Turn instrument OFF, unplug the power cord, and remove the cover.
2. Remove the I/O expansion board (optional), if used. See the “[I/O Expansion Board \(Optional\) Replacement](#)” procedure in this chapter.
3. Disconnect the digital output board ribbon cable from the motherboard.
4. Using the nut driver, remove the two standoffs securing the board to the rear panel (Figure 7-19).
5. Pop off the digital output board from the mounting studs and remove the board.
6. To install the digital output board, follow previous steps in reverse.

Motherboard Replacement

Use the following procedure to replace the motherboard (Figure 7-18).

Equipment Required:

- Motherboard
- Philips screwdriver
- Nut driver, 3/16-inch



Equipment Damage Some internal components can be damaged by small amounts of static electricity. A properly ground antistatic wrist strap must be worn while handling any internal component. ▲

1. Turn instrument OFF, unplug the power cord, and remove the cover.
2. Remove the I/O expansion board (optional), if used. See the “I/O Expansion Board Replacement” procedure in this chapter.
3. Remove the digital output board. See the “[Digital Output Board Replacement](#)” procedure in this chapter.
4. Unplug all connectors from the motherboard. Note connector locations to facilitate reconnection.
5. Using the nut driver, remove the eight standoffs securing the board to the rear panel.
6. Pop off the motherboard from motherboard support bracket, and remove the motherboard.
7. To install the motherboard, follow previous steps in reverse.
8. Calibrate the analog voltage outputs as defined earlier in this chapter (all ranges).

Measurement Interface Board Replacement

Use the following procedure to replace the measurement interface board ([Figure 7–20](#)).

Equipment Required:

Measurement interface board

Philips screwdriver



Equipment Damage Some internal components can be damaged by small amounts of static electricity. A properly ground antistatic wrist strap must be worn while handling any internal component. ▲

1. Lower the partition panel, then proceed to the next step below. Refer to “[Removing the Measurement Bench and Lowering the Partition Panel](#)” on page 7-8 in this chapter.
2. Unplug all connectors. Note the locations of the connectors to facilitate reconnection.

3. Unscrew the two screws at the top of the measurement interface board. Pop off the measurement interface board from the two bottom mounting studs and remove the board (Figure 7–20).
4. To install the measurement interface board, follow previous steps in reverse.
5. Re-install the measurement bench.
6. Calibrate the PMT voltage, pressure transducer, flow transducer, input board, and ambient temperature sensor as defined earlier in this chapter.

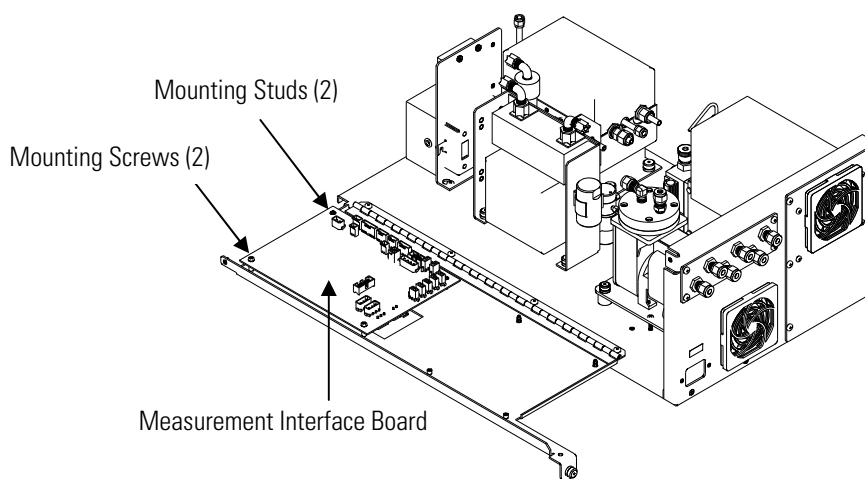

Figure 7–20. Replacing the Measurement Interface Board

Flow Transducer Replacement

Use the following procedure to replace the flow transducer (Figure 7–21).

Equipment Required:

Flow transducer



Equipment Damage Some internal components can be damaged by small amounts of static electricity. A properly ground antistatic wrist strap must be worn while handling any internal component. ▲

1. Turn instrument OFF, unplug the power cord, and remove the cover.

Servicing

Flow Transducer Calibration

2. Disconnect the plumbing connections from the flow transducer. Note the plumbing connections to facilitate reconnection.

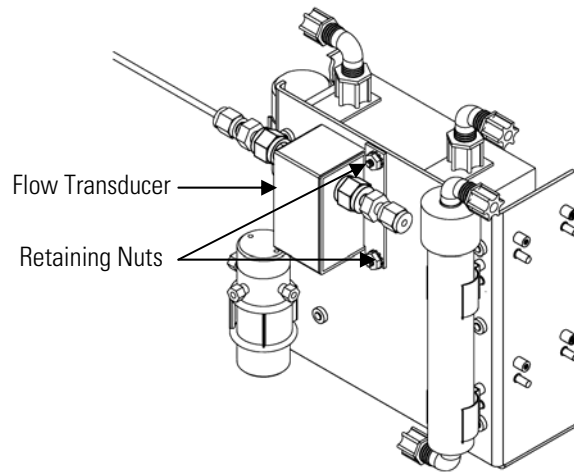

Figure 7-21. Replacing the Flow Transducer

3. Disconnect the flow transducer cable from the measurement interface board.
4. Loosen the two retaining nuts securing the flow transducer to the ozonator bracket and remove the flow transducer.
5. To install the flow transducer, follow previous steps in reverse.
6. Calibrate the flow transducer. Refer to the “[Flow Transducer Calibration](#)” procedure that follows.

Flow Transducer Calibration

Use the following procedure to calibrate the flow transducer.

Equipment Required:

Calibrated flow sensor







WARNING The service procedures in this manual are restricted to qualified service representatives. ▲

If the equipment is operated in a manner not specified by the manufacturer, the protection provided by the equipment may be impaired. ▲







Equipment Damage Some internal components can be damaged by small amounts of static electricity. A properly ground antistatic wrist strap must be worn while handling any internal component. ▲

1. Remove the cover.
2. Disconnect the pump cable from AC PUMP connector on the measurement interface board.
3. From the Main Menu, press  to scroll to Service > press  >  to scroll to **Flow Calibration** > and press .





The Flow Sensor Cal menu appears.

Note If Service Mode is not displayed, refer to “[Accessing the Service Mode](#)” on page 7-4 , then return to the beginning of this step. ▲

4. At the Flow Sensor Cal menu, press  to select **Zero**.
The Calibrate Flow Zero screen appears.
5. Wait at least 10 seconds for the zero reading to stabilize, then press  to save the zero flow value.
6. Reconnect the pump cable to the AC PUMP connector on the measurement interface board.
7. Connect a calibrated flow sensor at the SAMPLE bulkhead on the rear panel.
8. Press  to return to the Flow Sensor Cal menu.
9. At the Flow Sensor Cal menu, press   to select **Span**.
The Calibrate Flow Span screen appears.

Servicing

Front Panel Board Replacement

10. Wait at least 10 seconds for the reading to stabilize, use   and   to enter the flow sensor reading, and press  to save the value.

11. Install the cover.

Front Panel Board Replacement

Use the following procedure to replace the front panel board (Figure 7-22).

Equipment Required:

Front panel board



Equipment Damage Some internal components can be damaged by small amounts of static electricity. A properly ground antistatic wrist strap must be worn while handling any internal component. ▲

1. Turn instrument OFF, unplug the power cord, and remove the cover.
2. Remove the three ribbon cables and the two-wire connector from the front panel board.
3. Pop off the board from the two top mounting studs and remove the board by lifting it up and off the slotted bottom support.
4. Replace the front panel board by following previous steps in reverse.

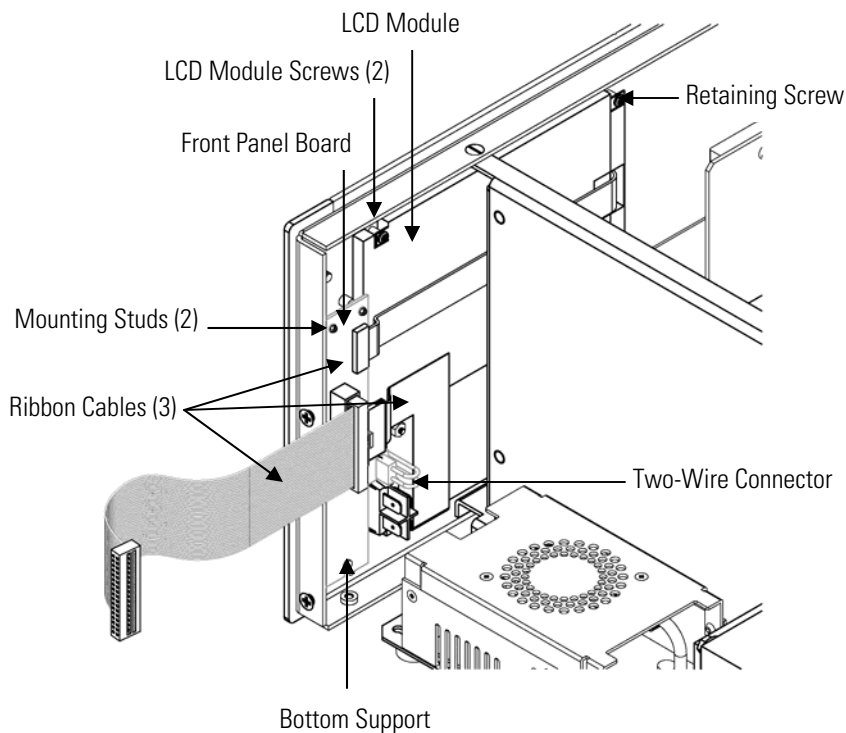

Figure 7–22. Replacing the Front Panel Board and the LCD Module

LCD Module Replacement

Use the following procedure to replace the LCD module (Figure 7–22).

Equipment Required:

LCD module

Philips screwdriver



CAUTION If the LCD panel breaks, do not let the liquid crystal contact your skin or clothes. If the liquid crystal contacts your skin or clothes, wash it off immediately using soap and water. ▲



Equipment Damage Some internal components can be damaged by small amounts of static electricity. A properly ground antistatic wrist strap must be worn while handling any internal component. ▲

Do not remove the LCD panel or frame from the LCD module. ▲

The LCD polarizing plate is very fragile, handle it carefully. ▲

Do not wipe the LCD polarizing plate with a dry cloth, it may easily scratch the plate. ▲

Do not use alcohol, acetone, MEK or other Ketone based or aromatic solvents to clean the LCD module, use a soft cloth moistened with a naphtha cleaning solvent. ▲

Do not place the LCD module near organic solvents or corrosive gases. ▲

Do not shake or jolt the LCD module. ▲

1. Turn instrument OFF, unplug the power cord, and remove the cover.
2. Disconnect the ribbon cable and the two-wire connector from the front panel board.
3. Remove the four screws at the corners of the LCD module.
4. Slide the LCD module out towards the center of the instrument.
5. Replace the LCD module by following previous steps in reverse.

Note The optimal contrast will change from one LCD screen to another. After replacing the LCD screen, the contrast may need to be reset. If the content on the screen is visible, select Instrument Controls > **Screen Contrast** and adjust the screen contrast. If the content on the screen is not visible, use the “set contrast 10” C-Link command to set screen contrast to mid range, then optimize the contrast. See the “C-Link Protocol Commands” appendix for more information on this command. ▲

Service Locations

For additional assistance, service is available from exclusive distributors worldwide. Contact one of the phone numbers below for product support and technical information or visit us on the web at www.thermo.com/aqi.

1-866-282-0430 Toll Free

1-508-520-0430 International

Chapter 8

System Description

This chapter describes the function and location of the system components, provides an overview of the software structure, and includes a description of the system electronics and input/output connections and functions as follows:

- “Hardware” on page 8-1
- “Software” on page 8-4
- “Electronics” on page 8-6
- “I/O Components” on page 8-9

Hardware

Model 42*i* hardware components (Figure 8–1) include:

- NO₂-to-NO converter
 - Mode solenoid
- Reaction chamber
 - Optical filter
 - Pressure transducer
 - Sample flow sensor
- Ozonator
 - Ozone flow switch
- Photomultiplier tube
- Photomultiplier tube cooler
- Pump
 - Sample capillary
 - Dry air capillary

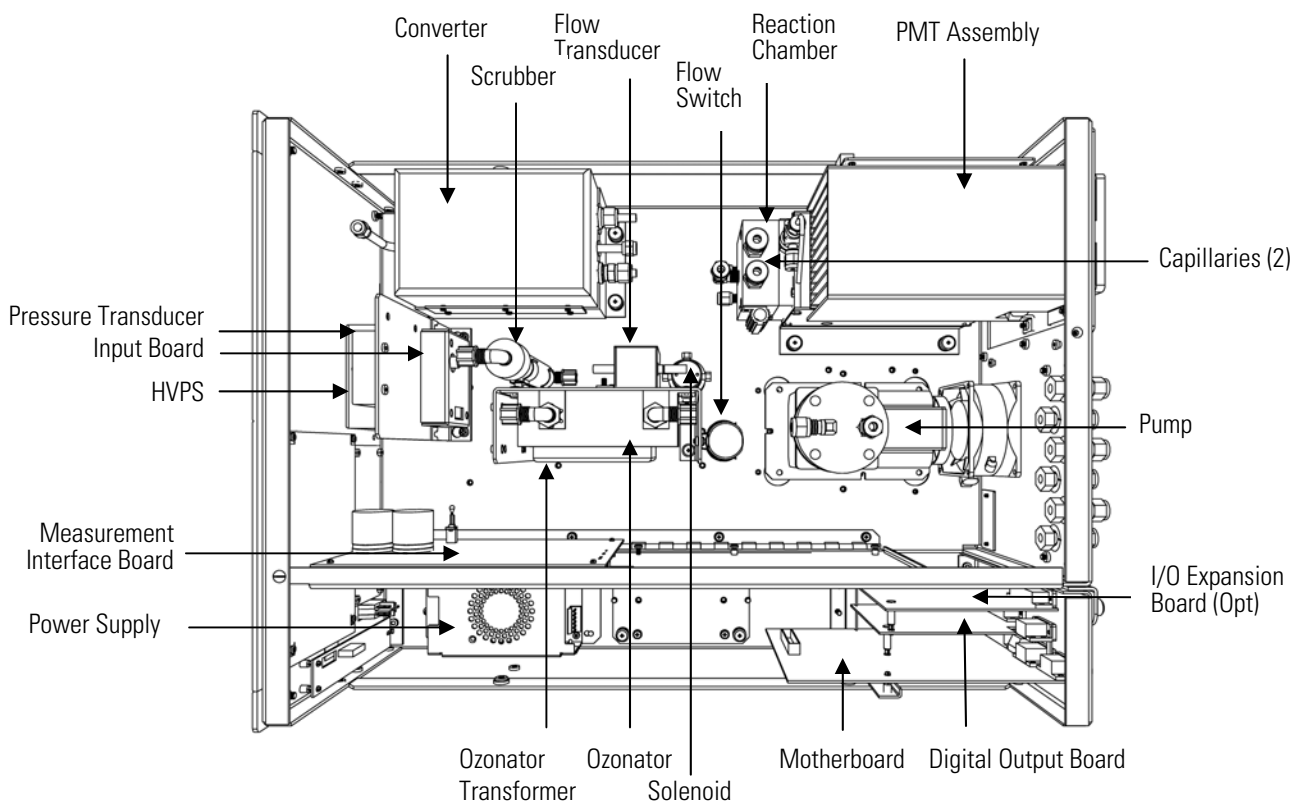

Figure 8-1. Hardware Components

NO₂-to-NO Converter

The NO₂-to-NO converter heats molybdenum to approximately 325 °C in order to convert and detect NO₂. The converter consists of an insulated housing, heater, replaceable cartridge, and a type K thermocouple sensor.

Mode Solenoid

The mode solenoid valve switches analyzer operation between the NO mode and NO_x mode. It routes the ambient air sample either through the reaction chamber (NO mode) or through the NO₂-to-NO converter and then to the reaction chamber (NO_x mode).

Reaction Chamber

The reaction chamber is where the sample reacts with ozone and produces excited NO₂ that gives off a photon of energy when it decays.

The reaction chamber is heated and controlled to approximately 50 °C in order to ensure the greatest instrument stability. The sample and ozone flow capillaries and a thermistor sensor are also housed in/on the reaction chamber assembly.

Optical Filter The optical filter housed in the reaction chamber limits the spectral region viewed by the detector and eliminates possible interferences due to other chemiluminescent reactions.

Pressure Transducer The pressure transducer measures the reaction chamber pressure.

Sample Flow Sensor The sample flow sensor located at the reaction chamber inlet measures the sample flow into the reaction chamber.

Ozonator The Ozonator generates the necessary ozone concentration required for the chemiluminescent reaction. The ozone reacts with the NO in the ambient air sample to produce the electronically excited NO₂ molecules.

Ozonator Flow Switch The ozonator flow switch located at the ozonator inlet completes an electrical safety circuit when air flows through the sensor to the ozonator. If airflow stops, the flow sensor breaks the electrical circuit to the ozonator and shuts it off to prevent the ozonator from overheating.

Photomultiplier Tube The Photomultiplier tube (PMT) provides the infrared sensitivity required to detect the NO₂ luminescence resulting from the reaction of the ozone with the ambient air sample.

Optical energy from the reaction is converted to an electrical signal by the PMT and sent to the input board that transmits it to the processor.

Photomultiplier Tube Cooler The thermoelectric PMT cooler reduces the PMT temperature to approximately -3 °C to minimize dark current and increase instrument sensitivity. The cooler helps to increase zero and span stability over a wide ambient temperature range. The cooler housing also shields the PMT from external electrical and optical interferences.

Pump The vacuum pump draws the reacted gasses out of the reaction chamber.

Sample Capillary The sample capillary along with the pump is used to control flow in the sample line.

Dry Air Capillary

The dry air capillary along with the pump is used to control flow in the dry air line.

Software

The processor software tasks are organized into four areas:

- Instrument Control
- Monitoring Signals
- Measurement Calculations
- Output Communication

Instrument Control

Low-level embedded processors are used to control the various functions on the boards, such as analog and digital I/O and heater control. These processors are controlled over a serial interface with a single high-level processor that also controls the front-panel user interface. The low-level processors all run a common piece of firmware that is bundled with the high-level firmware and loaded on power-up if a different version is detected.

Each board has a specific address that is used to identify to the firmware what functions are supported on that board. This address is also used for the communications between the low-level processors and the high-level processor.

Every tenth of a second the frequency counters, analog I/O, and digital I/O are read and written to by the low-level processor. The counters are accumulated over the past second and the analog inputs are averaged over that second. The high-level processor polls the low-level processors once per second to exchange the measurement and control data.

Monitoring Signals

Signals are gathered from the low-level processors once per second, and then processed by the high-level processor to produce the final measurement values. The one-second accumulated counts representing the NO/NO_x are accumulated and reported for the user-specified averaging time. If this averaging time is greater than ten seconds, the measurement is reported every 10 seconds. The one-second average of the other analog inputs are reported directly (no additional signal conditioning is performed by the high-level processor).

In auto mode, every ten seconds the NO/NO_x solenoid switches and the processor waits three seconds for the reaction chamber to flush and

stabilize. After those three seconds, it accumulates the signal counts for seven seconds before again switching the solenoid.

Measurement Calculations

The calculation of the NO and NO_x concentrations is lengthy and uses the high-level processor to provide the most accurate readings. The calculation begins by subtracting the appropriate electronic offset from the seven-second count accumulation. Following this correction, the raw accumulated counts are scaled according to the gain setting of the input board.

Next, the uncorrected NO and NO_x values are determined according to a unique averaging algorithm which minimizes errors resulting from rapidly changing gas concentrations. This algorithm results in NO and NO_x values which are stored in RAM in a circular buffer that holds all the ten second data from the previous five minutes. This data is averaged over the selected time interval, which can be any multiple of ten between 10 and 300 (the manual modes have additional intervals of 1, 2, and 5 seconds).

The background values for NO and NO_x, which are corrected for temperature, are subtracted from their respective averages. The NO reading is corrected by the stored span factor and by the temperature factor. The NO_x reading is partially corrected by the span factor, temperature factor, and balance factor. The corrected NO value is subtracted from the partially corrected NO_x value to yield an uncorrected NO₂ value. The NO₂ value is then corrected for converter efficiency to give a corrected NO₂ reading. Finally, the corrected NO₂ reading is added to the corrected NO reading to yield a fully corrected NO_x value.

Output Communication

The front panel display, serial and Ethernet data ports, and analog outputs are the means of communicating the results of the above calculations. The front panel display presents the NO, NO₂, and NO_x concentrations simultaneously. The display is updated every 1-10 seconds, depending on the averaging time.

The analog output ranges are user selectable via software. The analog outputs are defaulted based on the measurement range. The defaults are calculated by dividing the data values by the full-scale range for each of the three parameters and then multiplying each result by the user-selected output range. Negative concentrations can be represented as long as they are within -5% of full-scale. The zero and span values may be set by the user to any desired value.

Electronics

All electronics operate from a universal switching supply, which is capable of auto-sensing the input voltage and working over the entire operating range.

Internal pumps and heaters all operate on 110VAC. An optional transformer is required if operating on the 210-250VAC or 90-110VAC ranges.

An on/off switch controls all power to the instrument, and is accessible on the front panel.

Motherboard

The motherboard contains the main processor, power supplies, a sub-processor and serves as the communication hub for the instrument. The motherboard receives operator inputs from the front panel mounted function key panel and/or over I/O connections on the rear panel and sends commands to the other boards to control the functions of the instrument and to collect measurement and diagnostic information. The motherboard outputs instrument status and measurement data to the front-panel mounted graphics display and to the rear-panel I/O. The motherboard also contains I/O circuitry and the associated connector to monitor external digital status lines and to output analog voltages that represent the measurement data. Connectors located on the motherboard include:

External Connectors

External connectors include:

- External Accessory
- RS-232/485 Communications (two connectors)
- Ethernet Communications
- I/O connector with Power Fail Relay, 16 Digital Inputs, and 6 Analog Voltage Outputs.

Internal Connectors

Internal connectors include:

- Function key panel and Display
- Measurement Interface Board Data
- I/O Expansion Board Data
- Digital Output Board
- AC distribution

Measurement Interface Board

The measurement interface board serves as a central connection area for all measurement electronics in the instrument. It contains power supplies and interface circuitry for sensors and control devices in the measurement system. It sends status data to the motherboard and receives control signals from the motherboard.

Measurement Interface Board Connectors

Connectors located on the measurement interface board include:

- Data communication with the motherboard
- 24V and 120VAC power supply inputs
- Fans and solenoid outputs
- Cooler control
- 120VAC outputs for the pump and temperature control board
- Ozonator
- Flow and pressure sensors
- Ambient temperature sensor
- Temperature control board
- PMT high voltage supply
- Measurement input board
- Permeation oven option

Flow Sensor Assembly

The flow sensor assembly consists of a board containing an instrumentation amplifier and a flow transducer with input and output gas fittings. The flow transducer output is produced by measuring the pressure difference across a precision orifice. This unit is used for measuring the flow of sample gas in the measurement system.

Pressure Sensor Assembly

The pressure sensor assembly consists of a board containing an instrumentation amplifier and a pressure transducer with a gas input fitting. The pressure transducer output is produced by measuring the pressure difference between the sample gas pressure and ambient air pressure.

Temperature Control Board

The temperature control board regulates and sets the temperature of the reaction chamber and converter.

The reaction chamber temperature is measured with a thermistor. The voltage across the thermistor is fed to the main processor for use in calculating and displaying the reaction chamber temperature. The voltage across the thermistor is also compared to a set-point voltage and used to control that the reaction chamber heaters to maintain a constant temperature of 50 °C. Protective circuitry prevents over heating in the event of broken wires to the thermistor.

The converter temperature is measured by a conditioned thermocouple signal and fed back to the main processor to be used to display and control the converter temperature. The temperature control board receives control signals from the main processor software to control the converter heater to the desired set point. Protective circuitry prevents over heating in the event of broken wires to the thermocouple or processor faults.

PMT Power Supply Assembly

The PMT power supply produces high voltage to operate the photo multiplier tube used in the measurement system. The output voltage is adjustable from approximately 600 to 1200 volts under software control.

Input Board Assembly

The input board accepts the current signal from the PMT and converts it to a voltage, which is scaled by a factor of approximately 1, 10, or 100 depending on the full-scale range of the NO channel. The scaled voltage signal is converted to a frequency and sent to the microprocessor.

The input board includes a test signal that can be activated under software control. The test signal is injected at the first stage of the input board in parallel with the PMT input. This allows the input board and the connection to the processor system to be tested and calibrated without using the PMT.

Digital Output Board

The digital output board connects to the motherboard and provides solenoid driver outputs and relay contact outputs to a connector located on the rear panel of the instrument. Ten relay contacts normally open (with power off) are provided which are electrically isolated from each other. Eight solenoid driver outputs (open collector) are provided along with a corresponding +24VDC supply pin on the connector.

I/O Expansion Board (Optional)

The I/O expansion board connects to the motherboard and adds the capability to input external analog voltage inputs and to output analog currents via a connector located on the rear panel of the instrument. It contains local power supplies, a DC/DC isolator supply, a sub-processor and analog circuits. Eight analog voltage inputs are provided with an input

voltage range of 0V to 10VDC. Six current outputs are provided with a normal operating range of 0 to 20 mA.

Front Panel Connector Board

The front panel connector board interfaces between the motherboard and the front panel mounted function key panel and Graphics display. It serves as central location to tie the three connectors required for the function key panel, the graphics display control lines, and the graphics display backlight to a single ribbon cable extending back to the motherboard. This board also includes signal buffers for the graphics display control signals and a high voltage power supply for the graphics display backlight.

I/O Components

External I/O is driven from a generic bus that is capable of controlling the following devices:

- Analog output (voltage and current)
- Analog input (voltage)
- Digital output (TTL levels)
- Digital input (TTL levels)

Note The instrument has spare solenoid valve drivers and I/O support for future expansion. ▲

Analog Voltage Outputs

The instrument provides six analog voltage outputs. Each may be software configured for any one of the following ranges, while maintaining a minimum resolution of 12 bits:

- 0-100mV
- 0-1V
- 0-5V
- 0-10V

The user can calibrate each analog output zero and span point through the firmware. At least 5% of full-scale over and under range are also supported, but may be overridden in the firmware, if required.

The analog outputs may be assigned to any measurement or diagnostic channel with a user-defined range in the units of the selected parameter. The voltage outputs are independent of the current outputs.

Analog Current Outputs (Optional)

The optional I/O Expansion board includes six isolated current outputs. These are software configured for any one of the following ranges, while maintaining a minimum resolution of 11 bits:

- 0-20 mA
- 4-20 mA

The user can calibrate each analog output zero and span point through firmware. At least 5% of full-scale over and under range are also supported, but may be overridden in the firmware, if required.

The analog outputs may be assigned to any measurement or diagnostic channel with a user-defined range in the units of the selected parameter. The current outputs are independent of the voltage outputs. The current outputs are isolated from the instrument power and ground, but they share a common return line (Isolated GND).

Analog Voltage Inputs (Optional)

Eight analog voltage inputs are used to gather measurement data from third-party devices. The user may assign a label, unit, and a conversion table (2 to 10 points). Each point in the conversion table consists of an analog input voltage value (0-10.5 V) and a corresponding user-defined reading value. Only two points are necessary for linear inputs, however a larger number of points may be used to approximate non-linear inputs. All voltage inputs have a resolution of 12 bits over the range of 0 to 10.5 volts.

Digital Relay Outputs

The instrument includes one power fail relay on motherboard and ten digital output relays on the digital output board. These are reed relays rated for at least 500 mA @ 200VDC.

The power fail relay is Form C (both normally opened and normally closed contacts). All other relays are Form A (normally opened contacts) and are used to provide alarm status and mode information from the analyzer, as well as remote control to other devices, such as for controlling valves during calibration. The user may select what information is sent out each relay and whether the active state is opened or closed.

Digital Inputs

Sixteen digital inputs are available which may be programmed to signal instrument modes and special conditions including:

- NO Measure Mode
- NO_x Measure Mode
- Zero Gas Mode

- Span Gas Mode
- Set Background
- Cal to low span
- Cal to high span
- Analog outputs to zero
- Analog outputs to full-scale

The actual use of these inputs will vary based on analyzer configuration.

The digital inputs are TTL level compatible and are pulled up within the analyzer. The active state can be user defined in firmware.

Serial Ports

Two serial ports allow daisy chaining so that multiple analyzers may be linked using one PC serial port.

The standard bi-directional serial interface can be configured for either RS-232 or RS-485. The serial baud rate is user selectable in firmware for standard speeds from 1200 to 19,200 baud. The user can also set the data bits, parity, and stop bits. The following protocols are supported:

- C-Link
- Modbus Slave
- Geysitech (Bayern-Hessen)
- Streaming Data

The Streaming Data protocol transmits user-selected measurement data via the serial port in real-time for capture by a serial printer, data logger, or PC.

RS-232 Connection

A null modem (crossed) cable is required when connecting the analyzer to an IBM Compatible PC. However, a straight cable (one to one) may be required when connecting the analyzer to other remote devices. As a general rule, when the connector of the host remote device is female, a straight cable is required and when the connector is male, a null modem cable is required.

Data Format:

1200, 2400, 4800, 9600, 19200, 38400, 57600, or 115200 BAUD

7 or 8 data bits

1 or 2 stop bit

No, odd, or even parity

All responses are terminated with a carriage return (hex 0D)

Refer to [Table 8–1](#) for the DB9 connector pin configuration.

Table 8–1. RS-232 DB9 Connector Pin Configurations

DB9 Pin	Function
2	RX
3	TX
7	RTS
8	CTS
5	Ground

RS-485 Connection

The instrument uses a four wire RS-485 configuration with automatic flow control (SD). Refer to [Table 8–2](#) for the DB9 connector pin configuration.

Table 8–2. RS-485 DB9 Connector Pin Configuration

DB9 Pin	Function
2	+ receive
8	- receive
7	+ transmit
3	- transmit
5	ground

Ethernet Connection

An RJ45 connector is used for the 10Mbps Ethernet connection supporting TCP/IP communications via standard IPV4 addressing. The IP address may be configured for static addressing or dynamic addressing (set using a DHCP server).

Any serial port protocols may be accessed over Ethernet in addition to the serial port. Up to three simultaneous connections are allowed per protocol.

External Accessory Connector

The external accessory connector is not used in the Model 42*i* analyzer.

This port is used in other models to communicate with smart external devices that may be mounted hundreds of feet from the analyzer using an RS-485 electrical interface.

Chapter 9

Optional Equipment

The Model 42*i* is available with the following options:

- “Internal Zero/Span and Sample Valves” on page 9-1
- “Internal Permeation Span Source” on page 9-2
- “Ozonator Permeation Dryer” on page 9-10
- “Sample Permeation Dryer” on page 9-10
- “Lag Volume” on page 9-10
- “Ammonia Scrubber” on page 9-12
- “Teflon Particulate Filter” on page 9-12
- “Ozone Particulate Filter” on page 9-13
- “NO₂-to-NO Converter” on page 9-13
- “I/O Expansion Board Assembly” on page 9-13
- “Terminal Block and Cable Kits” on page 9-13
- “Cables” on page 9-14
- “Mounting Options” on page 9-15

Internal Zero/Span and Sample Valves

With the zero/span assembly option, a source of span gas is connected to the SPAN port and a source of zero air is connected to the ZERO port as shown in [Figure 9–1](#). Zero and span gas should be supplied at atmospheric pressure. It may be necessary to use an atmospheric dump bypass plumbing arrangement to accomplish this.

For more information, refer to the “[Installation](#)” chapter and the “[Operation](#)” chapter.

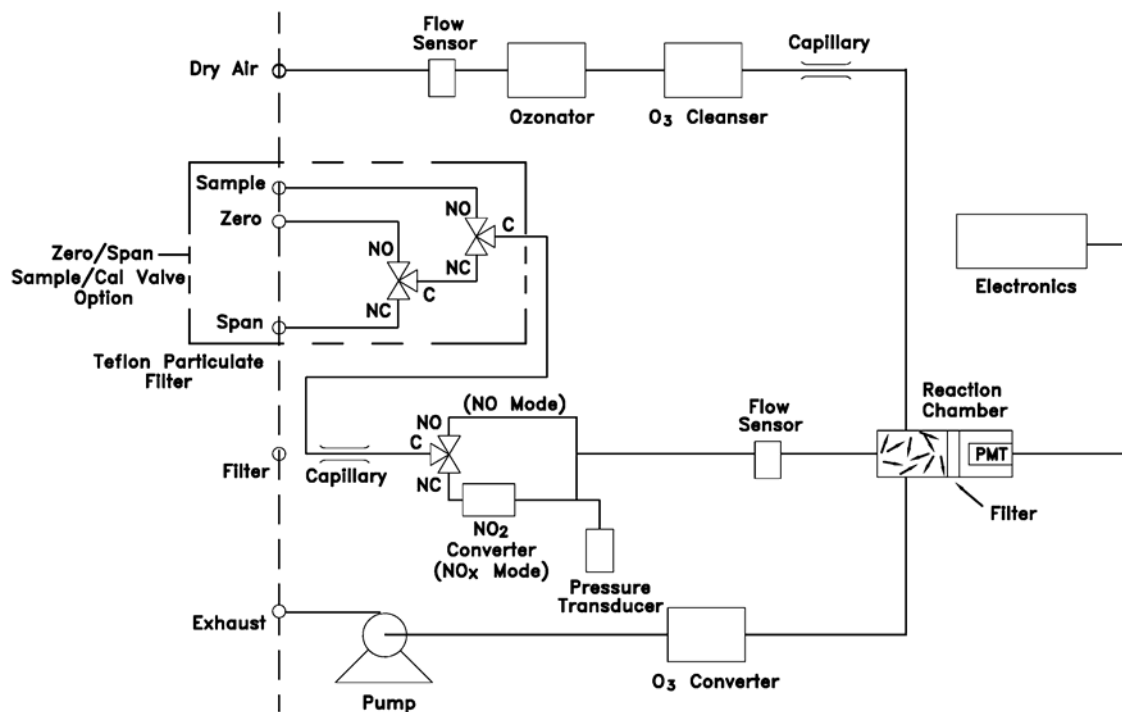

Figure 9–1. Flow Diagram, Zero/Span Option

Internal Permeation Span Source

The Internal Permeation Span Source option is designed to provide a simple source of span gas. It is intended as a quick, convenient check to be used between zero and span calibrations for determining instrument malfunction or drift. Because this option does not precisely control dilution gas flow, it should not be used as a basis for instrument zero and span adjustments, calibration updates, or adjustment of ambient data.

Whenever there is an indication of instrument drift or malfunction, a full zero and multipoint calibration (Level 1) should be performed prior to corrective action. For further information on zero, span and calibration of air pollution monitors, refer to Section 2.0.9 of the US EPA's *Quality Assurance Handbook for Air Pollution Measurement Systems (Volume II)*.

Figure 9–2 shows how this option is integrated with the Model 42i components. Energizing the sample valve V1 shuts off the sample flow and permits the flow of zero air for analysis. When valves V1 and V2 are energized, the flow of zero air mixes with air containing NO₂ from the permeation oven. This mode of operation provides a single point span check.

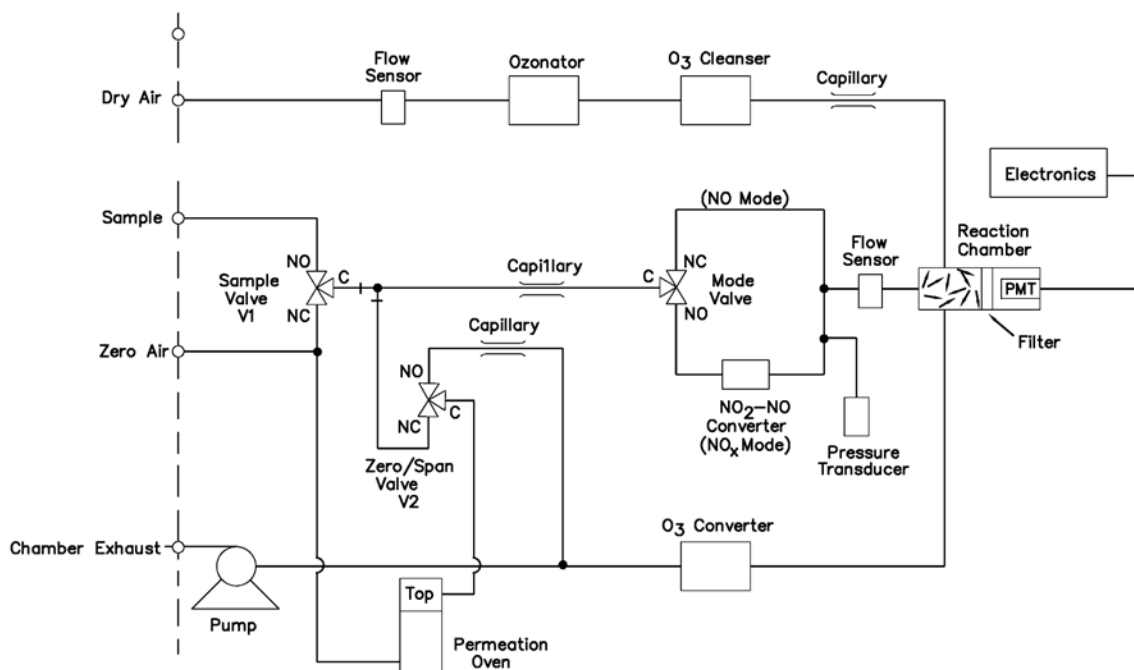

Figure 9–2. Flow Diagram, Internal Permeation with Zero/Span Valve

Permeation Tube Installation

Use the following procedure to install the optional permeation tube.

1. Remove the oven cover.
2. Remove the glass chamber assembly by loosening the white plastic retaining collar, loosening (not removing) the knurled screw, and gently pulling the assembly upward. Completely remove the oven.
3. Separate the glass chamber from the top assembly by twisting and gently pulling the glass away from the top.

Note Keep the glass clean when handling it. ▲

4. Place the permeation tube(s) in the glass chamber.
5. Attach the glass chamber to the top assembly by gently pushing the two together with a slight twisting motion.

6. Replace the glass chamber assembly into the oven until the top of the assembly is flush or slightly below the top of the oven.



Equipment Damage Do not use tools to tighten the knurled screw in the following step. ▲

7. Tighten the knurled screw finger tight. Do not use tools to tighten.
8. Tighten the white plastic retaining collar.
9. Replace the oven cover being careful to place the tubing and wiring into the cover slot.

Computation of Concentrations

The computation of NO₂ output level is shown in the following information. Note that is assumed that all devices are properly calibrated and that all flows are corrected to 25 °C and 1 atm.

Permeation Tube:

$$Output (ppm) = \frac{(R)(K)}{Q_o}$$

Where:

R = permeation rate in ng/min

Q₀ = flow rate of gas (scc/min) during span mode

K = constant for the specific permeant = 24.45 / MW









MW = molecular weight

K(NO₂) = 0.532

Oven Installation and Configuration

Use the following procedure to install and configure the permeation oven.

1. Physically install the permeation oven and valves into the instrument and connect the cables and plumbing.
2. From the Perm Oven Settings menu in the Service menu, select **Perm Oven Selection**, then select **45 °C**.

3. Remove the thermistor from POJ1 on the measurement interface board.
4. Connect a resistance of approximately 4.2 K Ω across pins 1 and 2 of POJ1.
5. Go to the Factory Cal Gas Therm menu from the Perm Oven Settings menu in the Service menu. Select **Low Point**, enter the exact value of the resistor and press  to calibrate the low resistance point.
6. Press  to return to the Factory Cal Gas Therm menu.
7. Connect a resistance of approximately 5 K Ω across pins 1 and 2 of POJ1.
8. Go to the High Point screen, enter the exact value of the resistor and press  to calibrate the high resistance point.
9. Press  to return to the Factory Cal Gas Therm menu.
10. Remove resistor from POJ1 and re-attach the gas thermistor.
11. Connect a resistance of approximately 4.2 K Ω across pins 3 and 4 of POJ3.
12. Go to the Factory Cal Oven Therm menu from the Perm Oven Settings menu in the Service menu. Select **Low Point**, enter the exact value of the resistor and press  to calibrate the low resistance point.
13. Press  to return to the Factory Cal Oven Therm menu.
14. Connect a resistance of approximately 5 K Ω across pins 3 and 4 of POJ3.
15. Go to the High Point screen, enter the exact value of the resistor and press  to calibrate the high resistance point.
16. Press  to return to the Factory Cal Oven Therm menu.

17. Remove resistor from POJ3 and re-attach the permeation oven.

18. Perform a thermistor calibration using the “Permeation Tube Oven Calibration” procedure that follows.

Permeation Tube Oven Calibration

There are two general approaches that can be used to calibrate the permeation tube oven. The first is to calibrate the temperature indicator very accurately (to better than 0.02 °C) and to use a permeation tube whose weight loss has been previously determined at that temperature.

Note An error of approximately 0.1 °C corresponds to an error of 1% in release rate. ▲

The second approach is to note that the thermistors used to measure temperature are interchangeable to better than ±0.2 °C. Thus a 1% resistor of the proper value (4.369 KΩ for 45 °C) can be used to set the span on the measurement interface board. The release rate for the permeation tube is then determined by weight loss in the actual oven being used.

Setting Perm Oven Temperature

You can use either of the two calibration methods presented here. One method involves performing the “Setting Perm Oven Temperature” procedure and then continuing with the “Setting Temperature with Water Bath” procedure.

Alternatively, you can perform the “Setting Perm Oven Temperature” procedure and then continue with the “Setting Temperature with Known Resistance” procedure.

In either case, use the following procedure for setting the perm oven temperature.

1. Unplug POJ3 from the measurement interface board. Place a 4.369 KΩ resistor across pins 3 and 4 on the board.
2. In the Main Menu, choose Service > Perm Oven Settings > **Cal Oven Thermistor**.

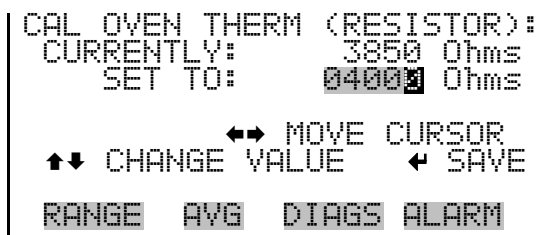

3. Enter the exact value of the attached resistor and press to save the offset.
4. Press to return to the Permeation Oven menu.
5. Remove the resistor and re-attach the permeation oven to POJ3.

Setting Temperature with Water Bath

Use the following procedure for setting the measure temperature with water bath.

1. Remove the thermistor from the permeation tube oven, but leave the thermistor connected to the measurement interface board. Insert the thermistor into the water bath next to an NIST traceable thermometer (if necessary, use an extension cable to reach).
2. Turn on the power to the water bath. Using an NIST traceable thermometer with a resolution of ± 0.01 °C, adjust the water bath to 45 °C.
3. In the Main Menu, choose Service > Perm Oven Settings > Cal Gas Thermistor > **Water Bath**.

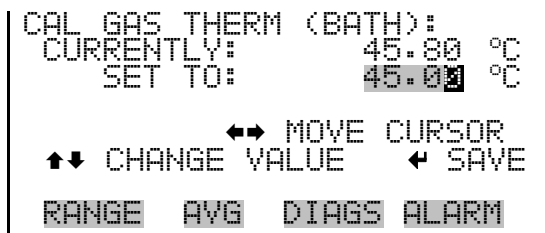

4. Enter the thermistor temperature from the thermometer and press .

Optional Equipment

Internal Permeation Span Source

5. Remove the thermistor from the water bath, dry, and replace into the permeation tube oven.
6. Make sure the source of zero air is connected to the ZERO bulkhead on the rear panel.
7. Wait for the permeation gas temperature reading to stabilize.

Setting Temperature with Known Resistance

Use the following procedure to set the gas temperature with an accurate known resistance.

1. Remove the thermistor from POJ1 on the measurement interface board.
2. Connect a 4.369 K Ω resistor across pins 1 and 2 of POJ1 (use a resistance substitution box and an accurate meter, if necessary).
3. In the Main Menu, choose Service > Perm Oven Settings > Cal Gas Thermistor > **Known Resistor**.

```
CAL GAS THERM (RESISTOR):  
CURRENTLY:      3850 Ohms  
SET TO:         04000 Ohms  
  
      ←→ MOVE CURSOR  
↑↓ CHANGE VALUE  ← SAVE  
  
RANGE  AVG  DIAGS  ALARM
```

4. Enter the exact value of the attached resistor and press  to save the offset.
5. Remove the resistor and reconnect the gas thermistor.
6. Make sure the source of zero air is connected to the ZERO bulkhead on the rear panel.
7. Wait for the permeation gas temperature reading to stabilize.

Determining Permeation Rate by Weight Loss

Use the following procedure to determine the permeation rate by weight loss.

1. Make sure the oven has been calibrated as described in the “Permeation Tube Oven Calibration” procedure described previously.
2. Insert the permeation tube carefully. Do not touch with fingers.
3. Turn on the instrument.
4. Wait 24-48 hours for the permeation tube to stabilize.
5. Carefully remove the permeation tube from the oven and weigh to an accuracy of 0.1mg. Perform this measurement as quickly as possible.
6. Replace the permeation tube into the oven of the instrument.
7. Repeat Steps 5 and 6 after two weeks.
8. Compute the weight loss of the permeation tube from the values determined in Steps 5 through 7.
9. Repeat Steps 5 through 8 until the weight loss has been determined to a precision of 1-2%.
10. For the most accurate work, use the permeation tube in the same oven that was used to determine the weight loss of permeation tube.

Determining Release Rate by Transfer Standard

Use the following procedure to determine the release rate by transfer standard.

1. Make sure the oven has been calibrated as described in the “[Permeation Tube Oven Calibration](#)” procedure described previously. Also make sure that the Transfer Standard has been properly calibrated.
2. Determine the permeation rate for the permeation tube in the Transfer Standard, or install a certified permeation tube.

Optional Equipment

Ozonator Permeation Dryer

3. Allow the permeation tubes in both the 42*i* and the Transfer Standard to stabilize for at least 24-48 hours.
4. Carefully calibrate the 42*i* using the Transfer Standard. The output of the Transfer Standard should be connected to the SAMPLE bulkhead on the rear panel of the 42*i*.
5. Switch the calibrated 42*i* into the span mode.
6. Measure the flow rate into the ZERO bulkhead on the rear panel of the 42*i*. Be sure that the source of zero air is connected. Note the flow and measured NO₂ concentration.
7. From the flow and measured concentration, compute the permeation tube release rate.

Ozonator Permeation Dryer

The permeation dryer minimizes routine maintenance procedures by providing a continuous stream of dry air to the ozonator (using the selective water permeation characteristics of the dryer). With the permeation dryer option, it is not necessary to constantly replenish the ozonator air-drying column as in the standard instrument.

Sample Permeation Dryer

The sample permeation dryer option is used when there may be widely varying levels of ambient water vapor present. The dryer stabilizes the moisture content of the sample stream providing a constant dew-point at the outlet over a wide range of inlet ambient moisture levels.

A secondary benefit of the sample dryer option is its ability to remove ambient levels of ammonia (NH₃) from the sample stream.

Lag Volume

The Model 42*i* is available with the following Lag Volume option.

Principle of Operation

The Model 42*i* is based on the principle that nitric oxide (NO) and ozone react to produce a characteristic luminescence with an intensity linearly proportional to the NO concentration. Infrared light emission results when electronically excited NO₂ molecules decay to lower energy states.

Specifically,



Nitrogen dioxide (NO₂) must first be transformed into NO before it can be measured using the chemiluminescent reaction. NO₂ is converted to NO by a molybdenum NO₂-to-NO converter heated to about 325 °C.

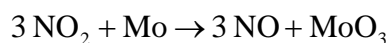

The ambient air sample enters the Model 42*i* through an inline Teflon® particulate filter, through a flow control capillary, and then splits between the NO and the NO_x channel. In the NO channel, the split sample is directed to the common port of the three-way solenoid valve. The sample is then routed either to the inlet tee of the reaction chamber or joins the exhaust of the reaction chamber. In the NO_x channel, the split sample is directed to the common port of a second three-way solenoid valve after having passed through the NO₂ converter and a lag volume, as shown in [Figure 9–3](#). The "delayed" sample is then routed identically to the NO channel.

The two channels operate 180° out of phase, that is, when the instrument is monitoring NO, the NO_x sample is being bypassed, and when the instrument is monitoring NO_x, the NO sample is being bypassed. The solenoids switch every 5 seconds and the size of the lag volume has been chosen so the same original sample is being monitored by both the NO and the NO_x channels. In this way, any positive or negative errors in the NO₂ signal (determined by the difference between the NO_x and NO readings) is minimized - especially in a situation where the sample is changing rapidly, e.g., an urban traffic environment.

The Model 42*i* stores the NO signal obtained during the first half of the solenoid cycle, determines the NO_x signal during the second half of the solenoid cycle, and then calculates and updates a NO, NO₂, and NO_x signal every 10 seconds. Averages are available then from 10 to 300 seconds.

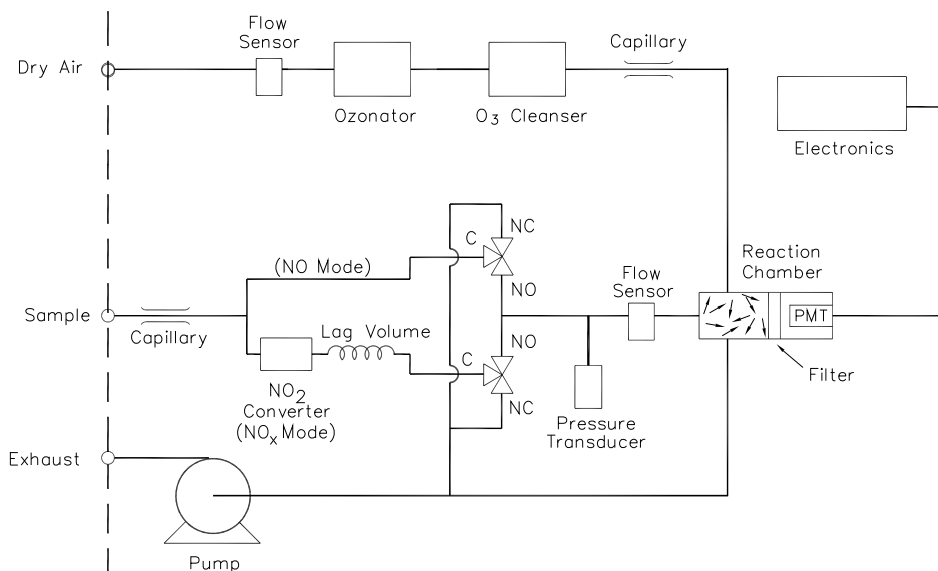

Figure 9-3. Flow Diagram, Lag Volume

Lag Volume Test Use the following procedure to test the Model 42*i* with lag volume option.

1. Set the NO range to 1,000 ppb and the averaging time to 10 seconds.
2. Introduce approximately 800 ppb NO into the Model 42*i*. Wait for a stable reading and then record the NO₂ reading. Next, introduce zero air into the Model 42*i*. Wait until the instrument reads close to zero (<3 ppb). Repeat the above procedure two more times. Take the average of the three NO₂ readings. The average NO₂ reading should be less than 50 ppb.

Ammonia Scrubber

The ammonia scrubber is mounted internally and removes ammonia from the sample air.

Teflon Particulate Filter

A 5-10 micron pore size, two-inch diameter Teflon® element is available for the Model 42*i*. This filter should be installed just prior to the SAMPLE bulkhead. When using a filter, all calibrations and span checks must be performed through the filter.

Ozone Particulate Filter

The ozone particulate filter minimizes the potential for contamination of the capillary and reaction chamber by trapping any particulate matter before passing through the capillary and reaction chamber.

NO₂-to-NO Converter

The Model 42*i* includes a Molybdenum NO₂-to-NO converter as standard equipment. A stainless steel converter is available as an option.

I/O Expansion Board Assembly

The I/O expansion board provides six analog current output channels (0-20 mA or 4-20 mA) and eight analog voltage inputs (0-10V). The DB25 connector on the rear panel provides the interface for these inputs and outputs.

25 Pin Terminal Board Assembly

The 25-pin terminal board assembly is included with the I/O expansion board. Refer “[Terminal Board PCB Assemblies](#)” in the “[Installation](#)” chapter for information on attaching the cable to the connector board. For associated part numbers, refer to “[External Device Connection Components](#)” on page 7-6.

Terminal Block and Cable Kits

The optional terminal block and cable kits provide a convenient way to connect devices to the instrument. These kits break out the signals on the rear panel connector to individual numbered terminals.

Two types of terminal block and cable kits are available. One kit is for the DB37 connectors and can be used for either the analog output connector or the relay output connector. The other kit is for the DB25 connector and can be used for the optional I/O expansion board. For associated part numbers, refer to “[External Device Connection Components](#)” on page 7-6.

Each kit consists of:

- one six-foot cable
- one terminal block
- one snap track

Note Supporting all of the connections on units with the optional I/O expansion board requires:

- two DB37 kits
- one DB25 kit

Cables

Table 9–1 identifies the optional individual cables that are available for the instrument and Table 9–2 provides the cable color codes. For associated part numbers, refer to “External Device Connection Components” on page 7-6.

Note Table 9–2 provides the color coding for both 25-pin cables and 37-pin cables. Color codes for pins 1-25 are for 25-pin cables; color codes for pins 1-37 are for 37-pin cables. ▲

Table 9–1. Cable Options

Description	Cable Length
DB37M to open end	Six feet
DB37F to open end	Six feet
DB25M to open end	Six feet
RS-232	Six feet

Table 9–2. Color Codes for 25-Pin and 37-Pin Cables

Pin	Color	Pin	Color
1	BLACK	20	RED/BLACK
2	BROWN	21	ORANGE/BLACK
3	RED	22	YELLOW/BLACK
4	ORANGE	23	GREEN/BLACK
5	YELLOW	24	GRAY/BLACK
6	GREEN	25	PINK/BLACK
7	BLUE	End color codes for 25-pin cables continue for 37-pin cables.	
8	VIOLET	26	PINK/GREEN
9	GRAY	27	PINK/RED
19	WHITE	28	PINK/VIOLET
11	PINK	29	LIGHT BLUE
12	LIGHT GREEN	30	LIGHT BLUE/BROWN
13	BLACK/WHITE	31	LIGHT BLUE/RED
14	BROWN/WHITE	32	LIGHT BLUE/VIOLET
15	RED/WHITE	33	LIGHT BLUE/BLACK

Pin	Color	Pin	Color
16	ORANGE/WHITE	34	GRAY/GREEN
17	GREEN/WHITE	35	GRAY/RED
18	BLUE/WHITE	36	GRAY/VIOLET
19	VIOLET/WHITE	37	LIGHT GREEN/BLACK

Mounting Options

The analyzer can be installed in the configuration described in [Table 9-3](#) and shown in [Figure 9-1](#) through [Figure 9-4](#).

Table 9-3. Mounting Options

Mounting Type	Description
Bench	Positioned on bench, includes mounting feet and front panel side-trim handles.
EIA rack	Mounted in an EIA-style rack, includes mounting slides and front panel EIA-rack mounting handles.
Retrofit rack	Mounted in an EIA-style rack, includes mounting slides and front panel EIA-rack mounting handles. This configuration is intended for direct replacement of a C-series instrument in an existing rack. The rail mounting location is lower on the case and the front mounting screw slots are in non-standard EIA locations.

Optional Equipment
Mounting Options

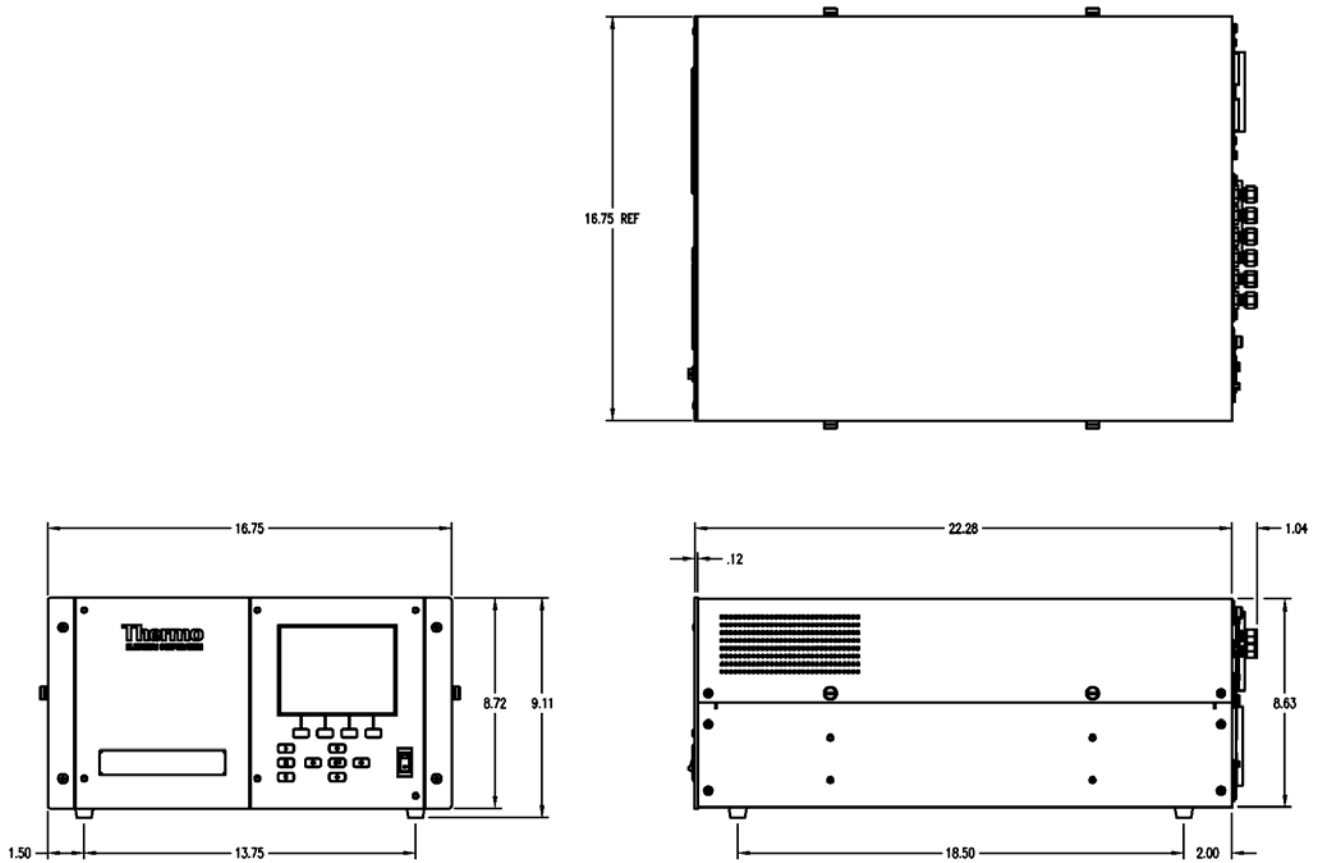

Figure 9–1. Bench Mounting

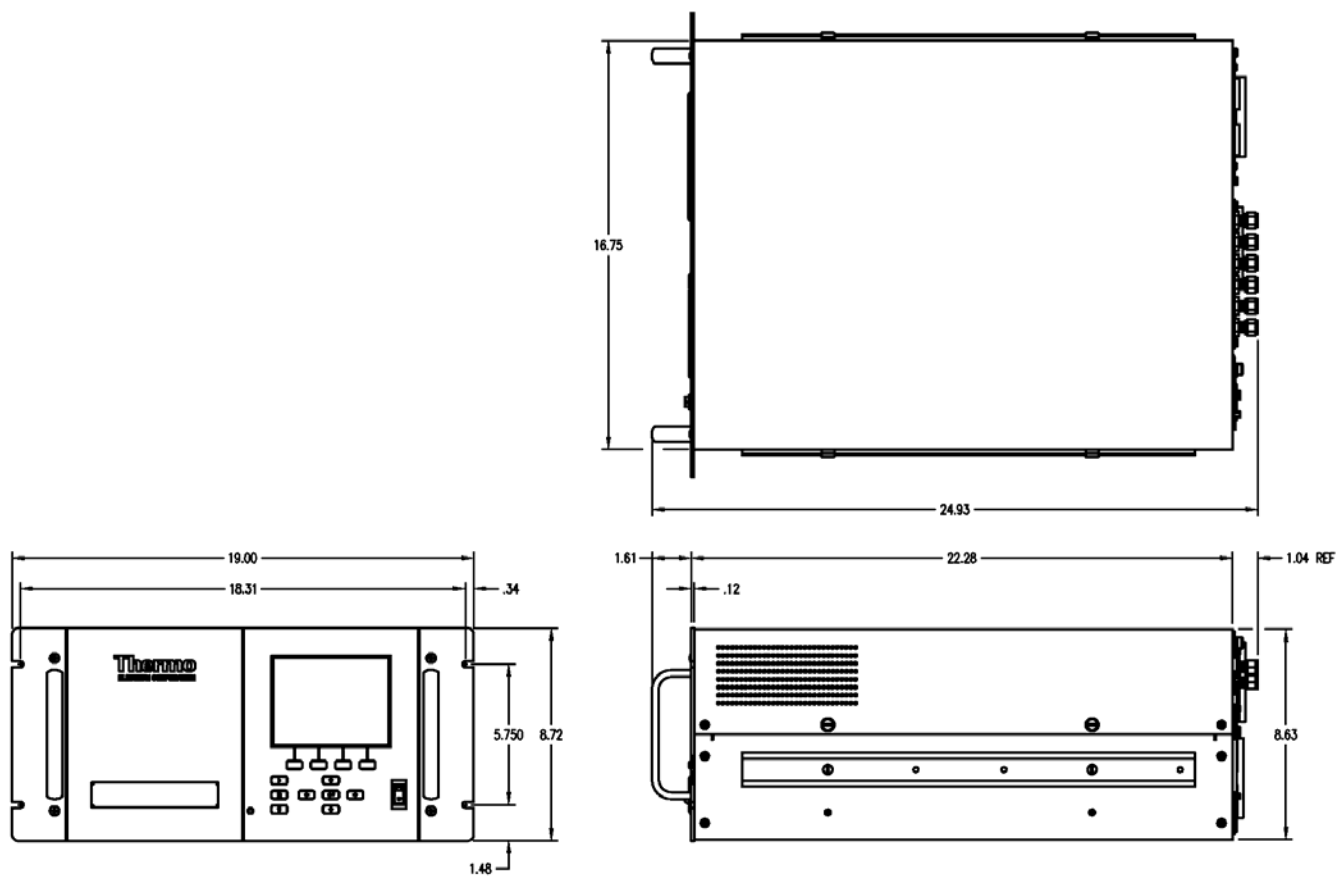

Figure 9–2. EIA Rack Mounting

Optional Equipment
Mounting Options

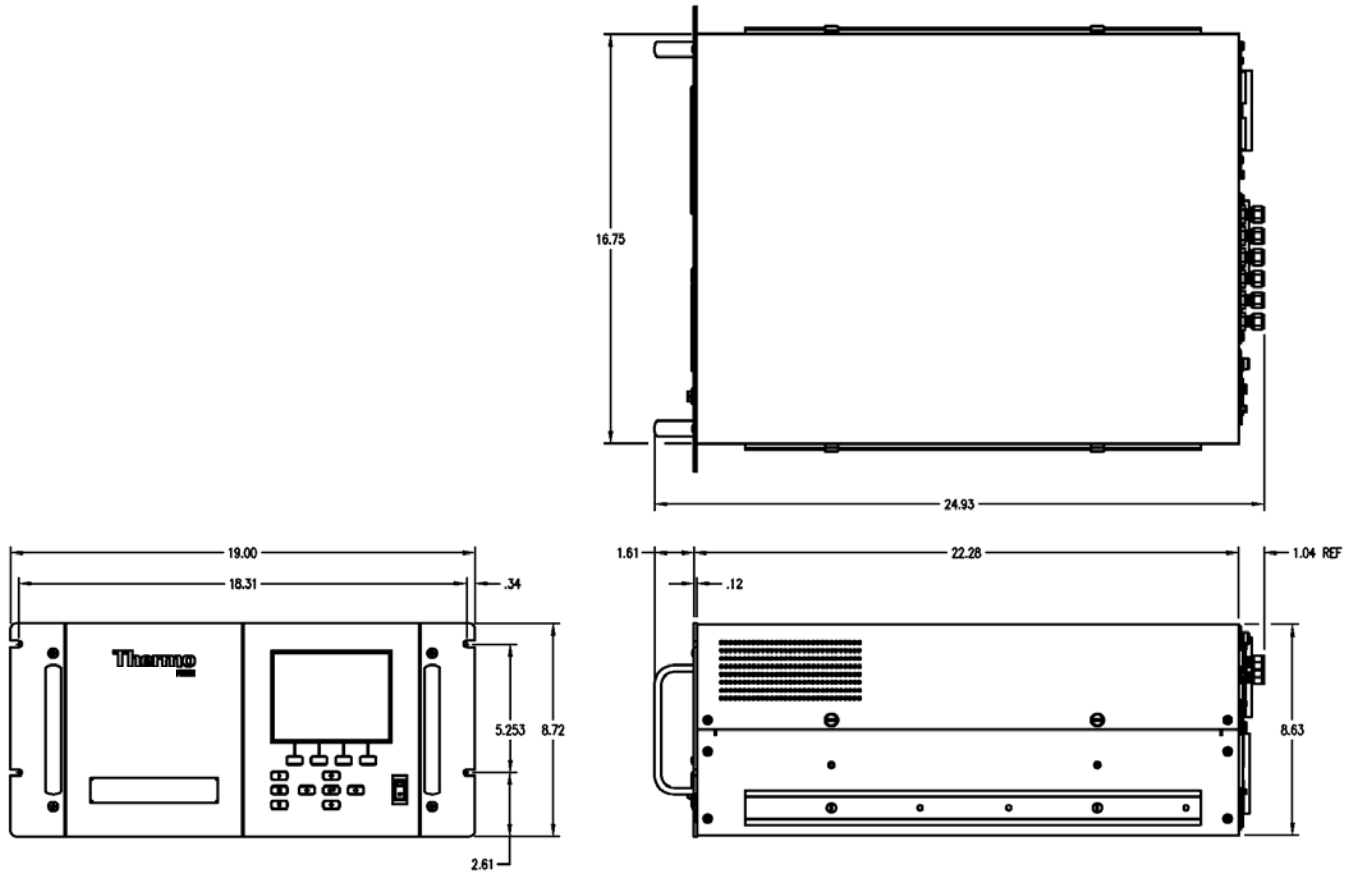

Figure 9-3. Retrofit Rack Mounting

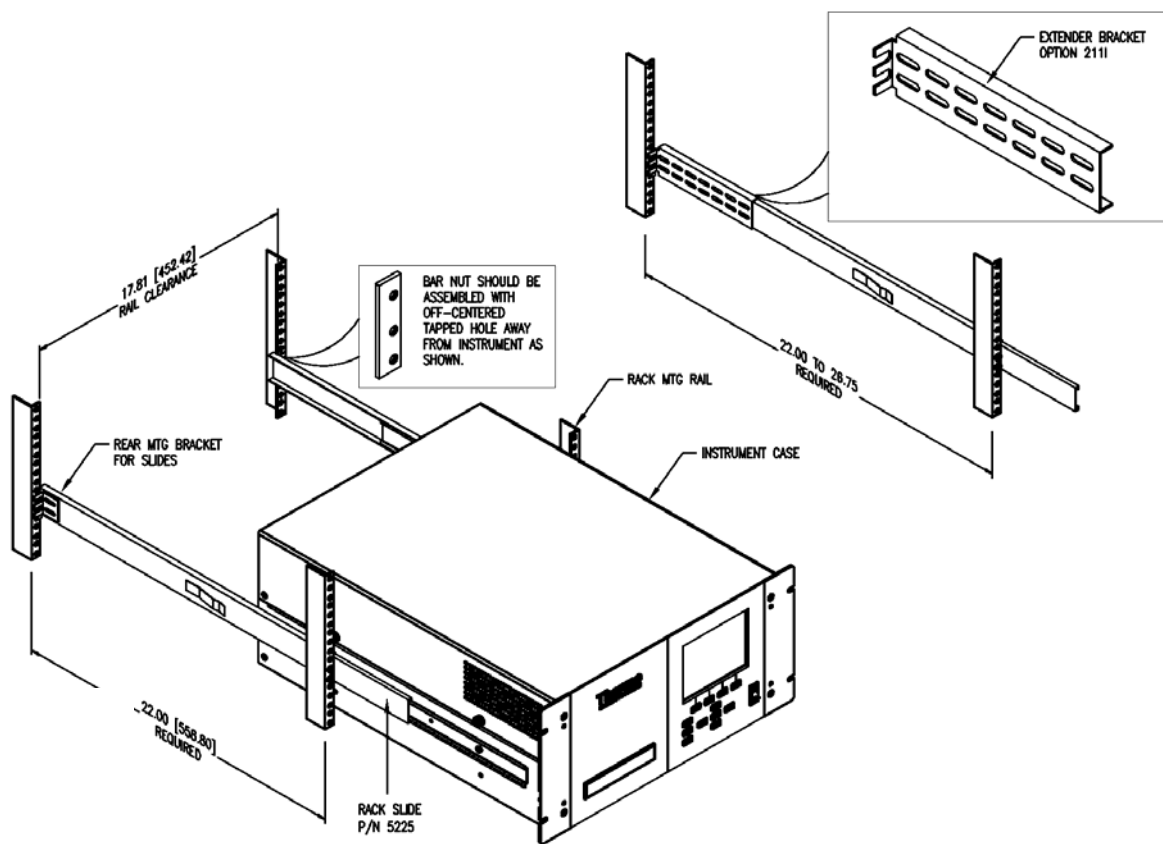

Figure 9-4. Rack Mount Option Assembly

Appendix A

Warranty

Seller warrants that the Products will operate or perform substantially in conformance with Seller's published specifications and be free from defects in material and workmanship, when subjected to normal, proper and intended usage by properly trained personnel, for the period of time set forth in the product documentation, published specifications or package inserts. If a period of time is not specified in Seller's product documentation, published specifications or package inserts, the warranty period shall be one (1) year from the date of shipment to Buyer for equipment and ninety (90) days for all other products (the "Warranty Period"). Seller agrees during the Warranty Period, to repair or replace, at Seller's option, defective Products so as to cause the same to operate in substantial conformance with said published specifications; provided that (a) Buyer shall promptly notify Seller in writing upon the discovery of any defect, which notice shall include the product model and serial number (if applicable) and details of the warranty claim; (b) after Seller's review, Seller will provide Buyer with service data and/or a Return Material Authorization ("RMA"), which may include biohazard decontamination procedures and other product-specific handling instructions; and (c) then, if applicable, Buyer may return the defective Products to Seller with all costs prepaid by Buyer. Replacement parts may be new or refurbished, at the election of Seller. All replaced parts shall become the property of Seller. Shipment to Buyer of repaired or replacement Products shall be made in accordance with the Delivery provisions of the Seller's Terms and Conditions of Sale. Consumables, including but not limited to lamps, fuses, batteries, bulbs and other such expendable items, are expressly excluded from the warranty under this warranty.

Notwithstanding the foregoing, Products supplied by Seller that are obtained by Seller from an original manufacturer or third party supplier are not warranted by Seller, but Seller agrees to assign to Buyer any warranty rights in such Product that Seller may have from the original manufacturer or third party supplier, to the extent such assignment is allowed by such original manufacturer or third party supplier.

In no event shall Seller have any obligation to make repairs, replacements or corrections required, in whole or in part, as the result of (i) normal wear and tear, (ii) accident, disaster or event of force majeure, (iii) misuse, fault or negligence of or by Buyer, (iv) use of the Products in a manner for which

they were not designed, (v) causes external to the Products such as, but not limited to, power failure or electrical power surges, (vi) improper storage and handling of the Products or (vii) use of the Products in combination with equipment or software not supplied by Seller. If Seller determines that Products for which Buyer has requested warranty services are not covered by the warranty hereunder, Buyer shall pay or reimburse Seller for all costs of investigating and responding to such request at Seller's then prevailing time and materials rates. If Seller provides repair services or replacement parts that are not covered by the warranty provided in this warranty, Buyer shall pay Seller therefor at Seller's then prevailing time and materials rates. ANY INSTALLATION, MAINTENANCE, REPAIR, SERVICE, RELOCATION OR ALTERATION TO OR OF, OR OTHER TAMPERING WITH, THE PRODUCTS PERFORMED BY ANY PERSON OR ENTITY OTHER THAN SELLER WITHOUT SELLER'S PRIOR WRITTEN APPROVAL, OR ANY USE OF REPLACEMENT PARTS NOT SUPPLIED BY SELLER, SHALL IMMEDIATELY VOID AND CANCEL ALL WARRANTIES WITH RESPECT TO THE AFFECTED PRODUCTS.

THE OBLIGATIONS CREATED BY THIS WARRANTY STATEMENT TO REPAIR OR REPLACE A DEFECTIVE PRODUCT SHALL BE THE SOLE REMEDY OF BUYER IN THE EVENT OF A DEFECTIVE PRODUCT. EXCEPT AS EXPRESSLY PROVIDED IN THIS WARRANTY STATEMENT, SELLER DISCLAIMS ALL OTHER WARRANTIES, WHETHER EXPRESS OR IMPLIED, ORAL OR WRITTEN, WITH RESPECT TO THE PRODUCTS, INCLUDING WITHOUT LIMITATION ALL IMPLIED WARRANTIES OF MERCHANTABILITY OR FITNESS FOR ANY PARTICULAR PURPOSE. SELLER DOES NOT WARRANT THAT THE PRODUCTS ARE ERROR-FREE OR WILL ACCOMPLISH ANY PARTICULAR RESULT.

Appendix B

C-Link Protocol Commands

This appendix provides a description of the C-Link protocol commands that can be used to remotely control a Model 42*i* analyzer using a host device such as a PC or a datalogger. C-Link protocol may be used over RS-232, RS-485, or Ethernet. C-Link functions can be accessed over Ethernet using TCP/IP port 9880.

Streaming data is sent out the serial port or the Ethernet port on a user-defined periodic basis. Streaming data over Ethernet is only generated when a connection is made on TCP port 9881.

Up to three simultaneous connections per protocol may be made over Ethernet.

For details, see the following topics:

- “[Instrument Identification Number](#)” on page B-1
- “[Commands](#)” on page B-2
- “[Measurements](#)” on page B-10
- “[Alarms](#)” on page B-14
- “[Diagnostics](#)” on page B-18
- “[Datalogging](#)” on page B-19
- “[Calibration](#)” on page B-27
- “[Keys/Display](#)” on page B-30
- “[Measurement Configuration](#)” on page B-35
- “[Hardware Configuration](#)” on page B-39
- “[Communications Configuration](#)” on page B-43
- “[I/O Configuration](#)” on page B-49
- “[Record Layout Definition](#)” on page B-55

Instrument Identification Number

Each command sent to the analyzer over the serial port must begin with the American Standard Code for Information Interchange (ASCII) symbol or byte value equivalent of the instrument's identification number plus 128.

For example, if the instrument ID is set to 25, then each command must begin with the ACSII character code 153 decimal. The analyzer ignores any command that does not begin with its instrument identification number. If the instrument ID is set to 0, then this byte is not required. For more information on changing Instrument ID, see Chapter 3, “Operation”.

Commands

The analyzer must be in the remote mode in order to change instrument parameters via remote. However, the command “set mode remote” can be sent to the analyzer to put it in the remote mode. Report commands (commands that don’t begin with “set”) can be issued either in the remote or local mode. For information on changing modes, see Chapter 3, “Operation”.

The commands can be sent in either uppercase or lowercase characters. Each command must begin with the proper instrument identification number (ASCII) character. The command in the example below begins with the ASCII character code 170 decimal, which directs the command to the Model 42*i*, and is terminated by a carriage return “CR” (ASCII character code 13 decimal).

<ASCII 170>	T	I	M	E	<CR>
-------------	---	---	---	---	------

Many of the commands have two forms. One form reads parameter from the instrument’s memory, and the other writes, or updates, a parameter. The syntax for a write command adds the word “set” in front of the command and provides an argument. Command responses are generally echoed with a data element appended.

Note If the Service Mode is active, C-Link “set” commands are not allowed. This is to prevent parameters from being changed remotely while the unit is being serviced locally. ▲

If an incorrect command is sent, an error message is generated. The list of error responses is shown in Table B–1. The following example sends the incorrect command “set unit ppm” instead of the correct command “set gas unit ppm.”

```
Send:          set unit ppm
Receive:       set unit ppm bad cmd
```

Table B–1. Error Response Messages

Command Response	Description
bad cmd	Command is not recognized
too high	Supplied value is higher than the upper limit
too low	Supplied value is lower than the lower limit
invalid string	Supplied string invalid (typically because a letter was detected when the value should be numeric)
data not valid	Supplied value is not acceptable for entered command
can't, wrong settings	Command not allowed for current measurement mode
can't, mode is service	Command not allowed while instrument is in service mode

The “save” and “set save params” commands (duplicated for backward compatibility) store parameters in FLASH memory. It is important that this command be sent each time instrument parameters are changed. If changes are not saved, they will be lost in the event of a power failure.

Convert Concentration Formats

Convert concentration formats from xxxxE+yy to x.xxxE+yy. The *i*Series uses more standard script than the C-Series by placing only one digit to the left of the decimal.

Commands List

Table B–1 lists the 42*i* C-Link protocol commands. The interface will respond to the command strings outlined below.

Table B–1. C-Link Protocol Commands

Command	Description	Page
1	Simulates pressing soft key 1 pushbutton	B-33
2	Simulates pressing soft key 2 pushbutton	B-33
3	Simulates pressing soft key 3 pushbutton	B-33
4	Simulates pressing soft key 4 pushbutton	B-33
addr dns	Reports/sets domain name server address for Ethernet port	B-43
addr gw	Reports/sets default gateway address for Ethernet port	B-43
addr ip	Reports/sets IP address for Ethernet port	B-43
addr nm	Reports/sets netmask address for Ethernet port	B-44
addr ntp	Reports the IP address for network time protocol server	B-44
alarm chamber temp max	Reports/sets chamber temperature alarm maximum value	B-14

C-Link Protocol Commands

Commands

Command	Description	Page
alarm chamber temp min	Reports/sets chamber temperature alarm minimum value	B-14
alarm conc no max	Reports/sets current NO concentration alarm maximum value	B-15
alarm conc no min	Reports/sets current NO concentration alarm minimum value	B-15
alarm conc no2 max	Reports/sets current NO ₂ concentration alarm maximum value	B-15
alarm conc no2 min	Reports/sets current NO ₂ concentration alarm minimum value	B-15
alarm conc nox max	Reports/sets current NO _x concentration alarm maximum value	B-15
alarm conc nox min	Reports/sets current NO _x concentration alarm minimum value	B-15
alarm converter temp max	Reports/sets NO ₂ converter temperature alarm maximum value	B-15
alarm converter temp min	Reports/sets NO ₂ converter temperature alarm minimum value	B-15
alarm cooler temp max	Reports/sets PMT cooler temperature alarm maximum value	B-16
alarm cooler temp min	Reports/sets PMT cooler temperature alarm minimum value	B-16
alarm internal temp max	Reports/sets internal temperature alarm maximum value	B-16
alarm internal temp min	Reports/sets internal temperature alarm minimum value	B-16
alarm pressure max	Reports/sets pressure alarm maximum value	B-16
alarm pressure min	Reports/sets pressure alarm minimum value	B-16
alarm sample flow max	Reports/sets sample flow alarm maximum value	B-17
alarm sample flow min	Reports/sets sample flow alarm minimum value	B-17
alarm trig conc no	Reports/sets current NO concentration alarm trigger sense	B-17
alarm trig conc no2	Reports/sets current NO ₂ concentration alarm trigger sense	B-17
alarm trig conc nox	Reports/sets current NO _x concentration alarm trigger sense	B-17
allow mode cmd	Reports/sets the current set allow mode command	B-47
analog iout range	Reports/sets analog current output range per channel	B-49
analog vin	Retrieves analog voltage input data per channel	B-50
analog vout range	Reports/sets analog voltage output range per channel	B-50
avg time	Reports/sets averaging time	B-10
baud	Reports/sets current baud rate	B-44

Command	Description	Page
bkg no	Reports/sets current NO background	B-29
bkg nox	Reports/sets current NO _x background	B-29
cal high no coef	Sets/auto-calibrates high range NO coefficient	B-27
cal high no2 coef	Sets/auto-calibrates high range NO ₂ coefficient	B-27
cal high nox coef	Sets/auto-calibrates high range NO _x coefficient	B-27
cal low no coef	Sets/auto-calibrates low range NO coefficient	B-27
cal low no2 coef	Sets/auto-calibrates low range NO ₂ coefficient	B-27
cal low nox coef	Sets/auto-calibrates low range NO _x coefficient	B-27
cal no bkg	Sets/auto-calibrates NO background	B-27
cal no coef	Sets/auto-calibrates NO coefficient	B-27
cal no2 coef	Sets/auto-calibrates NO ₂ coefficient	B-27
cal nox bkg	Sets/auto-calibrates NO _x background	B-27
cal nox coef	Sets/auto-calibrates NO _x coefficient	B-27
cal perm gas offset res	Sets/calibrates permeation gas temperature sensor offset using a calibrating resistor in ohms	B-29
cal perm gas offset temp	Sets/calibrates permeation gas temperature sensor offset to a temperature of degrees C	B-29
cal perm oven offset res	Sets/calibrates permeation oven temperature sensor offset using a calibrating resistor in ohms	B-30
clr lrecs	Clears away only long records that have been saved	B-19
clr records	Clears away all logging records that have been saved	B-19
clr srecs	Clears away only short records that have been saved	B-19
contrast	Reports/sets current screen contrast	B-39
conv set temp	Reports/sets temperature setpoint for NO ₂ converter	B-40
conv temp	Reports current NO ₂ converter temperature	B-12
cooler temp	Reports temperature of PMT cooler (same as PMT temperature)	B-12
copy lrec to sp	Sets/copies current lrec selection into the scratch pad	B-25
copy sp to lrec	Sets/copies current selections in scratch pad into lrec list	B-25
copy sp to srec	Sets/copies current selections in scratch pad into srec list	B-25
copy sp to stream	Sets/copies current selections in scratch pad into stream list	B-25
copy srec to sp	Sets/copies current srec selection into the scratch pad	B-25
copy stream to sp	Sets/copies current streaming data selection into the scratch pad	B-25
custom	Reports/sets defined custom range concentration	B-36

C-Link Protocol Commands
Commands

Command	Description	Page
data treatment lrec	Reports/sets data treatment for concentrations values in long records	B-19
data treatment srec	Reports/sets data treatment for concentrations values in short records	B-19
date	Reports/sets current date	B-40
default params	Sets parameters to default values	B-41
dhcp	Reports/sets state of use of DHCP	B-45
diag volt iob	Reports diagnostic voltage level for I/O expansion board	B-18
diag volt mb	Reports diagnostic voltage level for motherboard	B-18
diag volt mib	Reports diagnostic voltage level for measurement interface board	B-18
dig in	Reports status of the digital inputs	B-51
din	Reports/sets digital input channel and active state	B-51
do (down)	Simulates pressing down pushbutton	B-33
dout	Reports/sets digital output channel and active state	B-51
dtoa	Reports outputs of the digital to analog converters per channel	B-52
en (enter)	Simulates pressing enter pushbutton	B-33
er	Returns a brief description of the main operating conditions in the format specified in the commands	B-20
erec	Returns a snapshot of the main operating conditions (measurements and status) in the specified format	B-21
erec format	Reports/sets erec format (ASCII or binary)	B-22
erec layout	Reports current layout of erec data	B-23
flags	Reports 8 hexadecimal digits (or flags) that represent the status of the ozonator, PMT, gas mode, and alarms	B-13
flow	Reports current measured sample flow in LPM	B-12
format	Reports/sets current reply termination format	B-45
gas mode	Reports current mode of sample, zero, or span	B-37
gas unit	Reports/sets current gas units	B-38
he (help)	Simulates pressing help pushbutton	B-33
high avg time	Reports/sets high range averaging time	B-10
high no	Reports NO concentration calculated with high range coefficients	B-11
high no coef	Reports/sets high range NO coefficients	B-27
high no gas	Reports/sets high range NO span gas concentration	B-28

Command	Description	Page
high no2	Reports NO ₂ concentration calculated with high range coefficients	B-11
high no2 coef	Reports/sets high range NO ₂ coefficients	B-27
high no2 gas	Reports/sets high range NO ₂ span gas concentration	B-28
high nox	Reports NO _x concentration calculated with high range coefficients	B-11
high nox coef	Reports/sets high range NO _x coefficients	B-27
high nox gas	Reports/sets high range NO _x span gas concentration	B-28
high range no	Reports/selects current NO high range	B-35
high range no2	Reports/selects current NO ₂ high range	B-35
high range nox	Reports/selects current NO _x high range	B-35
host name	Reports/sets host name string	B-46
instr name	Reports instrument name	B-46
instrument id	Reports/sets instrument id	B-46
internal temp	Reports current internal instrument temperature	B-12
isc (iscreen)	Retrieves framebuffer data used for the display	B-33
layout ack	Disables stale layout/layout changed indicator ("*")	B-48
le (left)	Simulates pressing left pushbutton	B-33
list din	Lists current selection for digital input	B-19
list dout	Lists current selection for digital output	B-19
list lrec	Lists current selection lrec logging data	B-20
list sp	Lists current selection in the scratchpad list	B-20
list srec	Lists current selection srec logging data	B-20
list stream	Lists current selection streaming data output	B-20
list var aout	Reports list of analog output, index numbers, and variables	B-53
list var din	Reports list of digital input, index numbers, and variables	B-53
list var dout	Reports list of digital output, index numbers, and variables	B-53
low avg time	Reports/sets low averaging time	B-10
low no	Reports NO concentration calculated with low range coefficients	B-11
low no coef	Reports/sets low range NO coefficient	B-27
low no gas	Reports/sets low range NO span gas concentration	B-28
low no2	Reports NO ₂ concentration calculated with low range coefficients	B-11
low no2 coef	Reports/sets low range NO ₂ coefficient	B-27

Command	Description	Page
low no2 gas	Reports/sets low range NO ₂ span gas concentration	B-28
low nox	Reports NO _x concentration calculated with low range coefficients	B-11
low nox coef	Reports/sets low range NO _x coefficient	B-27
low nox gas	Reports/sets low range NO _x span gas concentration	B-28
low range no	Reports/sets current NO low range	B-35
low range no2	Reports/sets current NO ₂ low range	B-35
low range nox	Reports/sets current NO _x low range	B-35
lr	Outputs long records in the format specified in the command	B-20
lrec	Outputs long records	B-21
lrec format	Reports/sets output format for long records (ASCII or binary)	B-22
lrec layout	Reports current layout of lrec data	B-23
lrec mem size	Reports maximum number of long records that can be stored	B-23
lrec per	Reports/sets long record logging period	B-24
malloc lrec	Reports/sets memory allocation for long records	B-24
malloc srec	Reports/sets memory allocation for short records	B-24
mb read coils	Reports the current state of the MODBUS coils (digital outputs)	B-53
mb read registers	Reports the current state of the MODBUS registers (analog outputs)	B-53
mb write coil	Sets the current state of MODBUS coil (digital input)	B-54
me (menu)	Simulates pressing menu pushbutton	B-33
meas mode	Reports/sets which measurement mode is active	B-38
menutext	Displays the text of the menu item where the cursor is currently positioned	B-34
mode	Reports operating mode in local, service, or remote	B-47
no	Reports current NO concentration	B-11
no bkg	Reports/sets current NO background	B-29
no coef	Reports/sets current NO coefficient	B-27
no gas	Reports/sets NO span gas concentration	B-28
no of lrec	Reports/sets number of long records stored in memory	B-24
no of srec	Reports/sets number of short records stored in memory	B-24
no2	Reports current NO ₂ concentration	B-11
no2 coef	Reports/sets current NO ₂ coefficient	B-27
no2 gas	Reports/sets NO ₂ span gas concentration	B-28

Command	Description	Page
nox	Reports current NO _x concentration	B-11
nox bkg	Reports/sets current NO _x background	B-29
nox coef	Reports/sets current NO _x coefficient	B-27
nox gas	Reports/sets NO _x span gas concentration	B-28
ozonator	Reports/sets ozonator on or off	B-41
ozonator flow	Reports current ozonator flow	B-41
ozonator safety	Reports/sets ozonator safety on or off	B-41
ozonator status	Reports status of ozonator and safety	B-41
perm gas temp	Reports current permeation gas temperature	B-12
pmt status	Reports/sets PMT status on or off	B-42
pmt temp	Reports temperature of the PMT cooler (same as cooler temperature)	B-13
pmt voltage	Reports current PMT voltage	B-13
power up mode	Reports/sets the power up mode as local or remote	B-48
pres	Reports current reaction chamber pressure	B-13
pres comp	Reports/sets pressure compensation on or off	B-38
program no	Reports analyzer program number	B-48
push	Simulates pressing a key on the front panel	B-33
range mode	Reports/sets current range mode	B-37
range no	Reports/sets current NO range	B-35
range no2	Reports/sets current NO ₂ range	B-35
range nox	Reports/sets current NO _x range	B-35
react temp	Reports current reaction chamber temperature	B-13
relay stat	Reports/sets relay logic status to for the designated relay(s)	B-54
ri (right)	Simulates pressing right pushbutton	B-33
ru (run)	Simulates pressing run pushbutton	B-33
sample	Sets zero/span valves to sample mode	B-37
sample flow	Reports current measured sample flow in LPM	B-12
sample gas	Sets zero/span valves to sample gas mode	B-37
save	Stores parameters in FLASH	B-42
save params	Stores parameters in FLASH	B-42
sc (screen)	C-series legacy command that reports a generic response (Use iscreen instead)	B-34
sp field	Reports/sets item number and name in scratch pad list	B-25

Command	Description	Page
span	Sets zero/span valves to span mode	B-37
span cal reset	Reports/sets span cal reset on/off	B-30
span dev	Reports/sets span deviation (maximum span check offset)	B-30
span dur	Reports/sets how long span gas is sampled by the instrument	B-30
span gas	Sets zero/span valves to span gas mode	B-37
sr	Reports last short record stored	B-20
srec	Reports maximum number of short records	B-21
srec format	Reports/sets output format for short records (ASCII or binary)	B-22
srec layout	Reports current layout of short record data	B-23
srec mem size	Reports maximum number of short records	B-23
srec per	Reports/sets short record logging period	B-24
stream per	Reports/sets current set time interval for streaming data	B-26
stream time	Reports/sets a time stamp to streaming data or not	B-26
temp comp	Reports/sets temperature compensation on or off	B-39
time	Reports/sets current time (24-hour time)	B-42
tz	Reports/sets the timezone string for the network time protocol server	B-49
up	Simulates pressing up pushbutton	B-33
version	Reports version of all the firmware components	B-18
zero	Sets zero/span valves to zero mode	B-37
zero cal reset	Reports/sets zero cal reset on/off	B-30
zero dev	Reports/sets zero deviation (maximum zero check offset)	B-30
zero dur	Reports/sets how long zero gas is sampled by the instrument	B-30
zero gas	Sets zero/span valves to zero gas mode	B-37
zs avg time	Reports/sets zero/span averaging time	B-31
zs period	Reports/sets zero/span period	B-31

Measurements

avg time
high avg time
low avg time

These commands report the averaging time in seconds when operating in single range, or averaging time used with the high and low ranges when operating in dual or auto range mode. The example below shows that the averaging time is 300 seconds, according to [Table B-2](#).

Send: avg time
Receive: avg time 11:300 sec

set avg time selection
set high avg time selection
set low avg time selection

These commands set the averaging time, high and low averaging times, according to [Table B-2](#). The example below sets the low range averaging time to 120 seconds.

Send: set low avg time 8
Receive: set low avg time 8 ok

Table B-2. Averaging Times

<i>Selection</i>	Time, NO Measure Mode, NO_x Measure Mode	Time, NO/NO_x Measure Mode
0	1 seconds	
1	2	
2	5	
3	10	10 seconds
4	20	20
5	30	30
6	60	60
7	90	90
8	120	120
9	180	180
10	240	240
11	300	300

no
no2
nox
high no
high no2
high nox
low no
low no2
low nox

These commands report the measured NO, NO₂, and NO_x concentrations when operating in single range, or high and low NO, NO₂, and NO_x when

operating in dual or auto range mode. The example below shows that the NO concentration is 67.2 ppb.

```
Send:      no
Receive:   no 6.720E+01 ppb
```

conv temp

This command reports the current NO₂ converter temperature. The example below reports that the current converter temperature is 320.7 °C.

```
Send:      conv temp
Receive:   conv temp 320.7 deg C
```

cooler temp

This command reports the current PMT cooler temperature. The example below reports that the current PMT cooler temperature is -2.8 °C.

```
Send:      pmt temp
Receive:   pmt temp -2.8 deg C
```

flow

sample flow

These commands report the current measured flow. The example below reports that the flow measurement is 0.700 liters/minute.

```
Send:      flow
Receive:   flow 0.7 1/m
```

internal temp

This command reports the current internal instrument temperature. The first reading is the temperature being used in instrument calculations. The second temperature is the actual temperature being measured. If temperature compensation is on, then both temperature readings are the same. If temperature compensation is off, a temperature of 30 °C is used as the default temperature even though the actual internal temperature is 27.2 °C. The example below shows that temperature compensation is on and that the internal temperature is 27.2 °C.

```
Send:      internal temp
Receive:   internal temp 027.2 deg C, actual 027.2
```

perm gas temp

This command reports the current permeation gas temperature. The example below reports that the permeation gas temperature is 45 °C.

```
Send:      perm gas temp
Receive:   perm gas temp 45 deg C
```

pmt temp

This command reports the PMT cooler temperature. The example below reports that the PMT cooler temperature is -2.8 °C.

```
Send:      pmt temp
Receive:   pmt temp -2.8 deg C
```

pmt voltage

This command reports the PMT voltage. The example below reports that the current PMT voltage is -750 volts.

```
Send:      pmt voltage
Receive:   pmt voltage -750
```

pres

This command reports the current reaction chamber pressure. The first pressure reading is the pressure reading being used in instrument calculations. The second pressure is the actual pressure reading being measured. If pressure compensation is on, then both pressure readings are the same. If pressure compensation is off, a pressure of 300 mmHg is used as default pressure even though the actual pressure is 306.3 mmHg. The example below shows that the actual reaction chamber pressure is 306.3 mmHg.

```
Send:      pres
Receive:   pres 753.4 mm Hg, actual 306.6
```

react temp

This command reports the current reaction chamber temperature. The example below reports that the current reaction temperature is 49.0 °C.

```
Send:      react temp
Receive:   react temp 49.0 deg C
```

flags

This reports 8 hexadecimal digits (or flags) that represent the status of the ozonator, PMT, pressure and temperature compensation status, gas units, gas mode, and alarms. To decode the flags, each hexadecimal digit is converted to binary as shown in the [Figure B-1](#). It is the binary digits that define the status of each parameter. In the example below, the instrument is reporting that the ozonator and PMT are both on, and that the instrument is in the span gas mode.

```
Send:      flags
Receive:   flags 80028000
```

C-Link Protocol Commands

Alarms

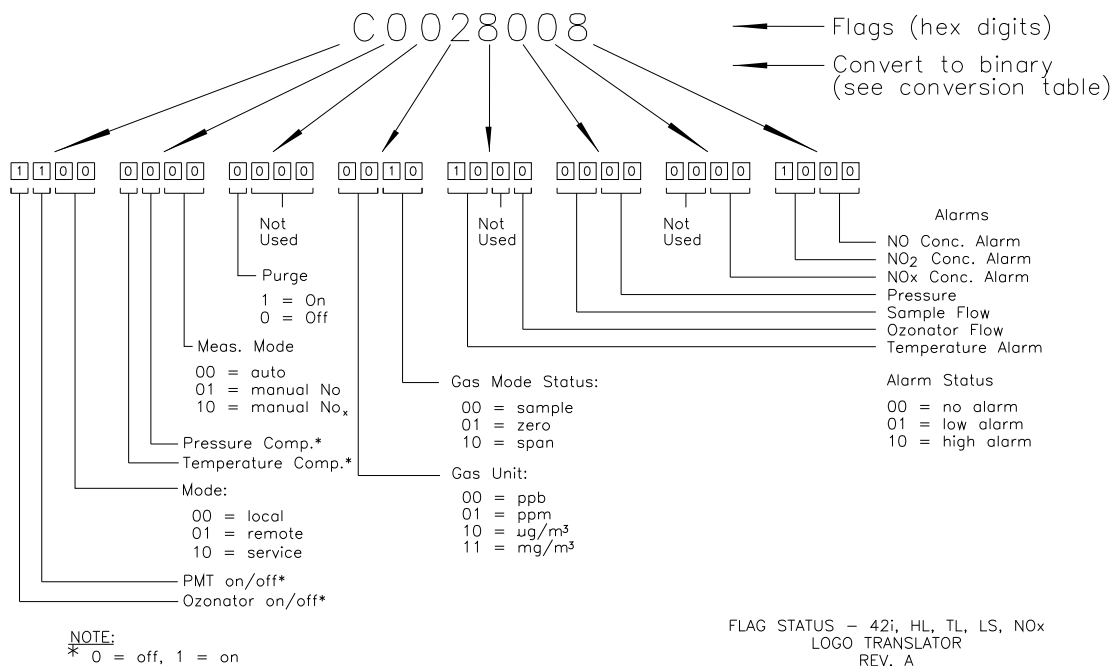

Hex to Binary Conversion Table	
0 = 0000	8 = 1000
1 = 0001	9 = 1001
2 = 0010	A = 1010
3 = 0011	B = 1011
4 = 0100	C = 1100
5 = 0101	D = 1101
6 = 0110	E = 1110
7 = 0111	F = 1111

Figure B-1. Flags

Alarms

alarm chamber temp min

alarm chamber temp max

These commands report the chamber temperature alarm minimum and maximum value current settings. The example below reports that the chamber temperature alarm minimum value is 47.0 °C.

```
Send:          alarm chamber temp min
Receive:       alarm chamber temp min 47.0 deg C
```

set alarm chamber temp min *value*

set alarm chamber temp max *value*

These commands set the chamber temperature alarm minimum and maximum values to *value*, where *value* is a floating-point number representing chamber temperature alarm limits in degrees C. The example below sets the chamber temperature alarm maximum value to 50.0 °C.

```
Send:          set alarm chamber temp max 50.0
Receive:       set alarm chamber temp max 50.0 ok
```

alarm conc no min
alarm conc no2 min
alarm conc nox min
alarm conc no max
alarm conc no2 max
alarm conc nox max

These commands report the NO, NO₂, and NO_x concentration alarm minimum and maximum values current setting. The example below reports that the NO concentration minimum is 5.2 ppb.

Send: alarm conc no min
Receive: alarm conc no min 5.2 ppb

set alarm conc no min *value*
set alarm conc no2 min *value*
set alarm conc nox min *value*
set alarm conc no max *value*
set alarm conc no2 max *value*
set alarm conc nox max *value*

These commands set the NO, NO₂, and NO_x concentration alarm minimum and maximum values to *value*, where *value* is a floating-point representation of the concentration alarm limits. Values must be in the units that are currently set for use. The example below sets the NO concentration alarm maximum value to 215.

Send: set alarm conc no max 215
Receive: set alarm conc no max 215 ok

alarm converter temp min
alarm converter temp max

These commands report the converter temperature alarm minimum and maximum value current settings. The example below reports that the converter temperature alarm minimum value is 300.0 °C.

Send: alarm converter temp min
Receive: alarm converter temp min 300.0 deg C

set alarm converter temp min *value*
set alarm converter temp max *value*

These commands set the converter temperature alarm minimum and maximum values to *value*, where *value* is a floating-point number representing converter temperature alarm limits in degrees C. The example below sets the converter temperature alarm maximum value to 340.0 °C.

Send: set alarm converter temp max 340
Receive: set alarm converter temp max 340 ok

alarm cooler temp min

alarm cooler temp max

These commands report the cooler temperature alarm minimum and maximum value current settings. The example below reports that the cooler temperature alarm minimum value is -10.0 °C.

Send: alarm cooler temp min
Receive: alarm cooler temp min -10.0 deg C

set alarm cooler temp min *value*

set alarm cooler temp max *value*

These commands set the cooler temperature alarm minimum and maximum values to *value*, where *value* is a floating-point number representing cooler temperature alarm limits in degrees C. The example below sets the cooler temperature alarm maximum value to -2.0 °C.

Send: set alarm cooler temp max -2.0
Receive: set alarm cooler temp max -2.0 ok

alarm internal temp min

alarm internal temp max

These commands report the internal temperature alarm minimum and maximum value current settings. The example below reports that the internal temperature alarm minimum value is 15.0 °C.

Send: alarm internal temp min
Receive: alarm internal temp min 15.0 deg C

set alarm internal temp min *value*

set alarm internal temp max *value*

These commands set the internal temperature alarm minimum and maximum values to *value*, where *value* is a floating-point number representing internal temperature alarm limits in degrees C. The example below sets the internal temperature alarm maximum value to 35.0 °C.

Send: set alarm internal temp max 35
Receive: set alarm internal temp max 35 ok

alarm pressure min

alarm pressure max

These commands report the pressure alarm minimum and maximum value current settings. The example below reports that the pressure alarm minimum value is 150 mmHg.

Send: alarm pressure min
Receive: alarm pressure min 150 mmHg

set alarm pressure min *value*

set alarm pressure max *value*

These commands set the pressure alarm minimum and maximum values to *value*, where *value* is a floating-point number representing pressure alarm limits in millimeters of mercury. The example below sets the pressure alarm maximum value to 290 mmHg.

```
Send:          set alarm pressure max 290
Receive:       set alarm pressure max 290 ok
```

alarm sample flow min

alarm sample flow max

These commands report the sample flow alarm minimum and maximum value current settings. The example below reports that the sample flow alarm minimum value is 0.300 LPM.

```
Send:          alarm sample flow min
Receive:       alarm sample flow min 0.3 l/min
```

set alarm sample flow min *value*

set alarm sample flow max *value*

These commands set the sample flow alarm minimum and maximum values to *value*, where *value* is a floating-point number representing sample flow alarm limits in liters per minute. The example below sets the sample flow alarm maximum value to 1 LPM.

```
Send:          set alarm sample flow max 1
Receive:       set alarm sample flow max 1 ok
```

alarm trig conc no

alarm trig conc no2

alarm trig conc nox

This command reports the NO, NO₂, and NO_x concentration alarm trigger action for minimum alarm, current setting, to either floor or ceiling. The example below shows the NO concentration minimum alarm trigger to ceiling, according to [Table B-3](#).

```
Send:          alarm trig conc no
Receive:       alarm trig conc no 1
```

set alarm trig conc no *value*

set alarm trig conc no2 *value*

set alarm trig conc nox *value*

These commands set the NO, NO₂, and NO_x concentration alarm minimum *value*, where *value* is set to either floor or ceiling, according to [Table B-3](#). The example below sets the NO concentration minimum alarm trigger to ceiling.

```
Send:      set alarm trig conc no 1
Receive:   set alarm trig conc no 1 ok
```

Table B–3. Alarm Trigger Values

<i>Value</i>	Alarm Trigger
00	Floor
01	Ceiling

Diagnostics

diag volt mb

This command reports the diagnostic voltage measurements on the motherboard. The sequence of voltages is: Positive 24, positive 15, positive 5, positive 3.3, and negative 3.3. Each voltage value is separated by a space.

```
Send:      diag volt mb
Receive:   diag volt mb 24.1 14.9 4.9 3.2 -3.2
```

diag volt mib

This command reports the diagnostic voltage measurements on the measurement interface board. The sequence of voltages is: Positive 24, positive 15, negative 15, positive 5, positive 3.3, and positive 15. Each voltage value is separated by a space.

```
Send:      diag volt mib
Receive:   diag volt mib 24.1 14.9 -14.9 4.9 3.2 14.9
```

diag volt iob

This command reports the diagnostic voltage measurements on the I/O expansion board. The sequence of voltages is: Positive 24, positive 5, positive 3.3, and negative 3.3. Each voltage value is separated by a space.

```
Send:      diag volt iob
Receive:   diag volt iob 24.1 4.9 3.2 -3.2
```

version

This command reports the version of all the firmware components. The following example shows a list of the firmware components that were displayed by issuing the version command.

```
Send:      version
Receive:   version
           Program = 01.05.79.225
           Library = 01.01.60.167
           Kernal = 2.4.24-uc0-003-Thermo
           Board = 81, File = /usr/application.hex
           Board App = 11.3.100 BI 4.0.97
           File App = 11.3.100 BI 4.0.97
```

```
Board = 84, File = /usr/application.hex
Board App = 11.3.100 BI 4.0.97
File App = 11.3.100 BI 4.0.97
Arc BI = 170711*
```

Datalogging

clr records

This command will clear all long and short records that have been saved.

```
Send:      clr records
Receive:   clr records ok
```

set clr lrecs

set clr srecs

These commands will clear only the long records or only the short records that have been saved. The example below clears short records.

```
Send:      set clr srecs
Receive:   set clr srecs ok
```

data treatment lrec

data treatment srec

These commands report the current selection of data treatment for concentrations in the long records (lrecs) or short records (srecs). The example below reports the data treatment for concentrations in lrec is minimum.

```
Send:      data treatment lrec
Receive:   data treatment lrec min
```

set data treatment lrec *string*

set data treatment srec *string*

string = | cur | avg | min | max |

These commands set the data treatment to current, average, minimum, or maximum for the concentration values recorded in the long records (lrecs) or short records (srecs). The example below sets the data treatment for concentrations in lrec to minimum.

```
Send:      set data treatment lrec min
Receive:   set data treatment lrec min ok
```

list din

list dout

These commands report the current selection for the digital outputs in the format. Output no Index number variable name active state. The active state for digital outputs is open or closed. The active state for digital inputs is high or low.

```
Send:      list dout
Receive:   list dout
           output index variable state
           1 35 CONC ALARM open
           3 4 UNITS open
           4 11 GEN ALARM closed
           7 7 NO MODE open
           8 8 NOX MODE open
```

list lrec

list srec

list stream

list sp

These commands report the list of current selections for lrec logging data, srec logging data, streaming data output, or the scratch pad (sp) list.

The scratch pad is a temporary memory area which is used to set up lists of selections for lrec, srec, or streaming data items. The user can copy any of these lists to the scratch pad, modify individual elements in the list, then save the scratch pad back to the original list. Refer to the “sp field” command for information on how to edit the scratch pad.

The following example shows the list for streaming data output.

```
Send:      list stream
Receive:   list stream
           field index variable
           x x time
           1 1 no
           2 2 no2
           3 3 nox
           4 18 intt
           5 25 pres
           6 26 smp1f
```

er xy

lr xy

sr xy

$x = | 0 | 1 |$: Reply termination format (see “set format *format*” command)

$y = | 0 | 1 | 2 |$: Output format (see “set errec/lrec/srec format *format*” command)

These commands report the last long and short records stored or the dynamic data record. In the example below, the command requests a long record with no checksum, in ASCII format with text. For details on how to decode the flag fields within these records, see the “flags” command.

```
Send:      lr01
Receive:   lr01
```

```
12:31 02-22-03 flags 54089100 no -8413E-1 nox -8485E-1
lono -6471E-1 lonox -6527E-1 pres 130.9 pmtt 53.2 intt
80.0 rctt 80.0 convt 61 smp1f 0.500 ozonf 0.000 pmtv -
115
```

erec

This command returns a snapshot of the main operating conditions (measurements and status) at the time the command is issued. The following example shows a typical response.

The format is defined by the current settings of the “format” and “erec format” commands. For details on erec formatting, see the “Record Layout Definition” section at the end of this appendix. For details on how to decode the flag fields within these records, see the “flags” command.

```
Send:      erec
Receive:   erec
10:11 04-06-05 flags DD008000 no 0.000 nox 0.000 no2
0.000 1 lono 147.500 lonox 0.000 lono2 0.000 1 pmtv
805.491 tempal 1 pres 172.278 pcal 150.000 smp1f 0.000
ozonf 0.050 hiavgtime 10 loavgtime 10 nobkg 0.000
noxbkg 0.000 noccoef 1.000 noxcoef 1.000 no2coef 1.000
lonoccoef 1.000 lonoxcoef 1.000 lono2coef 1.000 norange
100000.000 noxrange 100000.000 no2range 100000.000
lonorange 100000.000 lonoxrange 100000.000 lono2range
100000.000
```

lrec

srec

lrec *xxxx yy*

srec *xxxx yy*

lrec *aa:bb oo-pp-qq yy*

srec *aa:bb oo-pp-qq yy*

xxxx = the number of past records

yy = the number of records to return (1 to 10)

aa = hours (01 to 24)

bb = minutes (01 to 59)

oo = month (01 to 12)

pp = day (01 to 31)

qq = year

These commands output long or short records and dynamic data. The output format is determined by the “set lrec format”, and “set srec format” commands. The logging time is determined by the “set lrec per” and “set srec per” commands. In dual range, the long records and short records contain the high and low NO and NO_x concentrations. In single range the low NO and low NO_x values are set to 0 and the high NO and high NO_x are used. In NO or NO_x only mode, the pertinent high value used, other

concentrations are set to 0. Concentrations are stored in either ppb or $\mu\text{g}/\text{m}^3$.

In the following example, there are 740 long records currently stored in memory. When the command `lrec 100 5` is sent, the instrument counts back 100 records from the last record collected (record 740), and then returns 5 records: 640, 641, 642, 643, and 644. For details on how to decode the flag fields within these records, see the “flags” command.

```
Send:          lrec 5
Receive:       lrec 100 5
              11:03 02-22-03  flags 54089100 no 8416E-1 nox 8458E-1
              lono 6474E-1 lonox 6506E-1 pres 131.4 pmtt 53.1 intt
              80.0 rctt 80.0 convt 61 smp1f 0.500 ozonf 0.000 pmtv -
              116
              11:04 02-22-03  flags 54089100 no 8421E-1 nox 8457E-1
              lono 6477E-1 lonox 6505E-1 pres 131.5 pmtt 53.1 intt
              80.0 rctt 80.0 convt 61 smp1f 0.500 ozonf 0.000 pmtv -
              116
              11:05 02-22-03  flags 54089100 no 8440E-1 nox 8456E-1
              lono 6492E-1 lonox 6505E-1 pres 131.5 pmtt 53.2 intt
              80.0 rctt 80.0 convt 61 smp1f 0.500 ozonf 0.000 pmtv -
              116
              11:06 02-22-03  flags 54089100 no 8432E-1 nox 8483E-1
              lono 6486E-1 lonox 6525E-1 pres 133.0 pmtt 53.0 intt
              80.0 rctt 80.0 convt 61 smp1f 0.500 ozonf 0.000 pmtv -
              116
              11:07 02-22-03  flags 54089100 no 8442E-1 nox 8383E-1
              lono 6494E-1 lonox 6449E-1 pres 131.5 pmtt 53.1 intt
              80.0 rctt 80.0 convt 61 smp1f 0.500 ozonf 0.000 pmtv -
              116
```

where:

pmtv = PMT Voltage
pmtt = PMT Temperature
intt = Internal Temperature
rctt = Reaction Chamber Temperature
convt = NO₂ Converter Temperature
smp1f = Sample Flow
ozonf = Ozonator Flow
pres = Pressure

erec format

lrec format

srec format

These commands report the output format for long and short records, and dynamic data in various formats such as ASCII without text, ASCII with text, or binary. The example below shows the output format for long records is ASCII with text, according to [Table B-4](#).

```
Send:      lrec format
Receive:   lrec format 1
```

set erec format *format*

set lrec format *format*

set srec format *format*

These commands set the output format for long and short records, and dynamic data, according to [Table B-4](#). The example below sets the long record output format to ASCII with text.

```
Send:      set lrec format 1
Receive:   set lrec format 1 ok
```

Table B-4. Record Output Formats

<i>Format</i>	Output Format
0	ASCII no text
1	ASCII with text
2	Binary data

erec layout

lrec layout

srec layout

These commands report the layout (string indicating the data formats) for data that is sent out in response to the erec, lrec, srec, and related commands. For details on how to interpret the strings, see “Record Layout Definition” later in this appendix.

```
Send:      lrec layout
Receive:   lrec layout %s %s %lx %f %f %f %f %f %f %f %f %f %f %f %f
           %f
           t D L ffffffff
           flags no nox hino hinox pres pmtt intt rctt convt simplf
           ozonf pmtv
```

lrec mem size

srec mem size

These commands report the number of lrecs and srecs that can be stored with the current settings and the number of blocks reserved for lrecs and srecs. The example that follows shows that 1075 blocks were reserved for lrecs and the maximum number of lrecs that can be stored in memory is 241979. Memory allocation can be changed using the malloc command.

```
Send:      lrec mem size
Receive:   lrec mem size 241979 recs, 1075 blocks
```

lrec per

srec per

These commands report the long and short records logging period. The example below shows that the short record logging period is 5 minutes.

```
Send:          srec per
Receive:       srec per 5 min
```

set lrec per *value*

set srec per *value*

value = | 1 | 5 | 15 | 30 | 60 |

These commands set the long and short records logging period to *value* in minutes. The example below sets the long record logging period to 15 minutes.

```
Send:          set lrec per 15
Receive:       set lrec per 15 ok
```

no of lrec

no of srec

These commands report the number of long and short records stored in the long and short records memory. The example below shows that 50 long records have been stored in the memory.

```
Send:          no of lrec
Receive:       no of lrec 50 recs
```

malloc lrec

malloc srec

These commands report the currently set memory allocation for long and short records in percent of total memory.

```
Send:          malloc lrec
Receive:       malloc lrec 10%
```

set malloc lrec *value*

set malloc srec *value*

value = 0 to 100

These commands set the percent of memory space allocated for long and short records to *value*, where *value* is a floating-point number representing percent. The example below sets the memory allocation for long records to 10.

Note Issuing these commands will clear all the logging data memory. All the existing records should be retrieved using appropriate commands, if required. ▲

```
Send:      set malloc lrec 10
Receive:   set malloc lrec 10 ok
```

set copy sp to lrec

set copy sp to srec

set copy sp to stream

These commands copy the current selections in scratch pad (sp) into the lrec, srec, or streaming data list.

The scratch pad is a temporary memory area which is used to set up lists of selections for lrec, srec, or streaming data items. The user can copy any of these lists to the scratch pad, modify individual elements in the list, then save the scratch pad back to the original list. For more information on how to edit the scratch pad, see the “sp field” command.

The following example copies the current list in scratch pad into the lrecs list.

```
Send:      set copy sp to lrec
Receive:   set copy sp to lrec ok
```

set copy lrec to sp

set copy srec to sp

set copy stream to sp

These commands copy the current selections in scratch pad (sp) into the lrec, srec, or streaming data list.

The scratch pad is a temporary memory area which is used to set up lists of selections for lrec, srec, or streaming data items. The user can copy any of these lists to the scratch pad, modify individual elements in the list, then save the scratch pad back to the original list. For more information on how to edit the scratch pad, see the “sp field” command.

The following example copies the current list in scratch pad into the lrecs list.

```
Send:      set copy lrec to sp
Receive:   set copy lrec to sp ok
```

sp field *number*

This command reports the variable *number* and name stored at the index in the scratch pad list.

The scratch pad is a temporary memory area which is used to set up lists of selections for lrec, srec, or streaming data items. The user can copy any of these lists to the scratch pad, modify individual elements in the list, then save the scratch pad back to the original list.

The following example shows that field 5 in the scratch pad is set to index number 13, which is for the variable pressure.

Send: sp field 5
Receive: sp field 5 13 pres

set sp field *number value*

number = 1-32 for lrec and srec lists, 1-8 for streaming data lists

This command sets the scratch pad field *number* (item number in scratch pad list) to *value*, where *value* is the index number of a variable in the analog out variable list. Available variables and their corresponding index numbers may be obtained using the command “list var aout”. The “set sp field” command is used to create a list of variables which can then be transferred into the long record, short record, or streaming data lists, using the “set copy sp to lrec”, “set copy sp to srec”, or “set copy sp to stream” commands.

Send: set sp field 1 34
Receive: set sp field 1 34 ok

stream per

This command reports the currently set time interval in seconds for streaming data.

Send: stream per
Receive: stream per 10

set stream per *number value*

number value = | 1 | 2 | 5 | 10 | 20 | 30 | 60 | 90 | 120 | 180 | 240 | 300 |

This command sets the time interval between two consecutive streaming data strings to *number value* in seconds. The example below sets the number value to 10 seconds.

Send: set stream per 10
Receive: set stream per 10 ok

stream time

This command reports if the streaming data string will have a time stamp attached to it or not, according to [Table B-5](#).

Send: stream time
Receive: stream time 0

set stream time *value*

This command enables *value*, where *value* is to attach or disable time stamp to streaming data string, according to [Table B-5](#). The example below attaches a time stamp to streaming data.

Send: set stream time 0
Receive: set stream time 0 ok

Table B-5. Stream Time Values

Value	Stream Time
00	Attaches time stamp to streaming data string
01	Disables time stamp to streaming data string

Calibration

set cal no bkg

set cal nox bkg

These commands will auto-calibrate the NO, and NO_x backgrounds. If the instrument is set to manual NO_x mode, the response to “set cal no bkg” will be “can’t, wrong settings”. The example below shows a successful auto-calibration of the NO background.

Send: set cal no bkg
Receive: set cal no bkg ok

set cal no coef

set cal no2 coef

set cal nox coef

set cal high no coef

set cal high no2 coef

set cal high nox coef

set cal low no coef

set cal low no2 coef

set cal low nox coef

These commands will auto-calibrate NO, NO₂, and NO_x coefficients based on NO, NO₂, and NO_x span gas concentrations. The high and low commands are only available in dual and auto range mode. If the mode is incorrect, the instrument responds with “can’t, wrong settings”. The example below shows a successful auto-calibration of the low NO coefficient.

Send: set cal low no coef
Receive: set cal low no coef ok

no coef

no2 coef

nox coef

high no coef

high no2 coef

high nox coef

low no coef

low no2 coef

low nox coef

These commands report NO, NO₂, and NO_x coefficients in single range mode, or the high and low range coefficients in dual or auto range mode. If the mode is incorrect, the instrument responds with “can’t, wrong settings”. The example below reports that the NO coefficient is 1.000.

Send: no coef
Receive: no coef 1.000

set no coef *value*
set no2 coef *value*
set nox coef *value*
set high no coef *value*
set high no2 coef *value*
set high nox coef *value*
set low no coef *value*
set low no2 coef *value*
set low nox coef *value*

These commands set the NO, NO₂, and NO_x coefficients to user-defined values to *value*, where *value* is a floating-point representation of the coefficient. The example below sets the NO coefficient to 1.005.

Send: set no coef 1.005
Receive: set no coef 1.005 ok

no gas
no2 gas
nox gas
high no gas
high no2 gas
high nox gas
low no gas
low no2 gas
low nox gas

These commands report NO, NO₂, and NO_x span gas concentrations used to auto-calibrate NO, NO₂, and NO_x coefficients. The high and low commands are only available in dual and auto range mode. If the mode is incorrect, the instrument responds with “can’t, wrong settings”. The example below reports that the NO low span gas concentration is 240.0 ppb.

Send: low no gas
Receive: low no gas 2400E-1 ppb

set no gas *value*
set no2 gas *value*
set nox gas *value*
set high no gas *value*

set high no2 gas *value*
set high nox gas *value*
set low no gas *value*
set low no2 gas *value*
set low nox coef *value*

These commands set the NO, NO₂, and NO_x span gas concentrations used by the auto-calibration routine to *value*, where *value* is a floating-point representation of the gas concentration in current selected units. The gas units are the same as those chosen by the user. The example below sets the NO span gas concentration to 123.4 ppb.

Send: set no gas 123.4
 Receive: set no gas 123.4 ok

no bkg
nox bkg
bkg no
bkg nox

These commands report the current NO and NO_x backgrounds. The example below reports that the NO background is 5.5 ppb.

Send: no bkg
 Receive: no bkg 5.5 ppb

set no bkg *value*
set nox bkg *value*
set bkg no *value*
set bkg nox *value*

These commands are used to set NO and NO_x backgrounds to user-defined values to *value*, where *value* is a floating-point representation of the background in current selected units. The example below sets the NO background to 5.5 ppb.

Send: set no bkg 5.5
 Receive: set no bkg 5.5 ok

set cal perm gas offset res *res*

This command calibrates the permeation gas temperature sensor offset using a calibrating resistor of value *res* in ohms.

Send: set cal perm gas offset res 5000
 Receive: set cal perm gas offset res 5000 ok

set cal perm gas offset temp *temp*

This command calibrates the permeation gas temperature sensor offset to a temperature of *temp* in degrees C.

```
Send:      set cal perm gas offset temp 34.5
Receive:   set cal perm gas offset temp 34.5 ok
```

set cal perm oven offset res *res*

This command calibrates the permeation oven temperature sensor offset using a calibrating resistor of value *res* in ohms.

```
Send:      set cal perm oven offset res 5000
Receive:   set cal perm oven offset res 5000 ok
```

span dev

This command reports the span deviation (span check offset). The following example reports that the span deviation is 1 ppb.

```
Send:      span dev
Receive:   span dev 1.000 E+00
```

set span dev *value*

This command sets the span deviation (span check offset) to *value*, where *value* is a floating-point representation of the gas concentration in current selected units. The following example sets the span deviation to 345 ppb.

```
Send:      set span dev 345
Receive:   set span dev 345 ok
```

zero dev

This command reports the zero deviation (maximum zero check offset). The following example reports that the zero deviation is 10 ppb.

```
Send:      zero dev
Receive:   zero dev 1.000 E+01
```

set zero dev *value*

This command sets the zero deviation (maximum zero check offset) to *value*, where *value* is a floating-point representation of the gas concentration in current selected units. The following example sets the zero deviation to 10 ppb.

```
Send:      set zero dev 1.000 E+01
Receive:   set zero dev 1.000 E+01 ok
```

span cal reset

This command reports that the span cal reset is on or off. The following example reports that the span cal reset is on.

```
Send:      span cal reset
Receive:   span cal reset on
```

set span cal reset *onoff*
onoff = | on | off |

This command sets the span cal reset to *on* or *off*. The following example sets the span cal reset to *off*.

Send: set span cal reset off
Receive: set span cal reset off ok

zero cal reset

This command reports that the zero cal reset is on or off. The following example reports that the zero cal reset is on.

Send: zero cal reset
Receive: zero cal reset on

set zero cal reset *onoff*
onoff = | on | off |

This command sets the zero cal reset to *on* or *off*. The following example sets the zero cal reset to *off*.

Send: set zero cal reset off
Receive: set zero cal reset off ok

span dur

This command reports the span duration. The following example reports that the span duration is 10 minutes.

Send: span dur
Receive: span dur 10 min

set span dur *value*

This command sets the span duration to *value*, where *value* represents the span duration in minutes. The following example sets the span duration to 15 minutes.

Send: set span duration 15
Receive: set span duration 15 ok

zero dur

This command reports the zero duration. The following example reports that the zero duration is 10 minutes.

Send: zero dur
Receive: zero dur 10 min

set zero dur *value*

This command sets the zero duration to *value*, where *value* represents the zero duration in minutes. The following example sets the zero duration to 15 minutes.

```
Send:          set zero duration 15
Receive:       set zero duration 15 ok
```

zs period

This command reports the zero/span (z/s) period. The following example reports that the zero/span period is 24 hours.

```
Send:          zs period
Receive:       zs period 24 hr
```

set zs period *value*

This command sets the zero/span period to *value*, where *value* represents the zero/span period in hours. The following example sets the zero/span period to 24 hours.

```
Send:          set zs period 24
Receive:       set zs period 24 hr ok
```

zs avg time

This command reports the zero/span (z/s) averaging time in seconds. The following example reports that the zero/span averaging time is 30 seconds, according to [Table B-2](#).

```
Send:          zs avg time
Receive:       zs avg time 5:30 sec
```

set zs avg time *selection*

This command sets the zero/span averaging time, according to [Table B-2](#). The following example sets the zero/span averaging time to 120 seconds.

```
Send:          set zs avg time 8
Receive:       set zs avg time 8 ok
```

Keys/Display

push *button*

do	ri
down	right
en	ru
enter	run
he	up
help	1
le	2
left	3
me	4

menu

button = | do | down | en | enter | he | help | le | left | me | menu | ri | right |
ru | run | up | 1 | 2 | 3 | 4 |

These commands simulate pressing the front panel pushbuttons. The numbers represent the front panel soft keys, from left to right.

Send: push enter
Receive: push enter ok

isc

iscreen

This command retrieves the framebuffer data used for the display on the *iSeries* instrument. It is 19200 bytes in size, 2-bits per pixel, 4 pixels per byte arranged as 320 by 240 characters. The data is sent in RLE encoded form to save time in transmission. It is sent as a type '5' binary C-Link response with no checksum.

The RLE encoding consists of a 0 followed by an 8-bit count of consecutive 0xFF bytes. The following 'c' code will expand the incoming data.

```
void      unpackDisplay ( void far* tdib, unsigned char far* rlescreen )
{
int i,j,k;
unsigned char far *sc4bpp, *sc2bpp, *screen, *ptr;

ptr = screen = (unsigned char far *)malloc(19200);
//RLE decode the screen
for (i=0; i<19200 && (ptr - screen) < 19200; i++)
{
*(ptr++) = *(rlescreen + i);
if (*(rlescreen + i) == 0)
{
unsigned char rlecount = *(unsigned char *) (rlescreen + ++i);

while (rlecount)
{
*(ptr++) = 0;
rlecount--;
}
}
else if (*(rlescreen + i) == 0xff)
{
unsigned char rlecount = *(unsigned char *) (rlescreen + ++i);

while (rlecount)
{
*(ptr++) = 0xff;
rlecount--;
}
}
}
}
```

To convert this data into a BMP for use with windows, it needs to be turned into a 4BPP as that is the smallest windows can display. Also note that BMP files are upside down relative to this data, i.e. the top display line is the last line in the BMP.

menutext

This command displays the text of the menu item where the cursor is currently positioned. The following example shows that the cursor is positioned at the instrument controls menu item.

```
Send:      menutext
Receive:   menu text    main menu    instrument controls
```

sc

screen

This command is meant for backward compatibility on the C series. Screen information is reported using the “iscreen” command above.

```
Send:      screen
Receive:   screen
           This is an I series
           Instrument. Screen
           Information not
           available
```

Measurement Configuration

range no
range no2
range nox
high range no
high range no2
high range nox
low range no
low range no2
low range nox

These commands report NO, NO₂, and NO_x range in single range mode, or the high and low ranges in dual or auto range mode. If the mode is incorrect, the instrument responds with “can’t, wrong settings”. The example below reports that the NO full-scale range is set to 50 ppb, according to [Table B-6](#) and [Table B-7](#).

Send: range no
Receive: range no 0: 5000E-2 ppb

set range Selection
set high range Selection
set low range Selection

These commands select the NO, NO₂, and NO_x full-scale ranges, according to [Table B-6](#) and [Table B-7](#). The example below sets the NO full-scale range to 2,000 ppb.

Send: set range 5
Receive: set range 5 ok

Table B-6. Standard Ranges

Selection	ppb	ppm	µgm ³	mgm ³
0	50	0.05	100	0.1
1	100	0.10	200	0.2
2	200	0.20	500	0.5
3	500	0.50	1,000	1.0
4	1,000	1.00	2,000	2.0
5	2,000	2.00	5,000	5.0
6	5,000	5.00	10,000	10.0
7	10,000	10.00	20,000	20.0
8	20,000	20.00	30,000	30.0
9	C1	C1	C1	C1
10	C2	C2	C2	C2

Selection	ppb	ppm	μgm^3	mgm^3
11	C3	C3	C3	C3

Table B–7. Extended Ranges

Selection	ppb	ppm	μgm^3	mgm^3
0	200	0.2	500	0.5
1	500	0.5	1,000	1
2	1,000	1	2,000	2
3	2,000	2	5,000	5
4	5,000	5	10,000	10
5	10,000	10	20,000	20
6	20,000	20	50,000	50
7	50,000	50	100,000	100
8	100,000	100	150,000	150
9	C1	C1	C1	C1
10	C2	C2	C2	C2
11	C3	C3	C3	C3

custom range

range = | 1 | 2 | 3 |

This command reports the user-defined value of custom range 1, 2, or 3. The example below reports that custom range 1 is defined to 5.50 ppb.

Send: custom 1
Receive: custom 1 550E-2 ppb

set custom range range value

set custom 1 value

set custom 2 value

set custom 3 value

set custom 1 range value

set custom 2 range value

set custom 3 range value

These commands are used to set the maximum concentration for any of the three custom ranges 1, 2, or 3 to range value, where value is a floating-point number representing concentration in ppb ppm, $\mu\text{g}/\text{m}^3$ or mg/m^3 . The example below sets the custom 1 range to 55.5 ppb.

Send: set custom 1 range 55.5
Receive: set custom 1 range 55.5 ok

range mode

This command reports the current range mode.

Send: range mode
Receive: range mode single

set range mode *mode*

This command sets the current range mode to single, dual, or auto. The example below sets the range mode to single.

Send: set range mode single
Receive: set range mode single ok

gas mode

This command reports the current mode of sample, zero, or span. The example below reports that the gas mode is sample.

Send: gas mode
Receive: gas mode sample

set sample

set sample gas

These commands set the zero/span valves to the sample mode. The example below sets the instrument to sample mode, that is, the instrument is reading the sample gas.

Send: set sample
Receive: set sample ok

set zero

set zero gas

These commands set the zero/span valves to the zero mode. The example below sets the instrument to zero mode that is, the instrument is reading the sample gas.

Send: set zero
Receive: set zero ok

set span

set span gas

These commands set the zero/span valves to the span mode. The example below sets the instrument to span mode that is, the instrument is sampling span gas.

Send: set span
Receive: set span ok

gas unit

This command reports the current gas units (ppb, ppm, $\mu\text{g}/\text{m}^3$, or mg/m^3). The example reports that the gas unit is set to ppb.

Send: gas unit
Receive: gas unit ppb

set gas unit *unit*

unit = | ppb | ppm | $\mu\text{g}/\text{m}^3$ | mg/m^3 |

This command sets the gas units to ppb, ppm, $\mu\text{g}/\text{m}^3$, or mg/m^3 . The example below sets the gas units to mg/m^3 .

Send: set gas unit mg/m3
Receive: set gas unit mg/m3 ok

meas mode

This command reports which measurement mode (NO/NO_x, NO, or NO_x) is active. The example below reports that the measurement mode is set to NO.

Send: meas mode
Receive: meas mode no

set meas mode *mode*

mode = | no/nox | no | nox | pre |

This command sets the instrument to NO/NO_x (auto) mode, manual NO mode, or manual NO_x mode. The example below sets the instrument to the manual NO mode.

Send: set meas mode no
Receive: set meas mode no ok

pres comp

This command reports whether pressure compensation is on or off. The example below shows that pressure compensation is on.

Send: pres comp
Receive: pres comp on

set pres comp *onoff*

These commands turn the pressure compensation *on* or *off*. The example below turns pressure compensation off.

Send: set pres comp off
Receive: set pres comp off ok

Hardware Configuration

temp comp

This command reports whether temperature compensation is on or off. The example below shows the temperature compensation is off.

```
Send:      temp comp
Receive:   temp comp off
```

set temp comp *onoff*

These commands turn the temperature compensation *on* or *off*. The example below turns temperature compensation off.

```
Send:      set temp comp off
Receive:   set temp comp off ok
```

contrast

This command reports the screen's level of contrast. The example below shows the screen contrast is 50%, according to [Table B-8](#).

```
Send:      contrast
Receive:   contrast 10:50%
```

set contrast *level*

This command sets the screen's *level* of contrast, according to [Table B-8](#). The example below sets the contrast level to 50%.

```
Send:      set contrast 10
Receive:   set contrast 10 ok
```

Table B-8. Contrast Levels

<i>Level</i>	Contrast Level
0	0%
1	5%
2	10%
3	15%
4	20%
5	25%
6	30%
7	35%
8	40%
9	45%
10	50%
11	55%

<i>Level</i>	Contrast Level
12	60%
13	65%
14	70%
15	75%
16	80%
17	85%
18	90%
19	95%
20	100%

conv set temp

This command reports the temperature that the NO₂ converter is set to. The example below reports that the converter temperature is set to 625 °C.

Send: conv set temp
Receive: conv set temp 625 deg C

set conv set temp *value*

This command sets the temperature that the NO₂ converter is set to, where *value* is an integer representing dwgrees C. The example below sets the converter temperature to 625 °C.

Send: set conv set temp
Receive: set conv set temp 625 deg C ok

date

This command reports the current date. The example below reports the date as December 1, 2004.

Send: date
Receive: date 12-01-04

set date *mm-dd-yy*

mm = month
dd = day
yy = year

This command sets the date of the analyzer's internal clock. The example below sets the date to December 1, 2004.

Send: set date 12-01-04
Receive: set date 12-01-04 ok

set default params

This command sets all the parameters to their default values. This does not affect the factory-calibrated parameters.

Send: set default params
Receive: set default params ok

ozonator

This command reports the ozonator is on or off. The example below reports that the ozonator is on.

Send: ozonator
Receive: ozonator on

set ozonator *onoff*

These commands set the ozonator *on* or *off*. The example below sets the ozonator off.

Send: set ozonator off
Receive: set ozonator off ok

ozonator flow

This command reports the current ozonator flow. The example below reports that the current ozonator flow is 0.050 LPM.

Send: ozonator flow
Receive: ozonator flow 0.050 l/m

ozonator safety

This command reports the status of the ozonator safety on or off. The example below reports that the ozonator safety is on.

Send: ozonator safety
Receive: ozonator safety on

set ozonator safety *onoff*

These commands set the ozonator safety *on* or *off*. The example below sets the ozonator safety off.

Send: set ozonator safety off
Receive: set ozonator safety off ok

ozonator status

This command reports the status of the ozonator and safety. The example below reports that the ozonator is off.

Send: ozonator status
Receive: ozonator status off

pmt status

This command reports the status of the PMT on or off. The example below reports that the PMT is on.

Send: pmt status
Receive: pmt status on

set pmt *onoff*

These commands set the PMT *on* or *off*. The example below turns the PMT off.

Send: set pmt off
Receive: set pmt off ok

save

set save params

This command stores all current parameters in FLASH memory. It is important that each time instrument parameters are changed, that this command be sent. If changes are not saved, they will be lost in the event of a power failure. The example below saves the parameters to FLASH memory.

Send: set save params
Receive: set save params ok

time

This command reports the current time (24-hour time). The example below reports that the internal time is 2:15:30 pm.

Send: time
Receive: time 14:15:30

set time *hh:mm:ss*

hh = hours

mm = minutes

ss = seconds

This command sets the internal clock (24-hour time). The example below sets the internal time to 2:15 pm.

Note If seconds are omitted, the seconds default to 00. ▲

Send: set time 14:15
Receive: set time 14:15 ok

Communications Configuration

addr dns

This command reports the TCP/IP address for the domain name server.

Send: addr dns
Receive: addr dns 192.168.1.1

set addr dns *address*

This command sets the dns *address*, where *address* consists of four numbers ranging from 0-255 inclusive, separated by “.”.

Send: set addr dns 192.168.1.1
Receive: set addr dns 192.168.1.1 ok

addr gw

This command reports the default TCP/IP gateway address.

Send: addr gw
Receive: addr gw 192.168.1.1

set addr gw *address*

This command sets the default gateway *address*, where *address* consists of four numbers ranging from 0-255 inclusive, separated by “.”.

Note This command cannot be used when DHCP is on. Refer to the DHCP command that follows for additional information. ▲

Send: set addr gw 192.168.1.1
Receive: set addr gw 192.168.1.1 ok

addr ip

This command reports the IP address of the analyzer.

Send: addr ip
Receive: addr ip 192.168.1.15

set addr ip *address*

This command sets the analyzer's IP *address*, where *address* consists of four numbers ranging from 0-255 inclusive, separated by “.”.

Note This command cannot be used when DHCP is on. Refer to the DHCP command that follows for additional information. ▲

Send: set addr ip 192.168.1.15
Receive: set addr ip 192.168.1.15 ok

addr nm

This command reports the IP netmask.

```
Send:      addr nm
Receive:   addr nm 255.255.255.0
```

set addr nm *address*

This command sets the nm *address*, where *address* consists of four numbers ranging from 0-255 inclusive, separated by “.”.

Note This command cannot be used when DHCP is on. Refer to the DHCP command that follows for additional information. ▲

```
Send:      set addr nm 255.255.255.0
Receive:   set addr nm 255.255.255.0 ok
```

addr ntp

This command reports the IP address for the network time protocol server. See “Network Time Protocol Servier” in the “Communications Settings” section of the “Operation” chapter for more information.

```
Send:      addr ip
Receive:   addr ip 192.168.1.15
```

set addr ip *address*

This command sets the NTP time server *address*, where *address* consists of four numbers ranging from 0-255 inclusive, separated by “.”.

```
Send:      set addr ip 192.168.1.15
Receive:   set addr ip 192.168.1.15 ok
```

baud

This command reports the current baud rate for the serial port (RS232/RS485). The example below reports that the current baud rate is 9600 baud.

```
Send:      baud
Receive:   baud 9600
```

set baud rate

rate = | 1200 | 2400 | 4800 | 9600 | 19200 | 38400 | 57600 | 115200 |

This command sets the instrument baud rate. The example below sets the instrument’s baud rate to 9600.

Note After the command is sent, the baud rate of the sending device must be changed to agree with the instrument. ▲

```
Send:          set baud 9600
Receive:       set baud 9600 ok
```

dhcp

This command reports the current state of use of the Dynamic Host Configuration Protocol (DHCP) as on or off. DHCP is used to assign an IP address to the instrument automatically. The following example shows that DHCP is on.

```
Send:          dhcp
Receive:       dhcp on
```

set dhcp *onoff*
onoff = | on | off |

This command enables (*on*) and disables (*off*) the DHCP service. When DHCP is set to on, the instrument gets the IP address, the netmask address, and the gateway address from a DHCP server. When DHCP is set to off, the instrument gets these addresses from system memory. The following example sets the DHCP service to on.

Note If DHCP is changed from on to off and then the IP address, the netmask address, or the gateway address is changed, you must cycle power to the instrument before the change takes effect. Until you cycle the power, the address assigned by the DHCP server will still be used and reported as the current address. ▲

```
Send:          set dhcp on
Receive:       set dhcp on ok
```

format

This command reports the current reply termination format. The example below shows that the reply format is 00, which means reply with no checksum, according to [Table B-9](#).

```
Send:          format
Receive:       format 00
```

set format *format*

This command sets the reply termination *format*, where *format* is set according to [Table B-9](#). The example below sets the reply termination format to checksum.

```
Send:          set format 01
Receive:       set format 01 ok
```

Table B–9. Reply Termination Formats

Format	Reply Termination
00	<CR>
01	<NL> sum xxxx <CR>

where xxxx = 4 hexadecimal digits that represent the sum of all the characters (bytes) in the message

host name

This command reports the host name string. The following example reports the host name is set to *iSeries*. This command returns “bad cmd” if no host name has been set.

```
Send:          host name
Receive:       host name iSeries
```

set host name *string*

This command sets the host name *string*, where *string* is 1-13 alphanumeric characters (with no spaces). The following example sets the host name to *analyzer01*. This command returns “bad cmd” if no host name has been set.

```
Send:          set host name analyzer01
Receive:       set host name analyzer01 ok
```

instr name

This command reports the instrument name.

```
Send:          instr name
Receive:       instr name
               NO-NO2-NOx Analyzer
               NO-NO2-NOx Analyzer
```

instrument id

This command reports the instrument id.

```
Send:          instrument id
Receive:       instrument id 42
```

set instrument id *value*

This command sets the instrument id to *value*, where *value* is a decimal number between 0 and 127 inclusive.

Note Sending this command via RS-232 or RS-485 will require the host to use the new id for subsequent commands. ▲

```
Send:      set instrument id 50
Receive:   set instrument id 50 ok
```

mode

This command reports what operating mode the instrument is in: local, service, or remote. The example below shows that the instrument is in the remote mode.

```
Send:      mode
Receive:   mode remote
```

set mode local

set mode remote

These commands set the instrument to local or remote mode. The example below sets the instrument to the local mode.

```
Send:      set mode local
Receive:   set mode local ok
```

allow mode cmd

This command reports the current allow mode setting: 1 = allow “set mode local” or “set mode remote” commands; 0 = ignore “set mode local” or “set mode remote” commands. The default value is 0; ignore the commands (refer to the table that follows). The example that follows shows that the instrument is configured to ignore “set mode local” or “set mode remote” commands.

```
Send:      allow mode cmd
Receive:   allow mode cmd 0
```

set allow mode cmd *value*

This command is used to configure the instrument to value, where value is either 1 = accept or 0 = ignore the “set mode local” and “set mode remote” commands. Refer to the table that follows.

If the instrument is set to accept the commands (*value* = 1), the “set mode local” command will unlock the instrument and the keypad can be used to make changes via the front panel.

If the instrument is set to ignore the commands (*value* = 0), the instrument will respond with “ok” as if the command has been accepted and acted upon, **but will not change the instrument lock status** (this is for compatibility with systems expecting an “ok” response).

Note The instrument will always respond to the command “mode” with the status of the password lock as “mode local” or “mode remote” regardless of the above setting. ▲

The following example sets the instrument to accept the “set mode local” or “set mode remote” commands.

```
Send:          set allow mode cmd 1
Receive:       set allow mode cmd 1 ok
```

Table B–10. Allow Mode Command Values

<i>Value</i>	Allow Mode Command
0	Ignore (default)
1	Accept

power up mode

This command reports the current power up mode setting either 0 = local/unlocked or 1 = remote/locked according to [Table B–11](#). The default value is 0; power up in local/unlocked mode. The following example shows that the instrument is configured to power up in the remote/locked mode.

```
Send:          power up mode
Receive:       power up mode 1
```

set power up mode *value*

This command is used to configure the instrument to power up in the local/unlocked mode (*value* = 0) or the remote/locked mode (*value* = 1), according to [Table B–11](#).

If the instrument is set to power up in the local/unlocked mode, the keypad can be used to make changes via the front panel. If the instrument is set to power up in the remote/locked mode, changes can not be made from the front panel. The example that follows sets the instrument to power up in remote/locked mode.

```
Send:          set power up mode 1
Receive:       set power up mode 1 ok
```

Table B–11. Power Up Mode Values

<i>Value</i>	Power Up Mode Command
0	Local/Unlocked (default)
1	Remote/Locked Mode

program no

This command reports the analyzer’s model information and program version number, which will be dependant on the current version.

Send: program no
Receive: program no iSeries 42i 01.00.01.074

set layout ack

This command reports the stale layout/layout change indicator (*) that is attached to each response if the errec layout has changed since the last time errec layout was requested, according to [Table B–12](#). The following example reports that the instrument is configured to do nothing.

Send: layout ack
Receive: layout ack 0

set layout ack *value*

This command disables the stale layout/layout change indicator (*) that is attached to each response if the errec layout has changed since the last time errec layout was requested, according to [Table B–12](#).

Send: set layout ack
Receive: set layout ack ok

Table B–12. Set Layout Ack Values

Value	Function
0	Do nothing (default)
1	Append "*"

tz

This command reports the “tz” timezone string for the NTP server. See “Network Time Protocol Server” in the “Communications Settings” section of the “Operation” chapter for more information.

Send: tz
Receive: tz EST+5EDT

set tz *string*

This command sets the timezone *string* for the instrument for use with the NTP server, where *string* is a standard timezone string. Common strings are listed in the “Timezone” screen description in Chapter 3.

Send: set tz EST+5EDT
Receive: set tz EST+5EDT ok

I/O Configuration

analog iout range *channel*

This command reports the analog current output range setting for *channels*, where *channel* must be between 1 and 6, inclusive. The example below reports current output channel 4 to the 4-20 mA range, according to [Table](#)

B-13. This command responds with “feature not enabled” if the I/O expansion board is not detected.

Send: analog iout range 4
Receive: analog iout range 4 2

set analog iout range *channel range*

This command sets analog current output *channel* to the *channel range* where *channel* is between 1 and 6 inclusive, and *range* is set according to [Table B-13](#). The example below sets current output channel 4 to the 0-20 mA range. This command responds with “feature not enabled” if the I/O expansion board is not detected.

Send: set analog iout range 4 1
Receive: set analog iout range 4 1 ok

Table B-13. Analog Current Output Range Values

Range	Output Range
1	0-20 mA
2	4-20 mA
0 [cannot be set to this, but may report]	Undefined

analog vin *channel*

This command retrieves the analog voltage input *channel* data, both the calculated value and the actual voltage. In the example below, the “calculated” value of channel 1 is 75.325 degrees F, volts are 2.796. This command responds with “feature not enabled” if the I/O expansion board is not detected.

Send: analog vin 1
Receive: analog vin 1 75.325 2.796

analog vout range *channel*

This command reports the analog voltage output *channel range*, where *channel* is between 1 and 6 inclusive, according to [Table B-14](#).

Send: analog vout range 2
Receive: analog vout range 2 3

set analog vout range *channel range*

This command sets analog voltage output *channel* to the range, where *channel* is between 1 and 6 inclusive, and *range* is set according to [Table B-14](#). The example below sets channel 2 to the 0-10 V range.

```
Send:          set analog vout range 2 3
Receive:       set analog vout range 2 3 ok
```

Table B–14. Analog Voltage Output Range Values

Range	Output Range
1	0-1 V
2	0-100 mV
3	0-10 V
4	0-5 V
0 [cannot be set to this, but may report]	Undefined

dig in

This command reports the status of the digital inputs as a 4-digit hexadecimal string with the most significant bit (MSB) being input 16.

```
Send:          dig in
Receive:       dig in 0xff7f
```

din channel

This command reports the action assigned to the digital input *channel* and index number of the corresponding active state. The following example reports input 5 to be assigned an index number 9 corresponding to action of “analog outputs to zero” with the active state being high.

```
Send:          din 5
Receive:       din 5 9 AOUTS TO ZERO high
```

set din channel index state

This command assigns digital input *channel* (1-16) to activate the action indicated by *index* (1-35), when the input transitions to the designated *state* (high or low). Use the “list din var” command to obtain the list of supported *index* values and corresponding actions. The following example sets the digital input channel 1 to 3 on a low-to-high transition.

```
Send:          set din 1 3 high
Receive:       set din 1 3 high ok
```

dout channel

This command reports the index number, output variable and the active state assigned to digital output *channel*. The following example reports output 4 to be assigned an index number 11 corresponding to action of “general alarm”.

```
Send:      dout 4
Receive:   dout 4 11 GEN ALARM open
```

set dout *channel index state*

This command assigns digital output *channel* to be assigned to the action associated with *index*, and assigns it an active state of *state* (open or closed). Use the “list var dout” command to obtain the list of supported index values and corresponding state. The following example sets the digital output channel 4 to state 11.

```
Send:      set dout 4 11 open
Receive:   set dout 4 11 open ok
```

dtoa *channel*

This command reports the outputs of the 6 or 12 Digital to Analog converters, according to [Table B–15](#). The following example shows that the D/A #1 is 97.7% full-scale.

```
Send:      dtoa 1
Receive:   dtoa 1 97.7%
```

Note If the instrument is in a mode which does not provide a particular output, and that output is selected, the value will be 0.0. ▲

All channel ranges are user definable. If any customization has been made to the analog output configuration, the default selections may not apply. ▲

Table B–15. Default Output Assignment

D to A	Function	Single Range	Dual Range	Auto Range
1	Voltage Output	NO	High NO	High/Low NO
2	Voltage Output	NO ₂	High NO ₂	High/Low NO ₂
3	Voltage Output	NO _x	High NO _x	High/Low NO _x
4	Voltage Output	Not Used	Low NO	Range (NO _x)
5	Voltage Output	Not Used	Low NO ₂	Not Used
6	Voltage Output	Not Used	Low NO _x	Not Used
7	Current Output	NO	High NO	High/Low NO
8	Current Output	NO ₂	High NO ₂	High/Low NO ₂
9	Current Output	NO _x	High NO _x	High/Low NO _x
10	Current Output	Not Used	Low NO	Range (NO _x)
11	Current Output	Not Used	Low NO ₂	Not Used
12	Current Output	Not Used	Low NO _x	Not Used

list var aout
list var dout
list var din

These commands report the list of index numbers, and the variables (associated with that index number) available for selection in the current mode (determined by single/dual/auto, gas mode) for analog output, digital output and digital inputs. The index number is used to insert the variable in a field location in a list using “set sp *field index*”. The example below reports the list of analog output, index numbers, and variables.

```
Send:      list var aout
Receive:   list var aout
           index variable
           0 none
           1 no
           2 no2
           3 nox
           18 intt
           19 rctt
           20 pmtt
           21 convt
           25 pres
           26 smp1f
           27 pmtv
           28 ain1
           29 ain2
           30 ain3
           31 ain4
           32 ain5
           33 ain6
           34 ain7
           35 ain8
```

mb read coils *start count*

start = index of first coil, *count* = number of coils to report

This command reports the current state of the MODBUS coils (digital outputs). Output is in binary format with the coil *start* appearing as the right-most bit.

```
Send:      mb read coils 1 15
Receive:   mb read coils 1 15 000000100000001
```

mb read registers *start count*

start = index of first register (must be odd number), *count* = number of registers to report (must be even), each pair of registers is reported as a float.

This command reports the current state of the MODBUS registers (analog outputs). Output is in floating point format with the pair of registers *start* and *start+1* appearing as the left-most bit.

```
Send:          mb read registers 5 4
Receive:       mb read registers 5 4 552629.000000 55998800.000000
```

set mb write coil *coil state*

coil = index of coil to be set, *state* = 1 or 0

This command sets the current state of the MODBUS coil *coil* (digital input). *coil* has an offset of 100 (that is, the first write coil is address 101).

```
Send:          set mb write coil 104 1
Receive:       set mb write coil 104 1 ok
```

relay stat

This command reports the current relay logic normally “open” or normally “closed,” if all the relays are set to same state, that is all open or all closed. The example below shows that the status when all the relays logic is set to normally “open”.

```
Send:          relay stat
Receive:       relay stat open
```

Note If individual relays have been assigned different logic then the response would be a 4-digit hexadecimal string with the least significant byte (LSB) being relay no 1. ▲

For example:

```
Receive:       relay stat 0x0001 (indicates relay no 1 is set to
normally open logic, all others are normally closed)
Receive:       relay stat 0x0005 (indicates relay no 1 and 3 are set
to be normally open logic, all others are normally
closed)
```

set relay open

set relay open *value*

set relay closed

set relay closed *value*

These commands set the relay logic to normally open or closed for relay number *value*, where *value* is the relay between 1 and 16. The example below sets the relay no 1 logic to normally open.

Note If the command is sent without an appended relay number then all the relays are assigned the set logic of normally open/closed. ▲

```
Send:          set relay open 1
Receive:       set relay open 1 ok
```

Record Layout Definition

The Erec, Lrec Srec layouts contain the following:

- A format specifier for parsing ASCII responses
- A format specifier for parsing binary responses

In addition to these the Erec Layout contains:

- A format specifier for producing the front-panel displays

Values are read in using either the ASCII or binary format specifiers and converted to uniform internal representations (32-bit floats or 32-bit integers). These values are converted into text for display on the screen using the format specifier for the front-panel display. Normally, the specifier used to parse a particular datum from the input stream will be strongly related to the specifier used to display it (such as, all of the floating point inputs will be displayed with an 'f' output specifier, and all of the integer inputs will be displayed with a 'd' specifier).

Format Specifier for ASCII Responses

The first line of the Layout response is the scanf-like parameter list for parsing the fields from an ASCII ERec response. Parameters are separated by spaces and the line is terminated by a \n (the normal line separator character). Valid fields are:

- %s - parse a string
- %d - parse a decimal number
- %ld - parse a long (32-bit) decimal number
- %f - parse a floating point number
- %x - parse a hexadecimal number
- %lx - parse a long (32-bit) hex number
- %* - ignore the field

Note Signed versus unsigned for the integer values does not matter; it is handled automatically. ▲

Format Specifier for Binary Responses

The second line of the Layout response is the binary parameter list for parsing the fields from a binary response. Parameters MUST be separated by spaces, and the line is terminated by a '\n'. Valid fields are:

- t - parse a time specifier (2 bytes)
- D - parse a date specifier (3 bytes)
- i - ignore one 8-bit character (1 byte)
- e - parse a 24-bit floating point number (3 bytes: n/x)
- E - parse a 24-bit floating point number (3 bytes: N/x)
- f - parse a 32-bit floating point number (4 bytes)

- c - parse an 8-bit signed number (1 byte)
- C - parse an 8-bit unsigned number (1 byte)
- n - parse a 16-bit signed number (2 bytes)
- N - parse a 16-bit unsigned number (2 bytes)
- m - parse a 24-bit signed number (3 bytes)
- M - parse a 24-bit unsigned number (3 bytes)
- l - parse a 32-bit signed number (4 bytes)
- L - parse a 32-bit unsigned number (4 bytes)

There is an optional single digit d which may follow any of the numeric fields which indicates that after the field has been parsed out, the resulting value is to be divided by 10^d . Thus the 16-bit field 0xFFC6 would be interpreted with the format specifier 'n3' as the number -0.058.

Format Specifier for EREC Layout

The subsequent lines in the ERec Layout response describe the appearance of the full panel. The full instrument panel as it appears on the screen has two columns of lines. Each line is composed of three major components: (1) a text field, (2) a value field, and (3) a button. None of these three components is required. The text field contains statically displayed text.

The value field displays values which are parsed out of the response to a DATA/ERec command. It also displays, though background changes, alarm status. The button, when pressed, triggers input from either a dialog box or a selection list. There are five kinds of buttons, B, I, L, T, and N.

Each line in the layout string corresponds to one line on the display. The layout string describes each of the three major fields as well as translation mechanisms and corresponding commands.

Text The first field in the layout string is the text. It is delimited by a ':'. The string up to the first ':' will be read and inserted in the text field of the line.

Value String This is followed by a possible string enclosed in quotes that is used to place a string into the value field.

Value Source The value source, which is the item (or word) number in the DATA/ERec response, appears next. This is followed by an optional bitfield designator. The datum identified by the value source can be printed as a string 's', hexadecimal 'x', decimal 'd', or floating point 'f', or binary 'b' number. Typically, bitfield extractions are only done for decimal or hexadecimal numbers.

Floating-point numbers can be followed with an optional precision specifier which will be used as an argument to printf's %f format (e.g., a field of '4' would be translated into the printf command of '%.3f'). Alternately, the special character '*' can precede the precision specifier; this causes an indirection on the precision specifier (which now becomes a field number).

This is useful when formatting, for example, numbers which have varying precision depending on the mode of the instrument.

Binary numbers can also have an optional precision specifier which is used to determine how many bits to print. For example, the specifier 'b4' will print the lowest four bits of the parsed number.

There are serious restrictions on where an 's' field may appear: currently sources 1 and 2 must be 's', and no others may be 's'.

Alarm Information The value source is followed by optional alarm information, indicated by a commercial at sign '@' with a source indicator and a starting bit indicator. All alarm information is presumed to be two bits long (low and high). The bitfield extraction is performed on the integer part of the source. Typical alarm information would appear as '@6.4'.

Translation Table Then, there appears an optional translation table within braces '{}'. This is a string of words separated by spaces. An example translation table would be '{Code_0 Code_1 Code_2 Code_3}'. The value, once extracted is used as a zero-based index into the translation table to determine the string to display.

Selection Table Then there appears an optional selection table within parentheses '(...)'. This is a string of numbers separated by spaces '(0 1)'. The selection table

lists the translation table entries which the user may select from when setting the parameter. This is not necessarily the same as the entries which may be displayed.

Button Designator

Then there appears an optional button designator. This will be one of 'B', 'I', 'L', 'T', or 'N'.

B—Indicates a button which pops up an input dialog prompting the user for a new value using the designated input format. The input format is specified from the 'B' through the subsequent semicolon.

I—Indicates a button which pops up a selection list with input translation. That is, the values read are translated before they are compared to the selection list options.

L—Indicates a button which pops up a selection list without any translation. The output value is number of the selected option.

T—Indicates a button which pops up a selection list with output translation. The number of the option selected is used as an index into the translation table to generate an output string.

N—Indicates a button which only sends the subsequent command to the instrument. No user-prompting happens.

The following string through an optional '|' or the end of the line is the command which is to be sent to the instrument upon the completion of the button selection. The command string should normally contain print-style formatting to include the user input. If a '|' is present, it indicates a command which is sent to the instrument upon successful completion of the button command to update the value field.

This is not currently used.

Examples Some examples ('\n' is the C syntax for an end-of-line character):

```
'Concentrations\n'
```

This is a single text-only line.

```
'\n'
```

This is a single blank line.

```
' NO:3s\n'
```

This is a line which appears slightly indented. The text field is 'NO', the value is taken from the third element of the data response, and interpreted as a string.

```
' NO:18sBd.ddd;set no coef %s\n'
```

This is a line which also appears slightly indented. The next field is also 'NO', but the value is taken from the eighteenth element of the data response, again interpreted as a string. A button appears on this line which, when pressed, pops up an input dialog which will state "Please enter a new value for NO using a d.ddd format." The string entered by the user is used to construct the output command. If the user enters, for example, '1.234', the constructed command will be 'set no coef 1.234'.

```
' NO:21f{Code_0 Code_1 Code_2 Code_3 Code_4 Code_5 Code_6  
Code_7 Code_8 Code_9 Code_10 Code_11}Lset range no %d\n'
```

This is a line which appears slightly indented, the title is again 'NO', and the value the twenty-first element of the data response, interpreted as a floating-point number. There is a no-translation button which creates a selection list of twelve "Code nn" options. The number of the user selection is used to create the output command.

```
'Mode:6.12-13x{local remote service service}(0 1)Tset mode  
%s\n'
```

This is a line which has a title of 'Mode', and value taken from the sixth field of the data response. There is a bitfield extraction of bits 12 through 13 from the source (the value type is not important here because the value is being translated to an output string). Once the bits have been extracted, they are shifted down to the bit-zero position. Thus, the possible values of this example will be 0 through 3. The translation list shows the words which correspond to each input value, the zeroth value appearing first (0 -> local, 1 -> remote, etc.). The selection list shows that only the first two values, in this case, are to be shown to the user when the button is pressed. The 'T' button indicates full translation, input code to string, and user selection number to output string.

```
'\xC'
```

This is a line that starts a new column (the \xC or ^L),

```
' Comp:6.11x{off on}Tset temp comp %s\n'
```

This shows that the bitfield end (the second part of a bitfield specification) is optional. The bitfield will be one bit long, starting in this case at the eleventh bit.

```
'Background:7f*8Bd.ddd;set o3 bkg %s\n'
```

This shows the use of indirect precision specifiers for floating point displays. The background value is taken from the 7th element, and the precision specifier is taken from the 8th. If the asterisk were not present, it would indicate instead that 8 digits after the decimal point should be displayed.

Appendix C

MODBUS Protocol

This appendix provides a description of the MODBUS Protocol Interface and is supported both over RS-232/485 (RTU protocol) as well as TCP/IP over Ethernet.

The MODBUS Commands that are implemented are explained in detail in this document. The MODBUS protocol support for the *iSeries* enables the user to perform the functions of reading the various concentrations and other analog values or variables, read the status of the digital outputs of the analyzer, and to trigger or simulate the activation of a digital input to the instrument. This is achieved by using the supported MODBUS parameters listed below.

For details of the Model 42*i* MODBUS Protocol specification, see the following topics:

- “Serial Communication Parameters” on page C-1
- “TCP Communication Parameters” on page C-2
- “Application Data Unit Definition” on page C-2
- “Function Codes” on page C-3
- “MODBUS Parameters Supported” on page C-8

Additional information on the MODBUS protocol can be obtained at <http://www.modbus.org>. References are from MODBUS Application Protocol Specification V1.1a MODBUS-IDA June 4, 2004.

Serial Communication Parameters

The following are the communication parameters that are used to configure the serial port of the *iSeries* to support MODBUS RTU protocol.

Number of Data bits	: 7 or 8
Number of Stop bits	: 1 or 2
Parity	: None, Odd, or Even
Data rate	: 1200 to 115200 Baud (9600 is default)

TCP Communication Parameters

*i*Series Instruments support the MODBUS/TCP protocol. The register definition is the same as for the serial interface. Up to three simultaneous connections are supported over Ethernet.

TCP connection port for MODBUS : 502

Application Data Unit Definition

Here are the MODBUS ADU (Application Data Unit) formats over serial and TCP/IP:

Serial:	Slave Address	Function Code	Data	Error Check
TCP/IP:	MBAP Header	Function Code	Data	

Slave Address

The MODBUS slave address is a single byte in length. This is the same as the instrument ID used for C-Link commands and can be between 1 and 127 decimal (i.e. 0x01 hex to 0x7F hex). This address is only used for MODBUS RTU over serial connections.

Note Device ID '0' used for broadcast MODBUS commands, is not supported. Device IDs 128 through 247 (i.e. 0x80 hex to 0xF7 hex) are not supported because of limitations imposed by C-Link. ▲

MBAP Header

In MODBUS over TCP/IP, a MODBUS Application Protocol Header (MBAP) is used to identify the message. This header consists of the following components:

Transaction Identifier	2 Bytes	0x0000 to 0xFFFF (Passed back in response)
Protocol Identifier	2 Bytes	0x00 (MODBUS protocol)
Length	2 Bytes	0x0000 to 0xFFFF (Number of following bytes)
Unit Identifier	1 Byte	0x00 to 0xFF (Passed back in response)

A Slave address is not required in MODBUS over TCP/IP because the higher-level protocols include device addressing. The unit identifier is not used by the instrument.

Function Code

The function code is a single byte in length. The following function codes are supported by the instrument:

Read Coils	:	0x01
Read Inputs	:	0x02
Read Holding Registers	:	0x03
Read Input Registers	:	0x04
Force (Write) Single Coil	:	0x05
Read Exception Status	:	0x06

If a function code is received that is not in this list, an invalid function exception is returned.

Data

The data field varies depending on the function. For more description of these data fields, see “Function Codes” below.

Error Check

In MODBUS over Serial an error check is included in the message. This is not necessary in MODBUS over TCP/IP because the higher-level protocols ensure error-free transmission. The error check is a two-byte (16 bit) CRC value.

Function Codes

This section describes the various function codes that are supported by the Model 42i.

(0x01/0x02) Read Coils / Read Inputs

Read Coils / Inputs read the status of the digital outputs (relays) in the instrument. Issuing either of these function codes will generate the same response.

These requests specify the starting address, i.e. the address of the first output specified, and the number of outputs. The outputs are addressed starting at zero. Therefore, outputs numbered 1–16 are addressed as 0–15.

The outputs in the response message are packed as one per bit of the data field. Status is indicated as 1 = Active (on) and 0 – Inactive (off). The LSB of the first data byte contains the output addressed in the query. The other outputs follow toward the high end of this byte, and from low order to high order in subsequent bytes. If the returned output quantity is not a multiple of eight, the remaining bits in the final data byte will be padded with zeros (toward the high order end of the byte). The Byte Count field specifies the quantity of complete bytes of data.

Note The values reported may not reflect the state of the actual relays in the instrument, as the user may program these outputs for either active closed or open. ▲

Request

Function code	1 Byte	0x01 or 0x02
Starting Address	2 Bytes	0x0000 to maximum allowed by instrument
Quantity of outputs	2 Bytes	1 to maximum allowed by instrument
Unit Identifier	1 Byte	0x00 to 0xFF (Passed back in response)

Response

Function code	1 Byte	0x01 or 0x02
Byte count	1 Byte	N*
Output Status	n Byte	N = N or N+1

*N = Quantity of Outputs / 8, if the remainder not equal to zero, then N=N+1

Error Response

Function code	1 Byte	0x01 or 0x02
Exception code	1 Byte	01=Illegal Function, 02=Illegal Address, 03=Illegal Data, 04=Slave Device Failure

Here is an example of a request and response to read outputs 2–15:

Request

<i>Field Name</i>	<i>(Hex)</i>
Function	0x01
Starting Address Hi	0x00
Starting Address Lo	0x02
Quantity of Outputs Hi	0x00
Quantity of Outputs Lo	0x0D

Response

<i>Field Name</i>	<i>(Hex)</i>
Function	0x01
Byte Count	0x03
Output Status 2–10	0xCD
Output Status 11–15	0x0A

The status of outputs 2–10 is shown as the byte value 0xCD, or binary 1100 1101. Output 10 is the MSB of this byte, and output 2 is the LSB. By convention, bits within a byte are shown with the MSB to the left, and the LSB to the right. Thus, the outputs in the first byte are '10 through 2', from left to right. In the last data byte, the status of outputs 15-11 is shown as the byte value 0x0A, or binary 0000 1010. Output 15 is in the fifth bit position from the left, and output 11 is the LSB of this byte. The four remaining high order bits are zero filled.

(0x03/0x04) Read Holding Registers / Read Input Registers

Read holding / input registers reads the measurement data from the instrument. Issuing either of these function codes will generate the same response. These functions read the contents of one or more contiguous registers.

These registers are 16 bits each and are organized as shown below. All of the values are reported as 32-bit IEEE standard 754 floating point format. This uses 2 sequential registers, least significant 16 bits first.

The request specifies the starting register address and the number of registers. Registers are addressed starting at zero. Therefore, registers numbered 1–16 are addressed as 0–15. The register data in the response message are packed as two bytes per register, with the binary contents right justified within each byte. For each register, the first byte contains the high order bits and the second contains the low order bits.

Request

Function code	1 Byte	0x03 or 0x04
Starting Address	2 Bytes	0x0000 to maximum allowed by instrument
Quantity of Registers	2 Bytes	1 to maximum allowed by instrument

Response

Function code	1 Byte	0x03 or 0x04
Byte count	1 Byte	2 x N*
Register value	N* x 2 Bytes	N = N or N+1

*N = Quantity of Registers

Error Response

Function code	1 Byte	Function code + 0x80
Exception code	1 Byte	01=Illegal Function, 02=Illegal Address, 03=Illegal Data, 04=Slave Device Failure

Here is an example of a request and response to read registers 10–13:

Request

<i>Field Name</i>	<i>(Hex)</i>
Function	0x03
Starting Address Hi	0x00
Starting Address Lo	0x09
No. of Registers Hi	0x00
No. of Registers Lo	0x04

Response

<i>Field Name</i>	<i>(Hex)</i>
Function	0x03
Byte Count	0x06
Register value Hi (10)	0x02
Register value Lo (10)	0x2B
Register value Hi (11)	0x00

Register value Lo (11)	0x00
Register value Hi (12)	0x00
Register value Lo (12)	0x64
Register value Hi (13)	0x00
Register value Lo (13)	0x64

The contents of register 10 are shown as the two byte values of 0x02 0x2B. Then contents of registers 11–13 are 0x00 0x00, 0x00 0x64 and 0x00 0x64 respectively.

(0x05) Force (Write) Single Coil

The force (write) single coil function simulates the activation of the digital inputs in the instrument, which triggers the respective action.

This function code is used to set a single action to either ON or OFF. The request specifies the address of the action to be forced. Actions are addressed starting at zero. Therefore, action number 1 is addressed as 0. The requested ON/OFF state is specified by a constant in the request data field. A value of 0xFF00 requests the action to be ON. A value of 0x0000 requests it to be OFF. All other values are illegal and will not affect the output. The normal response is an echo of the request, returned after the state has been written.

Note This function will not work if the instrument is in service mode. ▲

Request

Function code	1 Byte	0x05
Starting Address	2 Bytes	0x0000 to maximum allowed by instrument
Output Value	2 Bytes	0x0000 or 0xFF00

Response

Function code	1 Byte	0x05
Starting Address	2 Bytes	0x0000 to maximum allowed by instrument
Output Value	2 Bytes	0x0000 or 0xFF00

Error Response

Function code	1 Byte	Function code + 0x80
---------------	--------	----------------------

Coil Number	Status	
3	SERVICE	
4	UNITS	
5	ZERO MODE	Zero/Span Option
6	SPAN MODE	Zero/Span Option
7	NO MODE	
8	NO _x MODE	
9	NOT USED	
10	NOT USED	
11	GEN ALARM	
12	NO CONC MAX ALARM	
13	NO CONC MIN ALARM	
14	NO ₂ CONC MAX ALARM	
15	NO ₂ CONC MIN ALARM	
16	NO _x CONC MAX ALARM	
17	NO _x CONC MIN ALARM	
18	NOT USED	
19	NOT USED	
20	NOT USED	
21	NOT USED	
22	INT TEMP ALARM	
23	CHAMB TEMP ALARM	
24	COOLER TEMP ALARM	
25	NO ₂ CONVERTER TEMP ALARM	
26	NOT USED	
27	PERM OVEN GAS TEMP ALARM	Perm Span Option
28	PRESSURE ALARM	
29	FLOW ALARM	Bypass Flow Option
30	OZONE FLOW ALARM	
31	MOTHERBOARD STATUS ALARM	
32	INTERFACE BD STATUS ALARM	
33	I/O EXP BD STATUS ALARM	I/O Expansion Board Option
34	NOT USED	
35	CONC ALARM	
36	SAMPLE MODE	

MODBUS Protocol

MODBUS Parameters Supported

Coil Number	Status	
37	PURGE MODE	Zero/Span Option
38	NOT USED	
39	ZERO CHECK/CAL ALARM	Zero/Span Option
40	SPAN CHECK/CAL ALARM	Zero/Span Option
41	O ₂ SENSOR ALARM	Internal O ₂ Sensor Option
42	NOT USED	
43	NOT USED	
44	NOT USED	
45	NOT USED	
46	NOT USED	
47	NOT USED	
48	NOT USED	
49	NOT USED	
50	NOT USED	
51	NOT USED	
52	NOT USED	
53	NOT USED	
54	NOT USED	
55	NOT USED	
56	NOT USED	
57	NOT USED	
58	NOT USED	
59	NOT USED	
60	EXT ALARM 1	
61	EXT ALARM 2	
62	EXT ALARM 3	

In addition to the coils listed in the Read Coils table, coils in the Write Coils table can also be read.

IMPORTANT NOTE The addresses in the following tables are Protocol Data Unit (PDU) addresses. Verify the register number on your MODBUS master to ensure that it matches the register number on the instrument. ▲

Note For additional information on how to read registers and interpret the data, refer to the “(0x03/0x04) Read Holding Registers / Read Input Registers” section in this appendix. ▲

Table C–2. Read Registers for 42i

Register Number	Variable	
0	NOT USED	
1 & 2	NO	
3 & 4	NO2	
5 & 6	NOx	
7 & 8	NOT USED	
9 & 10	NOT USED	
11 & 12	LOW NO	
13 & 14	LOW NO2	
15 & 16	LOW NOx	
17 & 18	NOT USED	
19 & 20	NOT USED	
21 & 22	HIGH NO	
23 & 24	HIGH NO2	
25 & 26	HIGH NOx	
27 & 28	NOT USED	
29 & 30	NOT USED	
31 & 32	RANGE (NOx)	
33 & 34	NOT USED	
35 & 36	INTERNAL TEMPERATURE	
37 & 38	CHAMBER TEMPERATURE	
39 & 40	COOLER TEMPERATURE	
41 & 42	NO2 CONVERTER TEMP	
43 & 44	NOT USED	
45 & 46	PERM OVEN GAS	Perm Span Option
47 & 48	PERM OVEN HEATER	Perm Span Option
49 & 50	CHAMBER PRESSURE	
51 & 52	SAMPLE FLOW	Bypass Flow Option
53 & 54	PMT VOLTS	

MODBUS Protocol

MODBUS Parameters Supported

Register Number	Variable	
55 & 56	ANALOG IN 1/NO BKG**	I/O Expansion Board Option*
57 & 58	ANALOG IN 2/NOx BKG**	I/O Expansion Board Option*
59 & 60	ANALOG IN 3/LO NO COEF**	I/O Expansion Board Option*
61 & 62	ANALOG IN 4/LO NO2 COEF**	I/O Expansion Board Option*
63 & 64	ANALOG IN 5/LO NOx COEF**	I/O Expansion Board Option*
65 & 66	ANALOG IN 6/HI NO COEF**	I/O Expansion Board Option*
67 & 68	ANALOG IN 7/HI NO2 COEF**	I/O Expansion Board Option*
69 & 70	ANALOG IN 8/HI NOx COEF**	I/O Expansion Board Option*
71 & 72	OZONATOR FLOW	
73 & 74	NOT USED	
75 & 76	NOT USED	
77 & 78	NOT USED	
79 & 80	NO CORRECTION CONC	O ₂ Sensor Option
81 & 82	NO2 CORRECTION CONC	O ₂ Sensor Option
83 & 84	NOx CORRECTION CONC	O ₂ Sensor Option
85 & 86	NOT USED	
87 & 88	NOT USED	
89 & 90	LOW NO CORRECTION CONC	O ₂ Sensor Option
91 & 92	LOW NO2 CORRECTION CONC	O ₂ Sensor Option
93 & 94	LOW NOx CORRECTION CONC	O ₂ Sensor Option
95 & 96	NOT USED	
97 & 98	NOT USED	
99 & 100	HIGH NO CORRECTION CONC	O ₂ Sensor Option
101 & 102	HIGH NO2 CORRECTION CONC	O ₂ Sensor Option
103 & 104	HIGH NOx CORRECTION CONC	O ₂ Sensor Option
105 & 106	NOT USED	
107 & 108	NOT USED	
109 & 110	NOT USED	
111 & 112	O ₂ %	Internal O ₂ Sensor Option
113 & 114	O ₂ SENS TEMP	Internal O ₂ Sensor Option
115 & 116	NOT USED	
117 & 118	NOT USED	
119 & 120	NOT USED	

Register Number	Variable
121 & 122	EXT ALARMS

*The analog inputs 1–8 will not show if the Output Conc Cal option is set to YES in the Instrument Configuration screen.

**BKG and COEF items are displayed only if Output Conc Cal option is set to YES in the Instrument Configuration screen.

IMPORTANT NOTE The addresses in the following tables are Protocol Data Unit (PDU) addresses. Verify the coil number on your MODBUS master to ensure that it matches the coil number on the instrument. ▲

Note Writing 1 to the coil number shown in the following table will initiate the “action triggered” listed in the table. This state must be held for at least 1 second to ensure the instrument detects the change and triggers the appropriate action. ▲

Note The coils within each coil group in the following table are mutually exclusive and will not be triggered if there is conflict. Before you assert (1) one coil in a group, make sure the other coils in the group are de-asserted (0). ▲

Table C–3. Write Coils for 42i

Coil Number	Action Triggered	Coil Group	
100	NOT USED		
101	ZERO MODE	Zero/Span Mode	Zero/Span Option
102	SPAN MODE	Zero/Span Mode	Zero/Span Option
103	NO MODE	Measure Mode	
104	NOX MODE	Measure Mode	
105	NOT USED		
106	NOT USED		
107	SET BACKGROUND		
108	CAL TO LO SPAN		
109	AOUTS TO ZERO	Analog Out Test	I/O Expansion Board Option
110	AOUTS TO FS	Analog Out Test	I/O Expansion Board Option
111	CAL TO HI SPAN		
112	NOT USED		
113	NOT USED		

MODBUS Protocol

MODBUS Parameters Supported

Coil Number	Action Triggered	Coil Group
114	NOT USED	
115	NOT USED	
116	NOT USED	
117	EXT ALARM 1	
118	EXT ALARM 2	
119	EXT ALARM 3	
120	NOT USED	

Reading a Write Coil

To read a write coil, issue a read coil command for that coil. For example, to view the state of write coil 101, issue a “read coil 101”.

Appendix D

Geysitech (Bayern-Hessen) Protocol

This appendix provides a description of the Geysitech (Bayern-Hessen or BH) Protocol Interface and is supported both over RS-232/485 as well as TCP/IP over Ethernet.

The Geysitech Commands that are implemented are explained in detail in this document. The Geysitech protocol support for the *iSeries* enables the user to perform the functions of reading the various concentrations and to trigger the instrument to be in sample/zero/span mode if valid for that instrument. This is achieved by using the supported Geysitech commands listed below.

For details of the Model 42*i* Geysitech Protocol specification, see the following topics:

- “Serial Communication Parameters” on page D-1
- “TCP Communication Parameters” on page D-2
- “Instrument Address” on page D-2
- “Abbreviations Used” on page D-2
- “Basic Command Structure” on page D-2
- “Block Checksum” on page D-3
- “Geysitech Commands” on page D-2

Serial Communication Parameters

The following are the communication parameters that are used to configure the serial port of the *iSeries* to support Geysitech protocol.

Number of Data bits	: 7 or 8
Number of Stop bits	: 1 or 2
Parity	: None, Odd, or Even
Data rate	: 1200 to 115200 Baud (9600 is default)

TCP Communication Parameters

iSeries Instruments support the Geysitech/TCP protocol over TCP/IP. The register definition is the same as for the serial interface. Up to three simultaneous connections are supported over Ethernet.

TCP connection port for Geysitech: 9882

Instrument Address

The Geysitech instrument address has a value between 0 and 127 and is represented by 3 digit ASCII number with leading zeros or leading spaces if required (e.g. Instrument address of 1 is represented as 001 or <SP><SP>1)

The instrument Address is the same as the Instrument ID used for C-Link and MODBUS commands. This can be set via the front panel.

The Instrument Address is represented by <address> in the examples throughout this document.

Note Device IDs 128 through 247 are not supported because of limitations imposed by the C-Link protocol. ▲

Abbreviations Used

The following is a list of abbreviations used in this document:

<CR> is abbreviation for Carriage Return (ASCII code 0x0D)

<STX> is abbreviation for Start of Text (ASCII code 0x02)

<ETX> is abbreviation for End of Text (ASCII code 0x03)

<SP> is abbreviation for space (ASCII code 0x20)

Basic Command Structure

The following is the basic structure of a Geysitech command:

<STX>Command text<ETX><BCC>

OR

<STX>Command text<CR>

Each command is framed by control characters, <STX> at the start and terminated with either <ETX> or <CR>.

If a command is terminated with <ETX>, then two additional characters <BCC> is attached after <ETX>. This is the block checksum.

Block Checksum Characters <BCC> may be added to the command to prevent processing invalid commands.

Block Checksum Characters <BCC>

The Block Checksum Characters are calculated beginning with a seed value of 00000000, binary (0x00), and bitwise exclusive ORing with each of the characters of the command string (or response) including the framing characters <STX> and <ETX>. The checksum works as an error check. The command terminator determines the presence or absence of <BCC>.

If a command is terminated by <ETX> then the next two characters are the checksum, if the command is terminated with <CR> no checksum is attached.

The block checksum is represented by two characters, which represent a 2 digit hex number (1byte) (e.g. 1 byte 0xAB hex checksum will be represented by the two characters 'A' & 'B').

The checksum is referred to as <BCC> throughout this document.

Geositech Commands

The following commands are supported by the Geositech protocol:

- Instrument Control Command (ST)
- Data Sampling/Data Query Command (DA)

Instrument Control Command (ST)

There are three control commands supported by the Geositech protocol.

This <control command> is a single letter, which triggers an action in the instrument. These commands are active only when service mode is inactive and the zero/span option is present.

Command 'N' switches the instrument gas mode to Zero mode.

Command 'K' switches the instrument gas mode to Span mode.

Command 'M' switches the instrument gas mode to Sample mode.

The following are the different acceptable formats of the ST command:

<STX>ST<address><control command><ETX><BCC>

OR

<STX>ST<address><control command><CR>

OR

<STX>ST<address><SP><control command><CR>

OR

<STX>ST<address><SP><control command><ETX><BCC>

The <address> is optional, which means it can be left out completely. The <address> if present must match the Instrument Address. Additional space can be present after the <address>.

If the received command does not satisfy the above formats or if the <address> does not match the Instrument Address the command is ignored.

This is a sample command to switch the instrument to zero mode, instrument id 5:

```
<STX>ST005<SP>N<CR>
```

Data Sampling/Data Query Command (DA)

This command DA initiates a data transfer from the instrument. The instrument responds with measurement data, which depends on the range mode and is listed in “[Measurements reported in response to DA command](#)” below.

The command structure for a data query command is as follows:

```
<STX>DA<address><ETX><BCC>
```

The <address> is optional, which means it can be left out completely. The <address> if present must match the Instrument Address. Additional space can be present after the <address>.

If the <address> is left out then no space is allowed in the query string.

A command with no address is also a valid command.

The following are the different acceptable formats of the DA command with Instrument Address 5:

```
<STX>DA<CR>
```

```
<STX>DA005<CR>
```

```
<STX>DA<SP><SP>5<ETX><BCC>
```

```
<STX>DA<ETX><BCC>
```

The data query string is valid and will be answered with data transmission only if the command starts with <STX> which is followed by the characters DA, and the <address> (if present) matches the Instrument Address, and the command is terminated with either <CR> with no checksum or <ETX> followed by the correct checksum <BCC>.

Sample Data Reply String in response to Data Query Command (DA):

In response to a valid data query command (DA) the instrument responds in the following format:

```
<STX>MD02<SP><address><SP><measured
value1><SP><status><SP><SFKT><SP><address+1><SP><measured
value2><SP><status><SP><SFKT><ETX><BCC>
```

The response uses the same command terminators as used by the received command i.e. if the received command was terminated with a <CR> the response is terminated with <CR> and if the command was terminated with a <ETX><BCC> the response is terminated with <ETX> and the computed checksum <BCC>.

The 02 after the MD indicates, that two measurements are present in the reply string, (a 03 for three measurements and so on, this will also determine the length of the reply string).

<address> is the Instrument Address. Each subsequent measurement attached to the response will have the <address + X> where X keeps incrementing by 1 for each measurement included.

<measured value> is the concentration value in currently selected gas units represented as exponential representation with 4 characters mantissa and 2 characters exponent, each with sign.

Mantissa: sign and 4 digits. The decimal point is assumed to be after the first digit and is not transmitted.

Exponent: sign and 2 digits.

Example:

-5384000.0 is represented as -5384+06

+0.04567 is represented as +4567-02

<status>: is formed by < operating status > and < error status > and separated by a space i.e.

```
<operating status><SP><error status>
```

Each of the two (<operating status> and <error status>) are formed by two characters each representing a 2 digit hex number which is one byte (8 Bits) operation status and one byte (8 Bits) error status.

These two bytes contain the information about the main operating conditions of the instrument at that instant. For details on how to interpret the status bytes refer to [Table D-1](#) and [Table D-2](#) below.

<SFKT>: is the space provided for future use for special function, it currently contains a string of ten 0's i.e. <0000000000>.

Table D–1. Operating Status for Model 42i

	D7	D6	D5	D4		D3	D2	D1	D0
→ Bit	8	7	6	5		4	3	2	1
→ Hex-value	80	40	20	10		08	04	02	01
	MSB					LSB			
Operating status:									
Service Mode (On)	0	0	0	0		0	0	0	1
Maintenance (Local)	0	0	0	0		0	0	1	0
Zero gas (On)	0	0	0	0		0	1	0	0
Span gas (On)	0	0	0	0		1	0	0	0
Gas Unit Indication (ppm OR ppb)	0	0	0	1		0	0	0	0
Ozonator (Off)	0	0	1	0		0	0	0	0
PMT (Off)	0	1	0	0		0	0	0	0
Not used	1	0	0	0		0	0	0	0

Table D–2. Error Status for Model 42i

	D7	D6	D5	D4		D3	D2	D1	D0
→ Bit	8	7	6	5		4	3	2	1
→ Hex-value	80	40	20	10		08	04	02	01
	MSB					LSB			
Error status:									
Not Used	0	0	0	0		0	0	0	1
Not Used	0	0	0	0		0	0	1	0
Not Used	0	0	0	0		0	1	0	0
Any Temperature Alarm	0	0	0	0		1	0	0	0
Pressure Alarm	0	0	0	1		0	0	0	0
Sample Flow Alarm	0	0	1	0		0	0	0	0
Ozonator Flow Alarm	0	1	0	0		0	0	0	0
Not used	1	0	0	0		0	0	0	0

