



ecotech

environmental monitoring solutions

Serinus 30

Carbon Monoxide

Analyser

User Manual

Version: 3.1

www.ecotech.com

This page is intentionally blank

Table of Contents

Table of Contents.....	3
Manufacturer’s Statement	11
Notice	11
Safety Requirements	12
Warranty.....	12
Service & Repairs	13
CE Mark Declaration of Conformity	14
Claims for Damaged Shipments and Shipping Discrepancies	15
Internationally Recognised Symbols on Ecotech Equipment.....	16
Manual Revision History	17
1. Introduction.....	19
1.1 Description	19
1.2 Specifications	19
1.2.1 Measurement	19
1.2.2 Precision/Accuracy	19
1.2.3 Calibration	20
1.2.4 Power	20
1.2.5 Operating Conditions.....	20
1.2.6 Communications.....	20
1.2.7 Physical Dimensions.....	21
1.2.8 Certifications.....	21
1.3 Nomenclature	21
1.4 Background/Theory.....	23
1.4.1 Measurement Theory	23
1.4.2 Kalman Filter Theory.....	24
1.5 Instrument Description	25
1.5.1 Calibration Valve Manifold	25
1.5.2 Sample Filter Holder	25
1.5.3 CO-CO ₂ Converter	25
1.5.4 Measurement Cell	26
1.5.5 Pressure Sensor PCA	27
1.5.6 Pneumatic Tubing.....	27
1.5.7 Main Controller PCA	27
1.5.8 Power Supply	28
1.5.9 On/Off Switch	28
1.5.10 Communications.....	28
2. Installation.....	31
2.1 Initial Check.....	31
2.2 Installation Notes	32
2.3 Instrument Set-Up.....	33
2.3.1 Pneumatic Connections	33
2.3.2 Power Connections.....	34
2.3.3 Communications Connections	34
2.3.4 Instrument Set-Up	35

2.4	U.S. EPA Reference Set-Up	36
2.5	EN Type Approval Set-Up.....	37
2.6	Transporting/Storage.....	38
3.	Operation.....	41
3.1	Warm-Up	41
3.2	Measurement	41
3.3	General Operation Information	42
3.3.1	Keypad & Display.....	42
3.3.2	Home Screen	44
3.4	Menus & Screens	45
3.4.1	Quick Menu	45
3.4.2	Main Menu	46
3.4.3	Analyser State Menu	46
3.4.4	Status Menu	47
3.4.5	Temperature Menu	48
3.4.6	Pressure & Flow Menu	49
3.4.7	Voltage Menu.....	49
3.4.8	General Settings Menu.....	49
3.4.9	Measurement Settings Menu.....	50
3.4.10	Calibration Menu	51
3.4.11	Pressure Calibration Menu.....	53
3.4.12	Flow Calibration Menu (Option).....	53
3.4.13	Service Menu.....	54
3.4.14	Diagnostics Menu.....	54
3.4.15	Digital Pots Menu	55
3.4.16	Internal Pump Menu (Option).....	56
3.4.17	Valve Menu	56
3.4.18	Tests Menu.....	57
3.4.19	Digital Input Test Menu.....	57
3.4.20	Digital Output Test Menu.....	57
3.4.21	Calculation Factors Menu.....	58
3.4.22	Communications Menu	58
3.4.23	Data Logging Menu	59
3.4.24	Serial Communication Menu.....	59
3.4.25	Analog Input Menu	60
3.4.26	Analog Output Menu.....	60
3.4.27	Digital Input Menu	62
3.4.28	Digital Output Menu	63
3.4.29	Network Menu (Option).....	64
3.4.30	Bluetooth Menu	65
3.4.31	Advanced Menu	65
3.4.32	Hardware Menu	66
3.4.33	Parameter Display Menu.....	66
4.	Communications.....	67
4.1	RS232 Communication.....	67
4.2	USB Communication	68
4.3	TCP/IP Network Communication (optional)	69
4.3.1	Reading Network Port Setup.....	70
4.3.2	Setting Network Port Setup	70

4.3.3	Port Forwarding on Remote Modem/Router Setup	71
4.3.4	Airodis Setup to Communicate with Serinus	72
4.4	Analog and Digital Communication	73
4.4.1	Analog Outputs	73
4.4.2	Analog Inputs	74
4.4.3	Digital Status Inputs	74
4.4.4	Digital Status Outputs	74
4.5	Logging Data	76
4.5.1	Configure Instrument Internal Logging	76
4.6	Using Airodis Software to Download Data	76
4.6.1	Connecting the Instrument to Your PC	76
4.6.2	Installing Airodis	80
4.6.3	Configuring Airodis	80
4.7	Serinus Remote App/Bluetooth	85
4.7.1	Installation	85
4.7.2	Connecting to the Instrument	86
4.7.3	Instrument Control	87
4.7.4	Real-Time Plot.....	88
4.7.5	Download.....	89
4.7.6	Get Parameters.....	90
4.7.7	Preferences.....	91
5.	Calibration	93
5.1	Overview	93
5.2	Pressure Calibration	95
5.2.1	Full Pressure Calibration	95
5.2.2	Ambient Point Pressure Calibration.....	96
5.3	Pressure Calibration (Internal Pump Option Only).....	97
5.4	Manual Background	97
5.5	Zero Calibration.....	98
5.5.1	Calibration Port.....	98
5.5.2	Sample Port	99
5.5.3	Background Air Port.....	99
5.6	Span Calibration	99
5.6.1	Calibration Port.....	100
5.6.2	Sample Port	100
5.6.3	Manual Instrument Gain and Offset Adjustments.....	101
5.7	Precision Check	101
5.8	Multipoint Precision Check	102
5.9	Flow Calibration (Internal Pump Option Only)	103
5.10	High Pressure Zero/Span Valve (Option).....	104
5.10.1	Single Pressurised Calibration Option.....	105
5.10.2	Dual Pressurised Calibration Option.....	107
6.	Service	109
6.1	Maintenance Tools.....	109
6.2	Maintenance Schedule.....	110
6.3	Maintenance Procedures	111
6.3.1	Particulate Filter Replacement	111
6.3.2	Clean Fan Filter	112

6.3.3	DFU Replacement.....	112
6.3.4	Leak Check.....	112
6.3.5	CO-CO ₂ Converter Check.....	115
6.3.6	Sintered Filter/Orifice Replacement	116
6.3.7	Trim Pot Tuning Procedure	117
6.3.8	Clean Pneumatics.....	117
6.3.9	Pressure Sensor Check	117
6.4	Bootloader	119
6.4.1	Display Help Screen	119
6.4.2	Communications Port Test.....	119
6.4.3	Updating Firmware	119
6.4.4	Erase All Settings.....	120
6.4.5	Start Analyser	120
7.	Troubleshooting.....	121
7.1	Flow Fault	124
7.2	Noisy/Unstable Readings.....	125
7.3	Cell Temperature Failure	126
7.4	Mirror Temperature Failure.....	127
7.5	USB Memory Stick Failure.....	128
7.6	Ecotech Service Support Files	129
8.	Optional Extras.....	131
8.1	Dual Sample Filter (PN: E020100).....	131
8.2	Network Port (PN: E020101).....	131
8.2.1	Hardware Setup	132
8.3	Rack Mount Kit (PN: E020116).....	132
8.4	Internal Pump (PN: E020107)	136
8.4.1	Hardware Setup	136
8.4.2	Internal Pump Additional Components.....	136
8.4.3	Internal Pump Removed Components	137
8.4.4	Pressure Calibration Internal Pump Option	137
8.4.5	Flow Calibration	137
8.4.6	Internal Pump Leak Check.....	137
8.4.7	Pump Control	137
8.5	Metric Fittings Kit (PN: E020122).....	138
8.6	High Pressure Zero/Span Valves	138
8.7	Trace Level Instrument (PN: E020127)	138
8.7.1	Trace Specifications.....	138
8.7.2	Measurement.....	139
8.7.3	Precision/Accuracy.....	139
8.7.4	Calibration.....	139
8.7.5	Trace setup.....	139
8.7.6	Trace Operation	140
8.7.7	Trace Default Values	140
8.7.8	Trace Calibration Guidelines	141
8.7.9	Trace Service and Maintenance	141
9.	Parts List and Schematics.....	143
9.1	Serinus Accessories Kit.....	143

9.2	Maintenance Kit	143
9.3	Consumables	144
9.4	Instrument Parts List	144
9.5	Plumbing Schematic – (PN: D020005)	146
9.6	Trace Plumbing Schematic – (PN: D020066)	147
9.7	Block Wiring Schematic – (PN: D020102)	148
9.8	CO Cell Assembly – (PN: H014100)	149
9.9	Source Timing Assembly – (PN: H014125)	150
9.10	Calibration Manifold Assembly – (PN: H010013-01)	151
9.11	Valve Assembly – (PN: H010042)	152
9.12	High Pressure Valve Exploded View – (PN: H050043)	153

List of Figures

Figure 1 – Measurement Cell Theory	23
Figure 2 – Correlation Wheel	24
Figure 3 – Internal Components Diagram	25
Figure 4 – Ecotech Tygon Tubing	27
Figure 5 – Opening the Instrument	31
Figure 6 – Instrument Back Panel	33
Figure 7 – Travel Screw Locations	35
Figure 8 – Installation of USB Memory Stick	38
Figure 9 – Switching the Battery On/Off	39
Figure 10 – Front Panel	42
Figure 11 – Home Screen	44
Figure 12 – Communication Ports	67
Figure 13 – Multidrop RS232 Cable Example	68
Figure 14 – Example of Typical Network Setups	69
Figure 15 – Example of Network Menu Setup	71
Figure 16 – Port Forwarding Example	71
Figure 17 – LAN Network Set-Up (Airodis)	72
Figure 18 – WAN Network Set-Up (Airodis)	72
Figure 19 – 25 Pin Rear Panel PCA (Default Jumpers Highlighted)	75
Figure 20 – External 25 Pin I/O Individual Pin Descriptions	75
Figure 21 – Installing Driver Software (Device Manager)	77
Figure 22 – Update Driver Popup	77
Figure 23 – Update Driver Popup (Directory Location)	78
Figure 24 – Installing Driver Confirmation Prompt	78
Figure 25 – Successful Driver Installation	79
Figure 26 – Airodis Workspace Manager	80
Figure 27 – Adding a New Station	81
Figure 28 – New Station Connection	81
Figure 29 – Station Configuration (Channel List)	82
Figure 30 – Error Status Notification	82

Figure 31 – Downloading Data	83
Figure 32 – Download Data Status	83
Figure 33 – Data Visibility	84
Figure 34 – Exporting Data	84
Figure 35 – Data Download Complete.....	85
Figure 36 – Downloading the App From Google Play Store	86
Figure 37 – Bluetooth Pairing Request.....	86
Figure 38 – Showing or Hiding the NumPad.....	87
Figure 39 – Switching Analysers	88
Figure 40 – Real-Time Plot.....	89
Figure 41 – Plot of Downloaded Data.....	90
Figure 42 – Directory Settings	91
Figure 43 – Logs Format	91
Figure 44 – Colour Theme Settings.....	92
Figure 45 – Example of a Calibration System	93
Figure 46 – Excel Graph of Multipoint Precision Check.....	103
Figure 47 – Single High Pressure Calibration Option.....	105
Figure 48 – Dual High Pressure Calibration Option	107
Figure 49 – Minifit Extraction Tool – (PN: T030001)	109
Figure 50 – Orifice/Sintered Filter Removal Tool – (PN: H010046).....	109
Figure 51 – Leak Test Jig – (PN: H050069).....	110
Figure 52 – Air Monitoring Test Equipment Kit (AMTEK) – Customisable	110
Figure 53 – Removing the Plunger	111
Figure 54 – Removing the Fan Filter.....	112
Figure 55 – DFU Filter	112
Figure 56 – Leak Test Jig on Exhaust	113
Figure 57 – Kynar Fitting Containing Orifice and Sintered Filter	116
Figure 58 – Test Point Location	118
Figure 59 – Flow Fault Diagnostic Procedure	124
Figure 60 – Noisy Zero or Unstable Span Diagnostic Procedure	125
Figure 61 – Cell Temperature Failure Diagnostic Procedure.....	126
Figure 62 – Mirror Temperature Failure Diagnostic Procedure	127
Figure 63 – USB Memory Stick Failure	128
Figure 64 – USB Memory Stick File Structure.....	130
Figure 65 – Dual Filter Option Installed.....	131
Figure 66 – Separate Rack Slides	133
Figure 67 – Assemble Inner Slide on Chassis.....	133
Figure 68 – Rack Mount Ears Fitted to Instrument	134
Figure 69 – Attach Rack Mount Adaptors to Outer Slides.....	134
Figure 70 – Test Fit the Rack Slide Assembly into the Rack.....	135
Figure 71 – Attach Slides to Front of Rack.....	135
Figure 72 – Slide Clips.....	136

List of Tables

Table 1 – Manual Revision History	17
Table 2 – Measurements: Background and Sample Cycles.....	41
Table 3 – Digital Output States	63
Table 4 – Analog Outputs	73
Table 5 – New Station Setup	81
Table 6 – Maintenance schedule	110
Table 7 – Troubleshoot List	121
Table 8 – Included Parts (Rack Mount Kit)	132
Table 9 – Internal Pump Additional Components	137
Table 10 – Internal Pump Removed Components	137
Table 11 – Trace Parts Removed.....	138
Table 12 – Trace Parts Added.....	139
Table 13 – Trace Parameter Value Changes.....	140
Table 14 – Maintenance Schedule	141
Table 15 – Serinus Accessories Kit – (PN: H010136)	143
Table 16 – Serinus 30 Maintenance Kit – (PN: E020202)	143
Table 17 – Serinus 30 Consumables.....	144
Table 18 – Spare Parts List Serinus 30.....	144
Table 19 – Packet Format.....	155
Table 20 – Example: Primary Gas Request.....	155
Table 21 – Example: Primary Gas Response	156
Table 22 – Example: Primary Gas Response (continued).....	156
Table 23 – List of Errors.....	156
Table 24 – Example: Get IEEE Response data	157
Table 25 – Advanced Protocol Parameter List	158
Table 26 – Bayern-Hessen Data	171
Table 27 – Block Check Operation	172
Table 28 – Status Bit Map	173
Table 29 – Failure Bit Map (Positive Logic)	173
Table 30 – Modbus Error Codes.....	177

List of Appendices

Appendix A. Advanced Protocol.....	155
A.1 Command Format	155
A.2 Commands	156
A.3 List of Parameters.....	158
Appendix B. EC9800 Protocol	169
B.1 Command Format	169
B.2 Commands	169
Appendix C. Bayern-Hessen Protocol	171
C.1 Command Format	171

C.2	Commands	172
Appendix D. ModBus Protocol		175
D.1	Command Format	175
D.2	Commands	176

Manufacturer's Statement

Thank you for selecting the Ecotech Serinus 30 Carbon Monoxide Analyser.

The Serinus series is the next generation of Ecotech designed and manufactured gas analysers. The Serinus 30 will perform CO measurements over a range of 0-200 ppm with a lower detectable limit of 40 ppb.

This User Manual provides a complete product description including operating instructions, calibration and maintenance requirements for the Serinus 30 Carbon Monoxide Analyser. This manual is valid for the most recent version of the Serinus 30 which includes the new Autoranging Power Supply, Main Controller PCA and Rear Panel PCA.

Reference should also be made to the relevant local standards which should be used in conjunction with this manual. Some of these standards are listed in this manual.

If, after reading this manual you have any questions or you are still unsure or unclear on any part of the Serinus 30, please do not hesitate to contact Ecotech or your local Ecotech distributor.



Please help the environment and recycle the pages of this manual when you have finished using it.

Notice

The information contained in this manual is subject to change without notice. Ecotech reserves the right to make changes to equipment construction, design, specifications and/or procedures without notification.

Copyright © 2014. All rights reserved. Reproduction of this manual, in any form, is prohibited without the written consent of Ecotech Pty Ltd.



CAUTION

Hazardous voltages exist within the instrument. Do not remove or modify any of the internal components or electrical connections whilst the mains power is on.

Ensure the mains power lead is maintained in a safe working condition.

The instruments lid should be closed during normal operation to comply with EMC regulations.

Safety Requirements

To reduce the risk of personal injury caused by electrical shock, follow all safety notices and warnings in this documentation.

If the equipment is used for purposes not specified by Ecotech, the protection provided by this equipment may be impaired.

Replacement of any part should only be carried out by qualified personnel, using only parts specified by Ecotech as these parts meet stringent Ecotech quality assurance standards. Always disconnect the power source before removing or replacing any components.

Warranty

This product has been manufactured in an ISO 9001/ISO 14001 facility with care and attention to quality.

The product is subject to a 24-month warranty on parts and labour from date of shipment. The warranty period commences when the product is shipped from the factory. Lamps, filters and other consumable items are not covered by this warranty.

Each instrument is subjected to a vigorous testing procedure prior to despatch and will be accompanied with a parameter list and a multipoint precision check, thereby enabling the instrument to be installed and ready for use without any further testing.

Service & Repairs

Our qualified and experienced technicians are available to provide fast and friendly service between the hours of 8:30am – 5:00pm AEST Monday to Friday. Please contact either your local distributor or Ecotech regarding any questions you have about your instrument.

Service Guidelines

This manual is designed to provide the necessary information for the setup, operation, testing, maintenance and troubleshooting of your instrument.

Should you still require support after consulting the documentation, we encourage you to contact your local distributor for support.

To contact Ecotech directly, please e-mail our Technical Support Services group at support@ecotech.com or to speak with someone directly:

Please dial 1300 364 946 if calling from within Australia.

Please dial +61 3 9730 7800 if calling from outside of Australia.

Please contact Ecotech and obtain a Return Material Authorisation (RMA) number before sending any equipment back to the factory. This allows us to track and schedule service work and to expedite customer service. Please include this RMA number when you return equipment, preferably both inside and outside the shipping packaging. This will ensure you receive prompt service.

When shipping instrumentation, please also include the following information:

- Name and phone number
- Company name
- Shipping address
- Quantity of items being returned
- Model number/s or a description of each item
- Serial number/s of each item (if applicable)
- A description of the problem and any fault-finding completed
- Original sales order or invoice number related to the equipment

Shipping Address:

Attention Service Department

Ecotech Pty Ltd

1492 Ferntree Gully Road,

Knoxfield, VIC, Australia 3180.

CE Mark Declaration of Conformity

This declaration applies to the Serinus 30 Carbon Monoxide Analyser as manufactured by Ecotech Pty Ltd of 1492 Ferntree Gully Rd, Knoxfield, VIC, Australia 3180. The instrument to which this declaration relates is in conformity with the following European Union Directives:

Council Directive of 15 December 2004 on the approximation of the laws of Member States relating to electromagnetic compatibility (2004/108/EC)

The following standard was applied:

EN 61326-1:2013 Electrical equipment for measurement, control and laboratory use – EMC requirements – Part 1: General requirements

Immunity Requirements EN 61326-1

IEC-61000-4-2 Electrostatic discharge immunity
IEC-61000-4-3 Radiated RF immunity
IEC-61000-4-4 Electrical fast transient burst immunity
IEC-61000-4-5 Surge immunity
IEC-61000-4-6 Conducted RF immunity
IEC-61000-4-11 Voltage dips and interruption immunity

Electromagnetic Compatibility EN 61326-1

CISPR-11 Radiated RF emission measurements
CISPR-11 Mains terminal RF emission measurements
IEC-61000-3-3 Mains terminal voltage fluctuation measurements
IEC-61000-3-2 Power frequency harmonic measurements

Council Directive of 12 December 2006 on the harmonisation of the laws of Member States relating to electrical equipment designed for use within certain voltage limits (2006/95/EC)

The following standard was applied:

EN 61010-1:2013 Safety requirements for electrical equipment, for measurement control and laboratory use (**3rd edition**) – Part 1: General requirements

For protection against:

- Electric shock or burn
- Mechanical Hazards
- Excessive temperature
- Spread of fire from the equipment
- Effects of fluids and fluid pressure
- Effects of radiation, including laser sources, sonic and ultrasonic pressure
- Liberated gases, explosion and implosion

Claims for Damaged Shipments and Shipping Discrepancies

Damaged Shipments

Inspect all instruments thoroughly on receipt. Check materials in the container/s against the enclosed packing list. If the contents are damaged and/or the instrument fails to operate properly, notify the carrier and Ecotech immediately.

The following documents are necessary to support claims:

- Original freight bill and bill of lading
- Original invoice or photocopy of original invoice
- Copy of packing list
- Photographs of damaged equipment and container

You may want to keep a copy of these documents for your records.

Please refer to the instrument name, model number, serial number, sales order number and your purchase order number on all claims.

You should also:

- Contact your freight forwarder for an insurance claim
- Retain packing material for insurance inspection

Shipping Discrepancies

Check all packages against the packing list immediately on receipt. If a shortage or other discrepancy is found, notify the carrier and Ecotech immediately. Ecotech will not be responsible for shortages against the packing list unless they are reported within seven days.

Contact Details

Head Office

1492 Ferntree Gully Road, Knoxfield, VIC Australia 3180

Phone: +61 (0)3 9730 7800 Fax: +61 (0)3 9730 7899





Email: info@ecotech.com

Service: service@ecotech.com

Support: support@ecotech.com

www.ecotech.com

Internationally Recognised Symbols on Ecotech Equipment

	Protective conductor terminal	IEC 60417-5017
	Alternating current	IEC 60417-5032
	Caution, hot surface	IEC 60417-5041
	Caution, risk of danger. Refer to accompanying documents	ISO 7000-0434
	Caution, risk of electric shock	ISO 3864-5036

Manual Revision History

Manual PN: M010027
 Current revision: 3.1
 Date released: 20 April 2016
 Description: User Manual for the Serinus 30 Carbon Monoxide Analyser

This manual is the full user manual for the Serinus 30 Carbon Monoxide Analyser. This manual contains all relevant information on theory, specifications, installation, operation, maintenance and calibration. Any information that cannot be found within this manual can be obtained by contacting Ecotech.

This manual uses cross reference links extensively throughout this manual. The hot keys below will greatly reduce the amount of time scrolling between references:

- You can access the links by pressing the following:
 - > CTRL + LEFT MOUSE CLICK: Move to the link location

- You can switch between links by pressing the following:
 - > ALT + LEFT ARROW KEY: Returns you to previous Link
 - > ALT + RIGHT ARROW KEY: Swaps back

Table 1 – Manual Revision History

Edition	Date	Summary
1.0	October 2008	Initial release
1.1	February 2009	Updated communications
1.2	February 2009	New maintenance procedures Updated instrument set-up Small corrections
1.3	November 2009	Updates to menu system Serinus downloader software Internal pump option Advanced parameter list
1.4	September 2010	CE conformity added Updated parts list Pressurised zero/span valve added Updates to rack mount option Updates to Serinus downloader Update to 25 pin I/O Update to network communication

Edition	Date	Summary
		Analog inputs Network adapter menu
2.0	July 2012	New chassis Update menu system Add Bluetooth menu Serinus Remote Android App Rack mount procedure update Analog output calibration
2.1	March 2013	Update of manual drawings, pictures and content. Format updated.
2.2	November 2013	Formatting updates Addition of Airodis installation steps
3.0	December 2014	Auto-Ranging Power Supply added Main Controller and Rear Panel PCAs changed.
3.1	April 2016	Trace option section

1. Introduction

1.1 Description

The Ecotech Serinus 30 Carbon Monoxide Analyser uses Non-Dispersive Infrared Spectrophotometry (NDIR) technology to measure CO in ambient air, in the range of 0-200 ppm.

The U.S. EPA has designated the Serinus 30 Carbon Monoxide Analyser as a reference method and TUV has designated it as an EN approved instrument.

This section will describe the specifications of the instrument as well as the main components and techniques used to obtain stable gas concentration readings.

1.2 Specifications

1.2.1 Measurement

Range

0-200 ppm autoranging

USEPA designated range: Any full scale range between 0-50 ppm

TUV EN certification range: 0-100 ppm

Lower detectable limit: 0.04 ppm (40 ppb), with Kalman filter active

1.2.2 Precision/Accuracy

Precision

20 ppb or 0.1 % of reading, whichever is greater

Linearity

Better than ± 1 % of full scale (0-50 ppm); ± 2 % of full scale (0-200 ppm), from best straight-line fit

Noise at Zero

0.02 ppm

Response Time

60 seconds to 95 %

Sample Flow Rate

1.0 slpm

1.2.3 Calibration

Zero Drift

Temperature dependant:	0.01 ppm per °C
24 hours:	< 0.1 ppm
30 days:	< 0.1 ppm

Span Drift

Temperature dependant:	0.05 % per °C
24 hours:	0.5 % of reading
30 days:	0.5 % of reading

1.2.4 Power

Operating voltage

100-240 VAC, 50 to 60 Hz (autoranging)

Power Consumption

260 VA max (typical at start up)

150 VA after warm-up

1.2.5 Operating Conditions

Ambient Temperature Range

0 °C to 40 °C (32 °F to 104 °F)

U.S. EPA designated range: 20 °C to 30 °C

Sample Pressure Dependence

5 % change in pressure produces less than a 1 % change in reading

Maximum altitude: 3000 m above sea level

1.2.6 Communications

Analog Output

- Menu selectable current output of 0-20 mA, 2-20 mA or 4-20 mA.
- Voltage output of 0 to 5 V, with menu selectable zero offset of 0 V, 0.25 V or 0.5 V.
- Voltage output of 0 to 10 V (configured using jumpers (JP3) on rear panel PCA).
- Range: 0 to full scale from 0-0.05 ppm to 0-20 ppm.

Analog Input

- Three analog voltage inputs (0-5 VDC) CAT I rated.

Digital Output

- RS232 port #1: Normal digital communication.
- RS232 port #2: Multidrop port used for multiple instrument connections on a single RS232.
- USB port connection on rear panel.
- TCP/IP port (optional)
- USB memory stick (front panel) for data logging, event logging, parameter and configuration storage.
- 25 pin connector with discrete status and user control.
 - o Eight Digital Outputs, open collector max 400 mA each @ 12 VDC (max total output 2 A).
 - o Eight Digital Inputs, 0-5 VDC, CAT I rated

1.2.7 Physical Dimensions

Case Dimensions

Rack length (front to rear):	597 mm (23.5")
Total length (with latch release):	638 mm (25.1")
Chassis width:	418 mm (16.5")
Front panel width:	429 mm (16.9")
Chassis height:	163 mm/Uses 4 RU (6.4")
Front panel height:	175 mm (6.9")
Weight:	17.8 kg

1.2.8 Certifications

- U.S. EPA approved (RFCA-0509-174)
- EN approval (TUV 936/21221977/D)
- Non Dispersive I.R. Spectrometry method EN1426
- Determination of carbon monoxide AS 3580.7.1.2011 Australian/New Zealand standards

1.3 Nomenclature

CO:	Carbon monoxide.
Span:	A gas sample of known composition and concentration used to calibrate/check the upper range of the instrument (carbon monoxide).
Zero:	Zero calibration uses zero air (CO scrubbed ambient air) to calibrate/check the lower range of the instrument.

Background:	Draws air from the background port to compensate for changes in the IR source and background interferences.
Multipoint Precision Check:	A procedure to verify the linearity of the instrument.
Calibration:	The process of adjusting the instrument to ensure that it is measuring the correct concentration.
Zero Drift:	The change in the instruments response to zero air over a period of continuous unadjusted operation.
Automatic Zero:	The automatic zero performs a zero check at a specified time through a 24 hour cycle which adjusts the lower limit of the instrument.
Zero Air:	Is purified air in which the concentration of CO is <50 ppb with water vapour of less than 10 % RH. The internal CO-CO ₂ catalytic converter uses platinum impregnated alumina beads heated to 90 °C as a conversion agent to achieve this under ambient conditions.
External Span Source:	Span gas that is delivered via an external accredited cylinder (e.g. NATA/NIST).
Sample Air:	Sample air is defined as the sample before it has entered the Measurement cell, as distinguished from the exhaust air.
Exhaust Air:	Exhaust air is the sample air after it has passed through the reaction/measurement/detection cell and is moving towards being expelled from the instrument.
ID and OD:	These are measurements of tubing. ID is the internal diameter of tubing, OD is the outer diameter.
Multidrop:	A configuration of multiple instruments connected via the same RS232 cable.
Bootloader:	A program that checks whether the current firmware is valid and executes the instrument start-up. The Bootloader can be entered by pressing the '+' key on the front keypad during the first ½ second after power on and following the prompts. The Bootloader enables various low level recovery tools, including updating the firmware from a USB stick.
PCA:	Printed Circuit Assembly. An electronic circuit mounted on a printed circuit board to perform a specific electronic function.
IR:	Infrared. The region of the optical spectrum with a wavelength of around 4.7 microns.
slpm:	Standard litres per minute. This is the flow referenced to standard temperature and pressure conditions. For the purposes of this manual, all flows are referenced to 0 °C and 101.3 kpa (1 atm).

1.4 Background/Theory

Carbon monoxide poisoning is the most common type of fatal poisoning in many industrialised countries¹. Carbon monoxide is a colourless, odourless and tasteless gas caused by the incomplete combustion of hydrocarbon fuels.

Carbon monoxide is a toxic gas to the human body, when inhaled it binds to haemoglobin, myoglobin and mitochondrial cytochrome oxidase reducing oxygen storage, transport and respiration in these organelles.

This can affect humans by causing low level symptoms such as headaches, nausea and dizziness leading up to vomiting and loss of mental/muscular control at high exposure and death in extreme cases.

1.4.1 Measurement Theory

The measurement of carbon monoxide is completed via the following principles and measurement techniques:

CO absorbs infrared radiation (IR) at a wavelength near 4.7 microns. IR radiation (at 4.7 microns) is passed through a five metre folded path length through sample air. The strength of the signal received is proportional to the amount of CO in the sample. A band pass filter is fitted to the signal detector to ensure only light near 4.7 microns wavelength is detected.

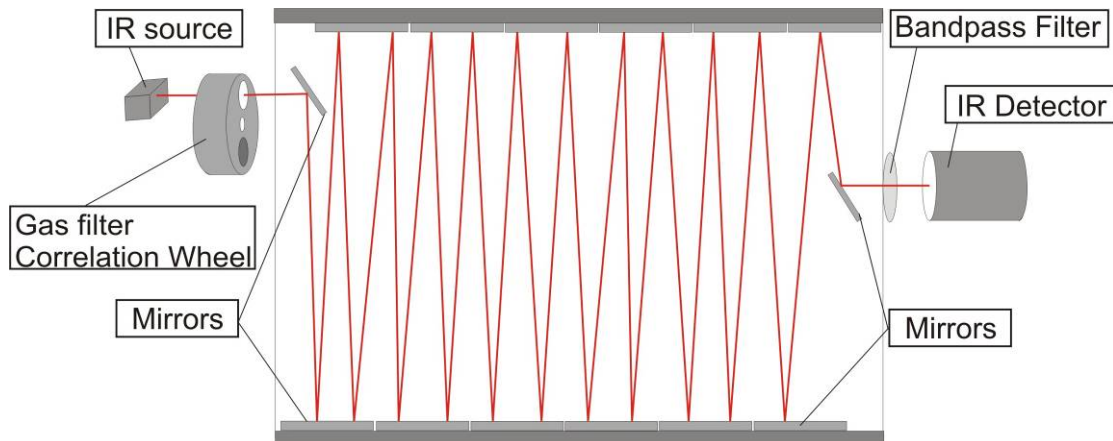

Figure 1 – Measurement Cell Theory

A gas filter correlation wheel is combined with this system. This wheel contains three parts to increase measurement accuracy: CO, N₂ and the mask.

¹ Toxicology. 2002 Nov 15;180(2):139-50

- The CO window contains saturation (40 %) of CO which acts as a reference beam – absorbing a known amount of light.
- The N₂ window, containing 100 % N₂, does not absorb IR at 4.7 microns at all and is used during normal CO measurement.
- The mask totally blocks the light source and is used to determine background signals, the strength of other signals relative to each other and the background.

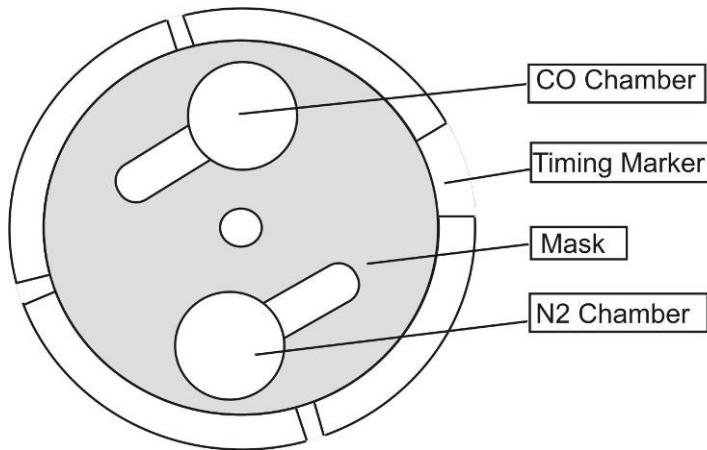

Figure 2 – Correlation Wheel

1.4.2 Kalman Filter Theory

The digital Kalman filter provides an ideal compromise between response time and noise reduction for the type of signal and noise present in ambient air analysers.

The Kalman filter enhances measurements by modifying the filter time base variable, depending on the change rate of the measured value. If the signal is changing rapidly, the instrument is allowed to respond quickly. When the signal is steady, a long integration time is used to reduce noise. The system continuously analyses the signal and uses the appropriate filtering time.

1.5 Instrument Description

The major components of the Serinus 30 are described below:

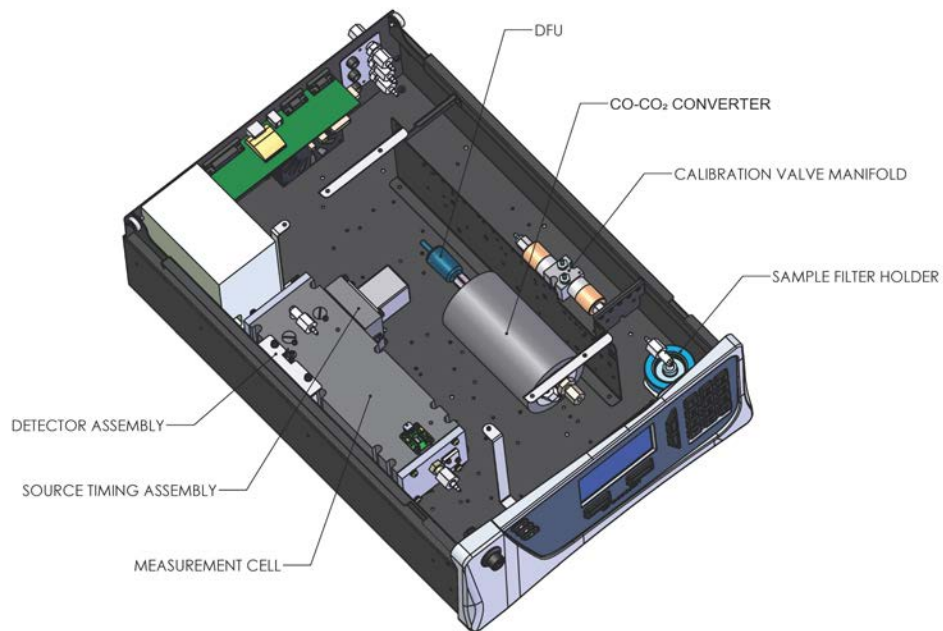

Figure 3 – Internal Components Diagram

1.5.1 Calibration Valve Manifold

The calibration valve manifold switches between sample, calibration and background gas.

1.5.2 Sample Filter Holder

Within the sample filter holder is a particulate filter. The particulate filter is a Teflon 5 micron (μm) filter with a diameter of 47 mm. This filter prevents all particles larger than 5 μm from entering the measurement system that could interfere with sample measurement.

1.5.3 CO-CO₂ Converter

The CO-CO₂ catalytic converter uses platinum impregnated alumina beads heated to 90 °C as a conversion agent. The catalyst achieves conversion of 0-200 ppm CO to less than 0.1 ppm CO, even in the presence of up to 2% water.

Within the body of the CO-CO₂ converter assembly, there is a heat exchanger used to precondition the sample gas up to temperature. The sample gas is then drawn into the measurement cell.

1.5.4 Measurement Cell

The measurement cell consists of the following components:

Cell	Refer to Section 1.5.4.1.
Source Timing Assembly	Refer to Section 1.5.4.2.
Detector Assembly	Refer to Section 1.5.4.3.

1.5.4.1 Cell

Cell

The measurement cell contains five mirrors that form a five meter folded path length through the cell. The sample gas fills this chamber and the IR light travels through the sample. The cell pressure is monitored to compensate for pressure changes.

1.5.4.2 Source Timing Assembly

The source timing assembly consists of the following:

IR Source

The IR source emits broadband infrared radiation that irradiates the filter in the correlation wheel.

Gas Filter Correlation Wheel

The gas filter correlation wheel contains three segments: a N₂ filled sapphire chamber, a CO filled sapphire chamber and a mask.

- The N₂ chamber allows all the IR radiation to pass through, which allows the radiation to be absorbed by CO in the measurement cell and readings to be recorded.
- The CO filled chamber absorbs wavelengths sensitive to CO. The sample gas (containing CO) in the measurement cell does not receive CO specific IR radiation and the only detected signals registered by the IR detector are from background sources and interference.
- The mask blocks all IR light entering the cell. This allows the intensity of the other two signals to be corrected for the detector response to no IR.

Opto-Detector

The correlation wheel has four tabs that act as an opto electronic switch ensuring that the main controller PCA can determine accurate timing of the wheel and the segment currently exposed to the IR radiation.

Motor

The motor that drives the correlation wheel is a 12 V precious metal brushed motor.

1.5.4.3 Detector Assembly

The detector assembly consists of the following:

Narrow-Bandpass Filter

The narrow bandpass filter allows only the CO sensitive portion of the IR radiation to pass through to the IR detector (4.7 microns) reducing noise and interference.

IR Detector

The IR detector is a cooled lead selenide (PbSe) photoconductive IR detector. It creates an electrical signal when wavelengths centred at 4.7 microns reach it.

1.5.5 Pressure Sensor PCA

An absolute-pressure transducer is mounted on the measurement cell and used to measure the sample pressure in the cell. This pressure is used to check for flow and correct readings for pressure variations.

1.5.6 Pneumatic Tubing

The pneumatic tubing inside this instrument is specially designed for use in Ecotech Serinus instruments. It has the flexibility of Tygon tubing with the added inner sheath of Teflon to prevent contamination of the sample. Care should be taken when removing and inserting the tubing into the barbed fittings.



Figure 4 – Ecotech Tygon Tubing

1.5.7 Main Controller PCA

The main controller PCA controls all the processes within the instrument. As well as the on-board microprocessor, it contains a battery backed clock, calendar analog to digital converters and many other circuits for signal processing and control. The ambient pressure and chassis temperature sensors are also located on this board. The main controller PCA is located above all other components within the instrument. It pivots on hinges to allow access to the components underneath. The current revision of the main controller PCA for which this manual applies, has many differences to previous revisions, highlighted by the many vacant component locations on the PCA.



CAUTION

Never place objects on top of the main controller PCA as it may result in damage.

1.5.8 Power Supply

The power supply is a self-contained unit housed in a steel case designed to meet all the relevant safety and EMC requirements. The new revision of power supply is different to the previous revision as there is no need to set the operating voltage switch because it is autoranging.

The output of the power supply provides +12 V, +5 V, -12 V and +3.3 V to the instrument.

1.5.9 On/Off Switch

The on/off switch is located on the back panel (bottom right facing the rear of the instrument). It is part of the power supply.

1.5.10 Communications

Communication between the instrument and either a data logger, laptop or network can be performed with the following communication connections located on the back panel (refer to Figure 6). These connections can be used for downloading data, onsite diagnostics, maintenance and firmware upgrades.

RS232 #1

This port is designed to be used for simple RS232 communication.

RS232 #2

This port is designed to be used for simple RS232 communication or in multidrop configuration.

USB

This port can be used for instrument communications with equipment through a standard USB port.

TCP/IP Network (optional)

This port is best used for remote access and real-time access to instruments when a network is available to connect with.

Analog and Digital I/O

The analog/digital port sends and receives analog/digital signals to other devices. These signals are commonly used to activate gas calibrators or for warning alarms.

Analog Outputs

The instrument is equipped with a maximum of three analog outputs for each measured gas. The outputs are menu selectable as voltage output 0-5 VDC, or current output 0-20, 2-20 or 4-20 mA. The current output can also be configured as a voltage output of 0 to 10 V, by configuring the jumpers (JP3) on the rear panel PCA.

Refer to Section 4.4 for more detail.

Analog Inputs

The instrument is also equipped with three analog voltage inputs (0-5 VDC CAT 1) with resolution of 15 bits plus polarity.



CAUTION

Exceeding these voltages can permanently damage the instrument and void the warranty.

Digital Status Inputs

The instrument is equipped with eight logic level inputs (0–5 VDC CAT 1) for the external control of zero/span calibration sequences.



CAUTION

Exceeding these voltages can permanently damage the instrument and void the warranty.

Digital Status Outputs

The instrument is equipped with eight open collector outputs, which will convey instrument status conditions and warning alarms such as no flow, sample mode, etc.



CAUTION

Exceeding 12VDC or drawing greater than 400mA on a single output or a total greater than 2A across the eight outputs can permanently damage the instrument and void the warranty.

Bluetooth

This allows for remote access of the instrument to any Android device with the Serinus Remote Application installed on it. It uses Bluetooth to control the instrument, view parameters, download data and construct real-time graphs.

This page is intentionally blank

2. Installation

2.1 Initial Check

Packaging

The Serinus 30 is transported in packaging specifically designed to minimise the effects of shock and vibration during transportation. Ecotech recommends that the packaging be kept if there is a likelihood that the instrument is going to be relocated.

Note: The red plastic caps that seal the pneumatic connections during transport must be removed prior to operation.

Opening the Instrument

Check the interior of the instrument with the following steps:

1. Undo the screws located on the rear panel.
2. Open the chassis lid by releasing the latch (pressing the button) located on the front panel in the top left-hand corner, slide the lid backwards.
3. To completely remove; slide the lid backwards until the rollers line up with the gaps in the track and pull the lid upwards to remove from the instrument (refer to Figure 5).
4. Check that all pneumatic and electrical connectors are connected. If not, reconnect.
5. Check for any visible and obvious damage. If damage exists contact your supplier and follow the instructions in Claims for Damaged Shipments and Shipping Discrepancies at the front of this manual.

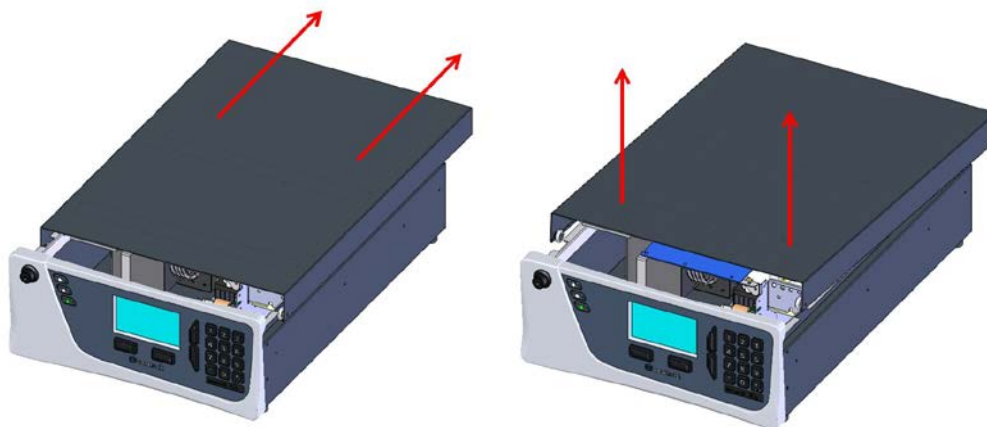

Figure 5 – Opening the Instrument

Items Received

With the delivery of the Serinus 30, the user should have received the following:

- | | | |
|-------------------------------------|-----------|---------------------------------|
| • Ecotech Serinus 30 Analyser | | PN: E020030 |
| • Green Ecotech Resources USB Stick | | PN: H030137-01 |
| • End Caps | | PN: B010002 |
| • Manual | | PN: M010027 (hardcopy optional) |
| • USB Memory Stick | | PN: H030021 |
| • USB Cable | | PN: COM-1440 |
| • Power Lead (120 V)* | USA | PN: C040007 |
| • Power Lead (240 V)* | Australia | PN: C040009 |
| | Europe | PN: C040008 |
| | UK | PN: C040010 |

*The power lead received depends on the mains supply of the country (120 V or 240 V).

Note: Check that all these items have been delivered undamaged. If any item appears damaged, please contact your supplier before turning the instrument on.

2.2 Installation Notes

When installing the instrument the following points must be taken into account:

- The instrument should be placed in an environment with minimal dust, moisture and variation in temperature (20-30 °C for U.S. EPA designated range).
- For best results the instrument should be located in a temperature and humidity controlled environment (air conditioned shelter). An enclosure temperature of 25-27 °C is optimum.
- Whether in a rack or placed on a bench, the instrument should not have anything placed on top of it or touching the case.
- Instruments should be sited with easy access to the front panel (instrument screen/USB memory stick) and to the back panel (communication ports/pneumatic connections).
- It is recommended that the sample line be as short as possible and/or a heated manifold be used for sampling (minimising moisture condensation in the sample).
- Do not pressurise the sample line under any circumstances. Sample should be drawn through the instrument under atmospheric pressure. This should be achieved by either using the internal pump option (if installed) or an external vacuum pump connected to the exhaust port of the instrument.
- When supplying span gas, ensure the flow is approximately 1.5 slpm and excess is sufficiently vented.
- Undo the travel screws from the measurement cell as shown in the drawing supplied (refer to Section 2.3.4).

Note: The power on/off switch is accessible from the rear of the instrument only. Install the instrument so that the on/off power switch is accessible.

2.3 Instrument Set-Up

After installing the instrument the following procedures should be followed to ready the instrument for monitoring:

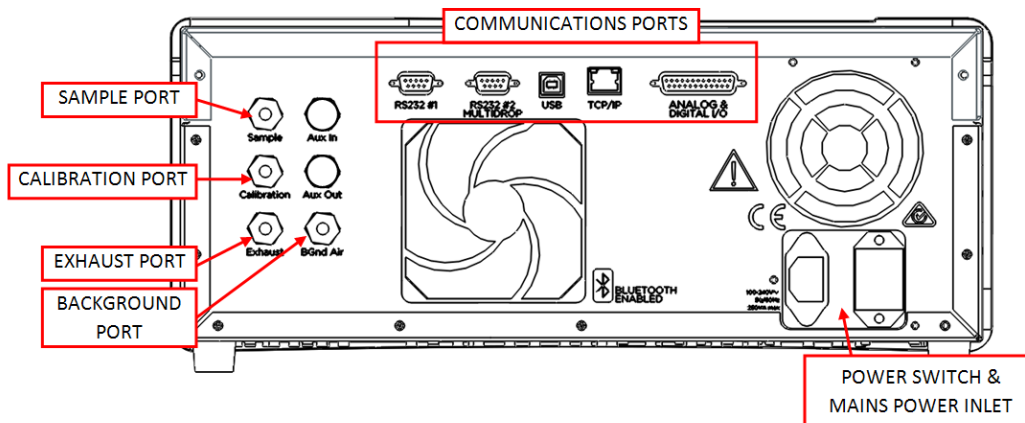

Figure 6 – Instrument Back Panel

2.3.1 Pneumatic Connections

The Serinus 30 has four pneumatic ports on the back panel of the instrument: the Sample Port, the Calibration Port, the Exhaust Port and the Background Air Port. All tubing and fittings used should follow the instructions below:

- Must be made of Teflon® FEP material, Kynar®, stainless steel, glass or any other suitably inert material.
- Sample line should be no more than two meters in length with 1/8 inch ID and 1/4 inch OD.
- Sample inlet pressure should not exceed 5 kPa above ambient pressure.
- Tubing must be cut squarely and any burrs removed.
- Remove the inlet port nut and insert the tubing through the back of the nut with the tube extending one inch through the front.
- Place the tubing into the port until it hits the tube stop located inside the fitting.
- Place the nut back onto the fitting and tighten clockwise until finger tight.
- Nuts should be re-tightened when instrument reaches operating temperature.

Sample Port

The sample port must be connected to an ambient source of sample air. When using a sample manifold the Serinus requires at least 1.5 slpm delivered to the sample manifold (1 slpm for measurement plus approximately 50 % excess).

Calibration Port

The calibration port can be connected to the span/zero sources. It is recommended that a gas dilution calibrator (Ecotech's Serinus Cal 1000) be used with a cylinder of carbon monoxide (CO) to deliver precise concentrations of CO.

Note: All connections to this port should not exceed ambient pressure. A vent is required for excess gas.

Exhaust Port

The exhaust port is where the measured sample, calibration gases and background air are exhausted from the instrument. The exhaust port should be connected to the vacuum pump using ¼" OD tubing. The P030004 240 V vacuum pump (P030005 110 V) available from Ecotech, can be used to provide the required vacuum and flow for one Serinus 30 analyser as well as two other instrument such as a Serinus 10 or Serinus 50.



CAUTION

Carbon monoxide (CO) is a toxic gas. It is recommended that exhaust air is expelled into an unoccupied area, as it contains trace levels of carbon monoxide. Furthermore, the exhaust must be a suitable distance from the sample inlet to avoid influencing the ambient measurements.

Background Air Port

The background port is used to supply air to the CO to CO₂ converter (CO scrubber) within the instrument. This is used for backgrounds and internal zero calibration.

2.3.2 Power Connections



CAUTION

When connecting the mains power to the instrument, the following must be adhered to otherwise the safety and the reliability of the instrument may be compromised.

- A three pin mains power lead with a protective earth conductor **MUST** be used.
- The mains power outlet (wall socket) must be in the range of 100-240 VAC, 50 to 60 Hz.
- The mains power outlet must be protected by an earth leakage protection circuit.
- Connect the instruments power lead into the mains power outlet and turn the power switch on.

2.3.3 Communications Connections

There are a number of ways to communicate with the instrument. Use the supplied Airodis software to access the instrument and download data. The Airodis software is supplied on the green Ecotech resources USB stick provided with this instrument.

RS232 #1

Connect this port to a data logger (such as WinAQMS) with an RS232 cable.

RS232 #2

Connect the RS232 cable from the instrument to a computer or data logger in a multidrop formation.

Note: When using multidrop ensure each instrument is given a unique **Serial ID**.

USB

Connect a standard type B USB cable (supplied with the instrument) to this port.

TCP/IP Network (optional)

Plug in an ethernet cable (this cable should be attached to a network).

Analog and Digital I/O

This port is used to send and receive analog and digital signals. It is normally used to connect with a gas calibrator or to activate alarm signals.

Each instrument contains eight digital inputs, eight digital outputs, three analog inputs and three analog outputs.

Bluetooth

Connection is enabled using Ecotech's Serinus Remote Android Application.

Use the Serinus Remote Android Application to access instrument and download data. It is available for download directly from the Google Play Store. Search for "Ecotech Serinus Remote".

2.3.4 Instrument Set-Up

1. Open the lid and ensure that the USB memory stick is installed (refer to Figure 8).
2. Remove the travel screws from the measurement cell.

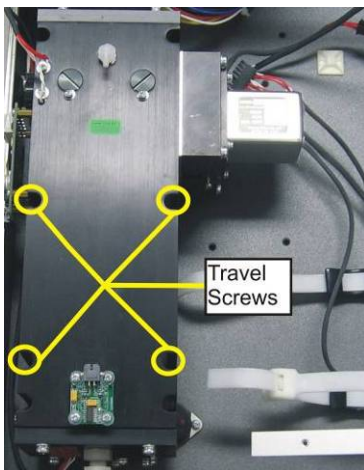

Figure 7 – Travel Screw Locations

3. Check that the battery is turned on at the main controller PCA (refer to Figure 9).
4. Turn on the instrument and allow the warm-up procedure to complete (refer to Section 3.1).
5. Set time and date (refer to Section 3.4.8).
6. Set the digital filter to desired setting (refer to Section 3.4.9).
7. Set the internal data logging options (refer to Section 3.4.23).
8. Set the analog and digital inputs and outputs settings (refer to Section 3.4.25, 3.4.26, 3.4.27 and 3.4.28).
9. Perform a pressure sensor check (refer to Section 6.3.9).
10. Perform a leak check (refer to Section 6.3.4).
11. Leave the instrument to warm-up for at least three hours. Wait for a stable concentration measurement for at least one hour.
12. Perform a manual background (refer to Section 5.4).
13. Perform a span calibration (refer to Section 5.6)
14. Follow the procedure for a multipoint precision check (refer to Section 5.8).
15. The instrument is now ready for operation.

2.4 U.S. EPA Reference Set-Up

The Serinus 30 is designated as reference method RFCA-0509-174 by the U.S. EPA (40 CFR Part 53). The Serinus 30 must be used under the following conditions to satisfy this approval:

Range

0-50 ppm

Ambient Temperature

20-30 °C

Line Voltage

105-125 VAC, 60 Hz

Pump

Ecotech optional internal or external pump

Filter

Factory setup to meet requirement:

Instrument Settings

If the units in the measurement menu are changed from volumetric to gravimetric (or gravimetric to volumetric) the instrument must be re-calibrated.

The following menu selections must be used:

Measurement Settings Menu

Background Interval: 24 hrs

Calibration Menu

Span Comp: Disabled

Diagnostics Menu

Press/Temp/Flow Comp: On

Diagnostic Mode: Operate

Control loop: Enabled

The instrument must be operated and maintained in accordance with this User Manual.

The Serinus 30 analyser is designated U.S. EPA reference method with or without the following options/items:

- Internal pump
- Rack mount assembly
- Optional Ethernet Port

2.5 EN Type Approval Set-Up

The Serinus 30 has been certified to TUV performance standards for Continuous Ambient Air Quality Monitoring Systems. The certificate number is TUV 936/21221977/D. The Serinus 30 must be used under the following conditions to meet EN requirements:

Range

0-100 ppm

Ambient Temperature

0-30 °C

Instrument Settings

The instrument must be operated and maintained in accordance with this user manual.

The following menu selections must be used:

Measurement Settings

Background interval: 24 hrs

Calibration Menu

Span Comp: Disabled

Diagnostics Menu

Press/Temp/Flow Comp: On
Diagnostic mode: Operate
Control Loop: Enabled

2.6 Transporting/Storage

Transporting the instrument should be done with great care. It is recommended that the packaging the instrument was delivered in should be used when transporting or storing.

When transporting or storing the instrument the following points should be followed:

1. Turn off the instrument and allow it to cool down.
2. Remove all pneumatic, power and communication connections.
3. If storing over a long period (six months) turn the battery off by moving the switch (S1) on the main controller PCA (refer to Figure 9).
4. Remove the instrument from the rack.
5. Replace the red plugs into the pneumatic ports.
6. If transporting the instrument, replace the travel screws (refer to Figure 7).
7. Remove the USB memory stick and pack with instrument. (for location refer to Figure 8)
8. Place the instrument back into a plastic bag with desiccant packs and seal the bag (ideally the bag supplied upon delivery).
9. Place the instrument back into the original foam and box it was delivered in. If this is no longer available find some equivalent packaging that provides protection from damage.
10. The instrument is now ready for long term storage or transportation.

Note: After transport or storage the instrument must be set-up and calibrated (refer to Section 2.3.4).



Figure 8 – Installation of USB Memory Stick

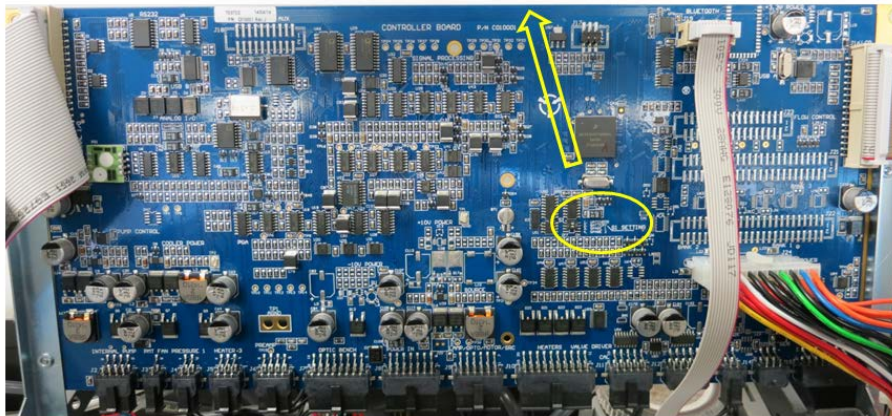

Figure 9 – Switching the Battery On/Off

This page is intentionally blank.

3. Operation

3.1 Warm-Up

When the instrument is first turned on it must go through a period of adjustment and calibration. No measurements are taken during this warm-up period.

The following activities occur during warm-up:

Auto Ref. Adjust

Adjusts the reference voltage and internal trim pot setting

Auto Zero Adjust

Adjusts the zero offset

Heat CO Scrubber

The instrument progressively increases the temperature of the CO scrubber until it reaches the desired temperature of 90 °C. When heating from cold, the scrubber will take approximately 20-30 minutes to reach desired temperature.

Cell Temperature

Wait until the cell temperature reaches at least 90 % of set point.

After this warm-up has completed the instrument will immediately begin making measurements (refer to Section 3.2).

3.2 Measurement

The Serinus 30 primarily operates in the sample cycle continuously. A background is performed after warm-up, once a day (at 23:45 as default) or when the chassis temperature changes by 4 °C. It is used to measure background absorption in the cell and is subtracted from sample measurements.

Table 2 – Measurements: Background and Sample Cycles

Instrument State	Duration (minutes)	Description
Background Fill	3	Measurement cell fills with background air
Background Meas	1	Measurement of background air
CO Sample Fill	3	Measurement cell fills with sample air
CO Sample Meas	Continuous	Measurement of sample air

3.3 General Operation Information

3.3.1 Keypad & Display

The instrument is operated with the use of four sets of buttons:

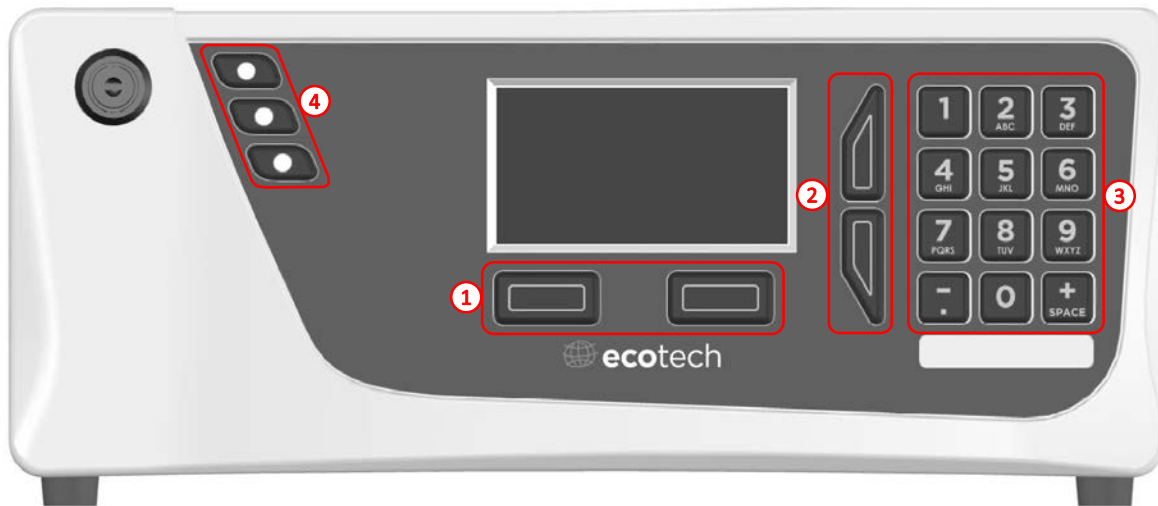

Figure 10 – Front Panel

Selection Buttons (1)

The selection buttons will perform the function specified directly above it on the screen. Generally this involves opening a menu, editing a value, accepting or cancelling an edit or starting an operation.

Scrolling Buttons (2)

The scrolling buttons allow users to scroll up and down through menus or selection boxes. The scrolling buttons are also used to scroll side to side through editable fields such as: Dates, Times, Numbers etc.

On the home screen these buttons are used for adjusting the screen contrast. Press and hold the up button to increase contrast; press and hold the down button to decrease.

Keypad (3)

The keypad contains the numbers 0-9, a decimal point/minus key ($\bar{.}$) and a space/plus key ($\bar{+}$).

In the few cases where letters can be entered, the number keys act like a telephone keypad. Every time a number key is pressed, it cycles through its choices. The up/down arrow keys scroll through all the numbers and the entire alphabet.

1 = 1, space, underline

2 = 2, A, B, C, a, b, c

3 = 3, D, E, F, d, e, f

4 = 4, G, H, I, g, h, i

5 = 5, J, K, L, j, k, l

6 = 6, M, N, O, m, n, o

7 = 7, P, Q, R, S, p, q, r, s

8 = 8, T, U, V, t, u, v

9 = 9, W, X, Y, Z, w, x, y, z

0 = 0, space, underline

The ($\overset{+}{SPACE}$) and ($\bar{\cdot}$) keys function is context dependent. When editing a floating point number, the ($\bar{\cdot}$) key inserts a negative sign if the editing cursor is at the start of the number and negative signs are allowed. Otherwise it moves the decimal place to the current cursor location. The ($\overset{+}{SPACE}$) key inserts a positive sign if the cursor is at the start of the number; otherwise it enters a space.

For non-floating point numbers, these keys usually increment or decrement the current value by 1.

When editing the month field of a date, the ($\overset{+}{SPACE}$) and ($\bar{\cdot}$) key change the month.

Instrument Status Light Buttons (4)

Located in the top left corner, these lights indicate the status of the instrument as a whole.

- A red light indicates that the instrument has a major failure and is not functioning.
- An orange light indicates there is a minor problem with the instrument, but the instrument may still take measurements reliably.
- A green light indicates that the instrument is working and there are no problems.

In the case of an orange or red light, the user can enter the **Status Menu** to find which components are failing (refer to Section 3.4.4) or press the orange or red status light button when illuminated to bring up a pop up box with a full list of current faults.

Pressing the green status light button at any time will cancel any open edit box or menu and return the user to the home screen.

If no instrument status lights are on and the keypad is backlit, this indicates that the instrument is running the bootloader. The screen will also indicate that it is in the bootloader menu.

3.3.2 Home Screen

The home screen is composed of seven parts: readings (1), error/status line (2), instrument activity line (3), selection buttons (4), time/date (5), concentration units (6) and USB status (7).

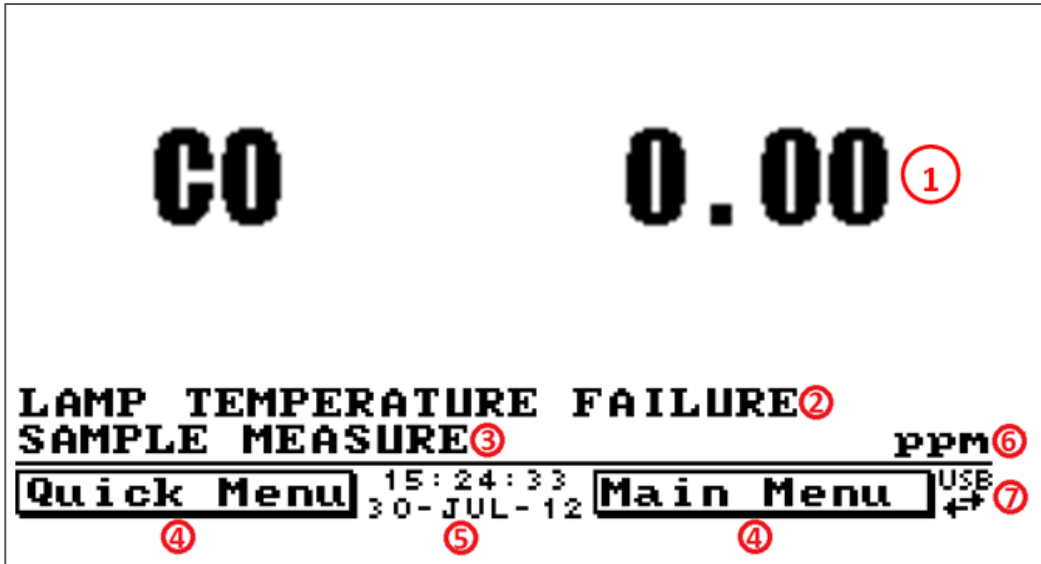

Figure 11 – Home Screen

Readings (1)

Displays the concentration being measured in real-time. The display can be configured to show just the instantaneous data or the instantaneous and average data (refer to Section 3.4.8 **Home Screen**).

Error/Status Line (2)

The error/status line provides users with information on any problems the instrument may have. It displays the highest priority error or status condition contained in the **Status Menu** (refer to Section 3.4.4).

Instrument Activity (3)

This line shows what function the instrument is currently performing. Generally, it will show three groups of actions: Warm-up, Measurement or Calibration.

Selection Buttons (4)

These buttons are used on the home screen to enter one of two menus. The **Quick Menu** (refer to Section 3.4.1) contains all information and features necessary for scheduled maintenance. The **Main Menu** (refer to Section 3.4.2) contains all information and fields available to users and is generally only used during initial set-up and diagnostics.

Time and Date (5)

The time and date are displayed in between the menu buttons at the bottom of the screen.

Concentration Units (6)

The instrument units are displayed in the bottom right hand corner of the display.

USB Detection (7)

A USB symbol will be displayed in the bottom right corner when the USB memory stick is plugged in (the USB socket is behind the front panel). If the USB symbol is not shown the USB memory stick should be inserted. Underneath, the USB symbol arrows may be displayed which indicates data transfer. The USB memory stick must not be removed whilst the arrows are visible.

Note: To safely remove the USB memory stick, navigate to the Quick Menu and use the Safely Remove USB Stick function (refer to Section 3.4.1).

3.4 Menus & Screens

The menu system is divided into two sections, the **Quick Menu** and the **Main Menu** selectable from the **Home Screen**. The **Quick Menu** contains all information and operations necessary during scheduled maintenance visits. The **Main Menu** contains all fields that are accessible to users. It provides information on component failures and measurement parameters as well as editable fields and test procedures.

In general, editable parameters are displayed in bold font. Non-editable information is displayed in a thin font. Some parameters may become editable based on the state of the instrument.

For example, the manual calibration type and mode can only be changed when the instrument has finished the warm-up process.

3.4.1 Quick Menu

The **Quick Menu** contains all the maintenance tools in one easy to use screen. It allows operators to perform calibrations, check important parameters and review the service history.

Span Calibrate CO

This field is used to perform a span calibration adjustment and should be only used when a known concentration of span gas is being drawn through the measurement cell and the reading is stable.

Activating the span calibrate field for a named gas will open a dialog box. Enter the concentration of the span gas that the instrument is sampling and press **Accept**.

Event Log

This field enters a screen with a log of all the events that the instrument has performed. These events include errors and warnings. This log is stored on the removable USB memory stick.

The log is organised by month. When you enter this screen you will be prompted to enter the month for which you wish to view events.

Instrument

This field allows the instrument to be set to either **Online** (normal instrument operation) or **In Maintenance** (data is flagged as invalid).

Safely Remove USB Stick	Always select this menu item before removing the USB memory stick or select the same menu item from the Service Menu (refer to Section 3.4.13). Failure to do this may cause corruption of the memory stick.
Instrument Gain	This is a multiplication factor which is used to adjust the concentration measurement to the appropriate level (set by performing a Span Calibrate CO). This should be recorded after each calibration in the station log book.
Next Service Due	A field that notifies the user when the next instrument service is due. This value is editable in the Next Service Due field of the Advanced Menu (refer to Section 3.4.31). This field is only displayed in the two weeks prior to the date displayed in this field or after the date has occurred.

3.4.2 Main Menu

There are six menus on the **Main Menu** screen.

Analyser State Menu	Refer to Section 3.4.3.
General Settings Menu	Refer to Section 3.4.8.
Measurement Settings Menu	Refer to Section 3.4.9.
Calibration Menu	Refer to Section 3.4.10.
Service Menu	Refer to Section 3.4.13.
Communications Menu	Refer to Section 3.4.22.

3.4.3 Analyser State Menu

Main Menu → Analyser State Menu

This displays the status of various parameters that affect instrument measurements.

Status Menu	Refer to Section 3.4.4.
Temperature Menu	Refer to Section 3.4.5.
Pressure & Flow Menu	Refer to Section 3.4.6.
Voltage Menu	Refer to Section 3.4.7.
Model	This field will always display Serinus.
Variant	The variant of the Serinus model (e.g. S30).
Range	The range of the Serinus model (Standard, High or Trace).
Ecotech ID	The Ecotech ID number.
Serial No.	The main controller PCA serial number.
Board Revision	The main controller PCA version.
Firmware Ver.	This field displays the firmware version currently in use on this instrument. This can be important when performing diagnostics and reporting back to the manufacturer.

Power Failure	This field displays the time and date of the last power failure or when power was disconnected from the instrument.
----------------------	---

3.4.4 Status Menu

Main Menu → Analyser State Menu → Status Menu

The **Status Menu** presents a list of the current **Pass/Fail** statuses of the main components. During warm-up, the status of some parameters will be a dashed line.

Event Log	This field enters a screen with a log of all the events that the instrument has performed. These events include errors and warnings. This log is stored on the USB memory stick. The log is organised by month. When you enter this screen you will be prompted to enter the month for which you wish to view events.
Show Error List	This field allows the user to display the list of current errors and warnings on the screen.
Next Service Due	This field is visible with the next service due date if the service is due within the next two weeks.
+5V Supply	Pass if the +5 V power supply is within the acceptable range.
+12V Supply	Pass if the +12 V power supply is within the acceptable range.
+Analog Supply	Pass if the analog power supply is within the acceptable range (+12 V).
-Analog Supply	Pass if the analog power supply is within the acceptable range (-12 V).
A2D	Fail only if a problem is detected with the analog to digital conversion.
Cell Temp.	Pass if the cell heater temperature is within $\pm 10\%$ of the heater set point.
CO Scrubber Temperature	Pass if the CO scrubber heater temperature is within $\pm 10\%$ of 90 °C.
Mirror Temp.	Pass if the mirror heater temperature is within $\pm 10\%$ of set point.
Lamp/Source	Fail if the reference voltage is less than 0.5 V and the input pot is over 250, which can be caused by the IR source failing.
Correlation Wheel	Fail if the correlation wheel is not functioning.
Ref Voltage	Checks that the reference voltage is within acceptable limits 3.6 V to 4.4 V.
IR Source	Checks that the IR source voltage is 5 V ± 0.5 V.
System Power	Pass if the system has an adequate electrical supply.
Maintenance Mode	Error if the system is “ In Maintenance ” (refer to Section 3.4.13).
Diagnostic Mode	Error if the electronics are in Diagnostic Mode (refer to Section 3.4.15).
Diagnostic PTF Comp	Error if the Pres/Temp/Flow Comp. is disabled (refer to Section 3.4.14).

Diagnostic Control	Error if the control loop is disabled (refer to Section 3.4.14).
Valve Manual Control	Error if the valve sequencing is disabled (refer to Section 3.4.17).
CO Conc V Saturated	Indicates if the voltage of the concentration during measurement is within the limits of the analog to digital converter (-0.26 V to 3.29 V).
Background Conc V Saturated	Indicates if the voltage of the concentration during background measurement is within the limits of the analog to digital converter (-0.26 V to 3.29 V).
Pressure Calibration	Error if the user is performing a pressure calibration.
Flow Calibration [Internal Pump Option]	Error if the user is performing a flow calibration.
Flow Fault	Ok when the instrument has acceptable sample flow based on the difference between cell and ambient pressures. With the internal pump option this fault is monitored by a flow sensor.
Flow Block Temp. [Internal Pump Option]	Pass if the flow block temperature is within 10 % of the heater set point (to keep a constant accurate flow).
Chassis Temperature	Pass if the chassis temperature is within the acceptable limits (0-50 °C).
USB Stick Disconnected	Detects whether a USB memory stick is plugged into the front USB port.
Instrument Warmup	Ok once the instrument is out of warm-up status.
Backgrounds Disabled	Ok if backgrounds is enabled.

3.4.5 Temperature Menu

Main Menu → Analyser State Menu → Temperature Menu

Temperature Units	The current temperature units of the instrument (Celsius , Fahrenheit or Kelvin).
Set Point (CELL)	The temperature set point of the measurement cell. The factory default is 50 °C.
Set Point (FLOW) [Internal Pump Option]	The temperature set point of the flow block heater. The factory default is 50 °C.
Cell	Displays current temperature of the measurement cell.
CO Scrubber	Displays current temperature of the CO Scrubber.
Flow Block [Internal Pump Option]	Displays the current temperature of the flow block.
Chassis	Displays the temperature of air inside the chassis, measured on the main controller PCA.
Mirror	Displays the temperature of the end-cap mirror plate on the measurement cell.

3.4.6 Pressure & Flow Menu

Main Menu → Analyser State Menu → Pressure & Flow Menu

Pressure Units	Select the units that the pressure will be displayed in (torr, PSI, mBar, ATM or kPa).
Ambient	Current ambient pressure.
Cell	Current pressure within the measurement cell.
Flow Units	Select the units that the sample flow will be displayed in (slpm or L/min).
Flow Set Point [Internal Pump Option]	The desired sample flow.
Sample Flow	Indicates the gas flow through the sample port of the instrument. The value should be around 1.0 slpm. If there is an error with the sample flow, it will read 0.00 slpm.

3.4.7 Voltage Menu

Main Menu → Analyser State Menu → Voltage Menu

IR Source	The drive voltage of the IR source 5 V ±0.5 V.
Conc Voltage (RAW)	Voltage from the sensor proportional to the detected signal from the measurement cell. This voltage represents the actual measurement of gas.
Conc Voltage	Displays the detector voltage after PGA scaling.
Ref. Voltage	The reference voltage is a measure of the IR source intensity.
Flow Voltage [Internal Pump Option]	The current voltage measured from the flow block PCA.
Cooler Voltage	Voltage of the peltier cooler within the IR detector (~1.17 V).
+5V Supply	+5 V power supply.
+12V Supply	+12 V power supply.
+Analog Supply	+12 V (primary) power supply. The value should be within ±2 V.
-Analog Supply	-12 V (primary) power supply. The value should be within ±2 V.

3.4.8 General Settings Menu

Main Menu → General Settings Menu

Decimal Places	Select the number of decimal places (0-5) used for the concentration displayed on the home screen.
Conc. Units	Sets the concentration units (ppm, ppb, ppt, mg/m3, µg/m3 or ng/m3).
Conversion Factor [Gravimetric Units]	This option only appears if concentration units are set to gravimetric (mg/m3, µg/m3 or ng/m3). Select either 0°C, 20°C or 25°C . This sets the standard temperature used from conversion for measured volumetric values.

Temperature Units	Select the units that temperature will be displayed in (Celsius , Fahrenheit or Kelvin).
Pressure Units	Select the units that the pressure will be displayed in (torr , PSI , mBar , ATM or kPa).
Flow Units	Select the units that the sample flow will be displayed in (slpm or L/min).
Date	Displays the current date and allows users to edit if required.
Time	Displays the current time and allows users to edit if required.
Backlight	Select the length of time the screen and keypad backlight remain on after a button press. The setting Always Off means the backlight never turns on; the setting Always On means the backlight never turns off.
Home Screen	This field allows the user to display concentrations on the Home Screen in two formats. The first is Inst. only which displays only the instantaneous concentration reading, the second is Inst & Avg which displays both instantaneous and average concentration on the Home Screen . The average is measured over the time period set in Measurement Settings Menu (refer to Section 3.4.9).
Char 0 has Slash	When enabled, the instrument will display the zero character with a slash (0) to differentiate it from a capital 'O'.

3.4.9 Measurement Settings Menu

Main Menu → Measurement Settings Menu

Average Period	Set the time period over which the average will be calculated: Minutes (1 , 3 , 5 , 10 , 15 or 30) or hours (1 , 4 , 8 , 12 or 24).
Filter Type	Sets the type of digital filter used (None , Kalman , 10 sec , 30 sec , 60 sec , 90 sec , 300 sec or Rolling). The Kalman filter is the factory default setting and must be used when using the instrument as a U.S. EPA equivalent method or to comply with EN certification. The Kalman filter gives the best overall performance for this instrument.
Rolling Size [Rolling Filter]	Sets the number of measurements included in the rolling average. Only available if the Filter Type is set to Rolling .
Backgrounds	The default setting is enabled. When enabled it allows the user to edit the background interval via the following fields Time , Repeat and Units . When any of the backgrounds fields are edited the instrument will automatically calculate the date and time the next background is due to run and display under each relevant field.
Date [Backgrounds]	Displays the date that the next background is due to run.
Time [Backgrounds]	Edit and display the time that the next background will run. The time is set using a 24 hour clock.

Repeat [Backgrounds]	Defines an interval value for the repeat of the background based on the Units selected. This field indicates the delay period; once the specified amount of time has lapsed the background will automatically run again. The user can edit this field but some restriction apply depending on the Units selected. Default is "1".
Units [Backgrounds]	This is where the user can define the type of units for the Repeat delay period. For example: A Repeat of "1" and Units of "Days" means that a calibration will automatically run every day at the defined time. Default is "Days"

3.4.10 Calibration Menu

Main Menu → Calibration Menu

Calibrating the instrument should be done with care (refer to Section 5 before using these menus).

Cal. Type	<p>Depending on the selection in this field, a number of extra menu items will be displayed. These are separately documented in Manual Mode (refer to Section 3.4.10.1) and Timed Mode (refer to Section 3.4.10.2).</p> <p>Select the Cal. Type field and select either Timed or Manual. Timed mode is an automatic calibration controlled by the:</p> <ul style="list-style-type: none"> ▪ Interval between cycles ▪ Length of each calibration cycle ▪ Time when the calibration will begin ▪ Check only or automatic compensation <p>Timed calibration with span compensation enabled does not fulfil U.S. EPA approval.</p> <p>Manual mode allows you to choose the type of calibration you wish to perform and will open the appropriate valves in preparation for the user to perform a manual calibration. The setup used will depend on the Cal. Mode selected. Manual mode is set as default.</p>
Zero Source	Select whether the instrument will sample from the external calibration port or from the internal zero source when zero gas is requested.
Cycle Time	The duration of each Cal. Mode (span and zero) when performing Cycle Mode (refer to Section 3.4.10.1) or Cal. Type is set to Timed . (refer to Section 3.4.10.2)
Span Calibrate CO	<p>This field is used to perform a span calibration and should be only used when a known concentration of span gas is running through the measurement cell and the reading is stable.</p> <p>Activating the span calibrate field for a named gas will open a dialog box. Enter the concentration of the span gas that the instrument is sampling and press Accept.</p>
Zero Calibrate CO	This command is used to correct the zero calibration setting. This option should be used only when zero gas is running through the measurement cell (refer to Section 5.5 before using this command).
Manual Background	Immediately perform a background.

Pressure Calibration Menu	Refer to Section 3.4.11.
Flow Calibration Menu [Internal Pump Option]	Refer to Section 3.4.12.
Pressure CO	This field displays the cell pressure measured during the last calibration.
Temperature	Cell temperature when the last span calibration was performed.

3.4.10.1 Manual Mode

These items appear in the **Calibration Menu** when **Cal. Type** is set to **Manual**.

Cal. Mode	<p>When calibration type is set to Manual the instruments operational mode can be chosen from the following:</p> <ul style="list-style-type: none"> ▪ Measure: Is the normal measurement through the sample port. ▪ Zero: This mode will take air through the calibration port so that a zero calibration can be performed. Data is flagged as zero data. ▪ Span: This mode will take air through the calibration port so that a span calibration can be performed. Data is flagged as span data. ▪ Cycle: Performs a zero and a span calibration mode and returns to measure mode. The length of time spent measuring each calibration mode is set in Cycle Time (refer to Section 3.4.10). <p>While the instrument is still in the warm-up period (refer to Section 3.1) the Cal. Mode cannot be changed from Measure mode.</p>
------------------	---

3.4.10.2 Timed Mode

These items appear in the **Calibration Menu** when **Cal. Type** is set to **Timed**.

Date	Enter the date for the next calibration to start.
Time	Enter the time that calibration will be performed. The time is set using a 24 hour clock.
Repeat	The calibration will automatically run again after the specified amount of time. This field specifies the delay period (from 1 to 20,000 units, as specified below).
Units	This is where the user can define the type of units for the Repeat delay period. For example: A Repeat of "3" and units of "Days" means that a calibration will automatically be performed every three days.
Span Compensation	<p>When Enabled the instrument will automatically perform a Span Calibrate CO at the end of the Cycle Time and adjust the gain based on the Span Level.</p> <p>When Disabled it will do a precision check only, no adjustment is made.</p> <p>Timed calibration with span compensation enabled does not fulfil U.S. EPA approval or EN certification.</p>

Span Level	Enter the concentration of span gas expected. Used when the Span Compensation is Enabled .
-------------------	--

3.4.11 Pressure Calibration Menu

Main Menu → Calibration Menu → Pressure Calibration Menu

Entering this menu will set the valves to the pressure calibration configuration; leaving the menu will restore the valves to normal operation (refer to Section 5.2).

Vacuum Set Pt.	The zero point for the calibration. Activating this item will open a dialog box of instructions.
Ambient Set Pt.	The high point for the calibration. Activating this item will open a dialog box of instructions.
Pressure Units	Select the units that the pressure will be displayed in (torr, PSI, mBar, ATM or kPa).
Ambient	The current ambient pressure.
	The current ambient pressure displayed as a raw voltage.
Cell	The current pressure in the measurement cell.
	The current measurement cell pressure displayed as a raw voltage.

3.4.12 Flow Calibration Menu (Option)

Main Menu → Calibration Menu → Flow Calibration Menu

This menu only appears when the internal pump option is installed. Please refer to Section 5.9 for the calibration procedure. Setting the **Flow Control** to **MANUAL** will automatically disable the valve sequencing ready for flow calibration.

Flow Control	Set to MANUAL to disable the automatic flow control. AUTO allows the flow PID to modify the pump coarse and fine settings. START will transition to AUTO after one second.
Internal Pump	This field allows the internal pump to be turned on or off. This field is only editable when the Flow Control field is set to MANUAL .
Coarse	Internal pump speed control (Coarse). This field is only editable when the Flow Control field is set to MANUAL .
Fine	Internal Pump speed control (Fine). This field is only editable when the Flow Control field is set to MANUAL .
Sample Flow	Current sample flow through the instrument. This is only accurate when reading close to the flow calibration point.
Flow Set Point	The desired sample flow target.

Cal. Point	The flow at which the last flow calibration was performed. If Flow Control is set to MANUAL and Internal Pump is ON , this field can be edited to calibrate the current flow against a reference. Calibration must be done at or near the flow set point for best results (refer to Section 5.9).
Cal. Zero	If Flow Control is set to MANUAL and Internal Pump is OFF , activating this command will calibrate the flow sensor zero point (refer to Section 5.9).
Valve Menu	Refer to Section 3.4.17.

3.4.13 Service Menu

Main Menu → Service Menu

Diagnostics Menu	Refer to Section 3.4.14.
Calculation Factors Menu	Refer to Section 3.4.21.
Load Auto-Backup Config.	Loads the auto-backup configuration file. The configuration is automatically backed up every night at midnight.
Load Configuration	Loads a user selectable configuration file from the USB memory stick.
Save Configuration	Saves all of the EEPROM-stored user-selectable instrument configurations to the USB memory stick (calibration and communication settings, units, instrument gain, etc.). If there are problems with the instrument use this function to save settings to the USB memory stick and send this file (together with the parameter list save) to your supplier with your service enquiry.
Save Parameter List	Saves a text file of various parameters and calculation factors. If you have problems with the instrument use this function to save settings to the USB memory stick and send this file (together with the configuration save) to your supplier with your service enquiry.
Instrument	This field allows the instrument to be set to either Online (normal instrument operation) or In Maintenance (data is flagged as invalid).
Next Service Due	Displays when the next scheduled service is due.
Safely Remove USB Stick	This command must be activated to safely remove the USB memory stick.
System Restart	Activating this will restart the instrument.

3.4.14 Diagnostics Menu

Main Menu → Service Menu → Diagnostics Menu

Digital Pots Menu	Refer to Section 3.4.15.
Internal Pump Menu [Internal Pump Option]	Refer to Section 3.4.16.
Valve Menu	Refer to Section 3.4.17.

Tests Menu	Refer to Section 3.4.18.
Pres/Temp/Flow Comp.	<p>On (default): Is used to compensate instrument measurements for environmental fluctuations that might affect readings (pressure, temperature and flow).</p> <p>Off: Is used only when running diagnostics.</p>
Control Loop	<p>Enabled (default): Allows the instrument to automatically adjust digital pots and other outputs.</p> <p>Disabled: Prevents the instrument from changing most outputs so the service technician can manually control them.</p>

3.4.15 Digital Pots Menu

Main Menu → Service Menu → Diagnostics Menu → Digital Pots Menu

Digital pots are electronically controlled digital potentiometers used for adjustments to operations of the instrument. Each of the digital pots can go from 0-255. This menu should be accessed only during diagnostics.

Unless the **Control Loop** is **Disabled** (refer to Section 3.4.14), changes to the pots may be modified by the instrument. This is intentional; some diagnostics are best done with instrument feedback and some are best done without.

PGA Gain	1-128	Displays the gain of the PGA.
Input Pot	180-230	Reduces the raw signal to measurable level.
Conc. Voltage (RAW)	0-3.1	The concentration voltage measured by the analog to digital converter.
Conc. Voltage	0-3.1	The concentration voltage after adjustment for the PGA gain factor.
Meas. Zero Pot (COARSE)	125-225	Electronic zero for the measure channel.
Meas. Zero Pot (FINE)	0-255	Electronic zero for the measure channel.
Ref. Test Pot	0	For diagnostics only.
Ref. Voltage	3.5-4.5	The reference voltage of the detector.
Source Pot	227	Adjusts the drive current for the IR source.
Cooler Pot	45	Adjusts the drive current for the cooler.
Cooler Voltage	1.15-1.20	The voltage being applied to the cooler.
Test Meas Pot	0	This Digital Pot is used for diagnostics only. When in the Electrical or Preamp Diagnostic Mode , this Digital pot should be adjusted from 0 to 255. This will produce a change in the concentration voltage as well as the indicated gas concentration.
Test Ref Pot	0	This Digital Pot is used for diagnostics only. When in the Electrical or Preamp Diagnostic Mode , this Digital Pot should be adjusted from 0 to 255. This will produce a change in the reference voltage.
Diagnostic Mode	Operate	<ul style="list-style-type: none"> Operate (default): Puts the instrument in normal operation mode. Electrical: Injects an artificial test signal into the electronic processing circuitry on the main controller PCA to verify that the circuitry is operating correctly. When in this Diagnostic Mode, adjust the Test Meas Pot from 0 to 255. This will produce a change

in the concentration voltage as well as the indicated gas concentration. Adjust the **Test Ref Pot** from 0 to 255 to produce a change in the reference voltage.

- **Preamp:** Injects an artificial test signal into the Preamplifier mounted on the **Measurement Cell** to verify that the Preamplifier, cabling and electronic circuitry on the main controller PCA is operating correctly. When in this **Diagnostic Mode**, adjust the **Test Meas Pot** from 0 to 255. This will produce a change in the concentration voltage as well as the indicated gas concentration. Adjust the **Test Ref Pot** from 0 to 255 to produce a change in the reference voltage.

3.4.16 Internal Pump Menu (Option)

Main Menu → Service Menu → Diagnostics Menu → Internal Pump Menu

This menu only appears when the internal pump option is installed. Setting the Flow Control to MANUAL will automatically disable the valve sequencing.

Flow Control	Set to MANUAL to disable the automatic flow control. AUTO allows the flow PID to modify the pump coarse and fine settings. START will transition to AUTO after one second.
Internal Pump	This field allows the internal pump to be turned on or off. This field is only editable when the Flow Control field is set to MANUAL .
Coarse	Internal pump speed control (Coarse). This field is only editable when the Flow Control field is set to MANUAL .
Fine	Internal Pump speed control (Fine). This field is only editable when the Flow Control field is set to MANUAL .
Sample Flow	Current gas flow. This is only accurate when reading close to the flow calibration point.

3.4.17 Valve Menu

Main Menu → Service Menu → Diagnostics Menu → Valve Menu

The **Valve Menu** allows the user to observe the instrument controlled switching of the valves. If the valve is On it means the valve is energised. When a three way valve is in the On state it will now be in the NC (normally closed) position as shown in the plumbing schematic. When the valve sequencing is disabled the user has the ability to turn the valve Off and On manually. It is recommended that the valve menu be used by a trained technician following the plumbing schematic (refer to Section 9.5).

Note: When interpreting the information below regarding the flow path through the valve note that (NC = Normally Closed), (NO = Normally Open) and (C = Common).

Valve Sequencing	When Enabled the valves will turn On and Off under the instruments control (even if you have manually turned Off or On a valve). When Disabled the valves will change only in response to a user's action.
-------------------------	---

Sample/Cal	Indicates if the Sample/Cal valve on the Calibration Valve Manifold is Off or On . This will determine the port the instrument draws its sample from. Off = Flow from NO to C (drawing sample from the Sample Port). On = Flow from NC to C (drawing sample from the Calibration Port).
Internal Zero/Cal	Indicates if the Internal Zero/Cal valve on the Calibration Valve Manifold is Off or On . This will determine the port the instrument draws its sample from, when selecting Cal. Mode → Zero . Off = Flow from NO to C (drawing sample from the BGnd Air Port). On = Flow from NC to C (drawing sample from the Calibration Port).
Pressurised Zero [optional]	Indicates if the optional pressurised zero port valve is Off or On (refer to Section 8.6).
Pressurised Span [optional]	Indicates if the optional pressurised span port valve is Off or On (refer to Section 8.6).

3.4.18 Tests Menu

Main Menu → Service Menu → Diagnostics Menu → Tests Menu

Screen Test	Performs a screen test by drawing lines and images on the screen so that the operator can determine if there are any faults in the screen. Press a keypad key to step through the test. The up and down arrow keys will adjust the contrast.
Digital Input Test Menu	Refer to Section 3.4.19.
Digital Output Test Menu	Refer to Section 3.4.20.

3.4.19 Digital Input Test Menu

Main Menu → Service Menu → Diagnostics Menu → Tests Menu → Digital Input Test Menu

Input 0..7	Displays the status of the 0-7 digital input pins. Value will be 0 or 1.
-------------------	--

Note: Entering the **Digital Inputs Menu** will temporarily disable all digital and analog input/outputs. This will affect logging via these outputs. Exiting the menu restores automatic control.

3.4.20 Digital Output Test Menu

Main Menu → Service Menu → Diagnostics Menu → Tests Menu → Digital Output Test Menu

Automated Test	When started will automatically step through each output, turning it On and Off.
Output 0..7	Displays the state of the output pin (On or Off), and allows the user to manually set the state.

Note: Entering the **Digital Outputs Menu** will temporarily disable all digital and analog input/outputs. This will affect logging via these outputs. Exiting the menu restores automatic control.

3.4.21 Calculation Factors Menu

Main Menu → **Service Menu** → **Calculation Factors Menu**

The **Calculation Factors Menu** provides the user with the values used to calculate different aspects of measurement and calibration.

Dilution Ratio	<p>Entering a value here will multiply the displayed and recorded measurements by the dilution amount. For example, if the instrument is measuring a source where the average concentration is above the upper limit of the measurement range, a dilution probe with a fixed ratio dilution ratio can be used to reduce the level measured by the instrument, so for a 4:1 dilution ratio, enter a value of 4.</p> <p>Enter the ratio here so the instrument can display the correct value on the instrument.</p> <p>The default value is 1.00 (this indicates no dilution is applied).</p>
Instrument Gain	<p>A multiplication factor used to adjust the concentration measurement to the appropriate level (set at calibration).</p>
Zero Offset CO	<p>This field displays the offset created from a zero calibration. This is the concentration measured from zero air and is subtracted from all readings.</p>
Background	<p>The correction factor calculated from the background cycle (used to eliminate background interferences).</p>
PTF Correction CO	<p>Displays the correction factor applied to the concentration measurement. This correction is for changes in pressure, temperature and flows since the last calibration.</p>
Noise	<p>The standard deviation of the concentration. The calculation is as follows:</p> <ul style="list-style-type: none"> ▪ Take a concentration value once every two minutes. ▪ Store 25 of these samples in a first in, last out buffer. ▪ Every two minutes, calculate the standard deviation of the current 25 samples. This is a microprocessor-generated field and cannot be set by the user. <p>This reading is only valid if zero air or a steady concentration of span gas has been supplied to the instrument for at least one hour.</p>

3.4.22 Communications Menu

Main Menu → **Communications Menu**

Configures how the instrument communicates with external instrumentation and data loggers.

Data Logging Menu	Refer to Section 3.4.23.
Serial Communication Menu	Refer to Section 3.4.24.
Analog Input Menu	Refer to Section 3.4.25.

Analog Output Menu	Refer to Section 3.4.26.
Digital Input Menu	Refer to Section 3.4.27.
Digital Output Menu	Refer to Section 3.4.28.
Network Menu	Refer to Section 3.4.29.
Bluetooth Menu	Refer to Section 3.4.30.

3.4.23 Data Logging Menu

Main Menu → Communications Menu → Data Logging Menu

When editing the numeric or text menus, the “-” key will delete the current parameter and move the others up to take its place; the “+” key will insert a parameter at the current location and move the ones below it down. The internal logger can log a maximum of 12 parameters.

Data Log Interval	Displays the interval at which the data is saved to the USB memory stick. Selecting a 1 sec interval may result in occasional measurements not being logged or slow response to serial commands.
Data Log Setup –Numeric	Numeric list of the parameters logged. This is a quicker way to enter parameters (for a list of parameters refer to Table 25).
Data Log Setup –Text	Select the list of logged parameters by name.

3.4.24 Serial Communication Menu

Main Menu → Communications Menu → Serial Communication Menu

Serial ID	This is the ID of the instrument when using multidrop RS232 communications. This ID can be changed to support multiple instruments on the same RS232 cable.
Bayern-Hessen ID [Bayern-Hessen Protocol]	This is the Bayern-Hessen ID used by the Bayern-Hessen Protocol.
CO ID [Bayern-Hessen Protocol]	This is the ID of the CO gas used by the Bayern-Hessen Protocol.
CO2 ID [Bayern-Hessen Protocol] [Input 1 is CO2 Option]	This is the ID of the CO ₂ gas used by the Bayern-Hessen Protocol. This option is only available if you have installed the Input 1 is CO2 option in the Hardware Menu (refer to Section 3.4.32).
Service port (RS232 #1) Multidrop port (RS232 #2)	The port parameters below are repeated for each serial port.
Serial Delay	Some older communication systems require a delay before the instrument responds to a serial command. The number of milliseconds of delay required (0-1000). The default is 0, meaning the instrument responds as quickly as possible to any serial request.
Baudrate	Sets the baud rate for this serial port (1200, 2400, 4800, 9600, 14400, 19200, 38400 or 115200).

Protocol	Sets the protocol used for this serial port (Advanced , ModBus , EC9800 or Bayern-Hessen). This must be set to Advanced for Ecotech supplied software.
Endian [Modbus Protocol]	Select Little or Big endian mode for ModBus protocol.

3.4.25 Analog Input Menu

Main Menu → Communications Menu → Analog Input Menu

The Serinus supports three analog inputs from the 25 pin I/O connector. Each input is a 0 to 5 volt CAT 1 input that can be scaled and logged to the USB memory stick or accessed remotely as parameters 199 to 201.



CAUTION

Exceeding these voltages can permanently damage the instrument and void the warranty.

Input 1 is CO2	When enabled several new menu items appear in other menus and the home screen now displays the CO and CO2 gas concentrations.
Input 1/2/3	The sections below are repeated for each analog input.
Multiplier	The input voltage will be multiplied by this number. For example, if a sensor has a 0-5 V output for a temperature of -40 °C to 60 °C, the multiplier would be $(60 - (-40)) / 5 = 20$.
Offset	This value will be added to the above calculation. Continuing the example in the multiplier description, the offset should be set to -40, so that a voltage of 0 V will be recorded as -40 °C.
Reading	The current reading from the analog input, after the multiplier and offset are applied. This is the value that is logged or reported as parameter 199 to 201.

3.4.26 Analog Output Menu

Main Menu → Communications Menu → Analog Output Menu

Output Mode	The analog output can be set to be either Current or Voltage . Different fields will be displayed depending on which analog output type is selected.
CO CO2 [optional]	The first analog output is always CO. If you have enabled the Input 1 is CO2 option in the Hardware Menu (refer to Section 3.4.32), the second analog output will be CO2 and all of these fields will be repeated for both analog output.
Min Range	Sets the lower range limit (in concentration units). This is the value at which the analog output should be at its minimum. For example, 4 mA for a 4 to 20 mA current output.

Max Range	Sets the upper range limit (in concentration units). This value can be edited but cannot exceed the Over Range value. This is the value at which the analog output should be at its maximum. For example, 20 mA for a current output.
Over-Ranging	Set to Enabled or Disabled to turn the over-ranging feature on or off.
Over-Range [Over-Ranging Enabled]	This field is only visible when Over-Ranging is set to Enabled . Set to the desired over range value. This value cannot be set below the Range value. This is the alternate scale that is used for the analog output when over-ranging is active and enabled. When 90 % of the standard range is reached, this over range is automatically entered. When 80 % of the original range is reached, it returns to the original range.

3.4.26.1 Analog Output Menu - Voltage

Main Menu → Communications Menu → Analog Output Menu

These items appear when **Output Mode** is set to **Voltage**.

Voltage Offset	Choices are 0 V , 0.25 V or 0.5 V . This sets the voltage for a reading of 0. Since the output cannot go negative, this offset can be used to record negative readings.
0.5V Calibration	Enables the user to calibrate the analog voltage output at a low point. Edit the value against a reference volt meter until the connected equipment reads 0.5 V (refer to Section 4.4.1.1).
5.0V Calibration	Enables the user to calibrate the voltage output at a full scale point (5 V). Edit the value against a reference volt meter until the connected equipment reads 5 V (refer to Section 4.4.1.1).

3.4.26.2 Analog Output Menu - Current

Main Menu → Communications Menu → Analog Output Menu

These items appear when **Output Mode** is set to **Current**.

Current Range	Enables the user to set desired current ranges. The user's choices are 0-20 mA , 2-20 mA or 4-20 mA .
4mA Calibration	Enables the user to calibrate the current output at a low point. Edit the value against a reference amp meter until the connected equipment reads 4 mA (refer to Section 4.4.1.2).
20mA Calibration	Enables the user to calibrate the current output at a full scale point (20 mA). Edit the value against a reference amp meter until the connected equipment reads 20 mA (refer to Section 4.4.1.2).

3.4.27 Digital Input Menu

Main Menu → Communications Menu → Digital Input Menu

This menu is used to remotely trigger zero and span calibrations. This is done by assigning the eight digital inputs with one of the following commands.

DI N (Pin X)	Associates an action with a digital input. There are eight digital inputs (the pin numbers are for the 25 pin connector). Each one can have one of the following associated actions, triggered when the corresponding digital input goes to the Active state: <ul style="list-style-type: none">▪ Disabled: No action (this digital input does nothing).▪ Do Span: Used to perform a span precision check. When activated the instrument sets the Cal. Mode to Span (refer to Section 3.4.10.1).▪ Do Zero: Used to perform a zero precision check. When activated the instrument sets the Cal. Mode to Zero (refer to Section 3.4.10.1).
Active	Each pin can be set to be active High or Low . Active High means that the event will be triggered when the line is pulled to 5 V. Active Low means that the event will be triggered when the line is pulled to 0 V.

Example

Here is a typical configuration between an instrument and either a data logger or calibrator (master device):

1. Set the jumper JP1 to 5 V position (refer to Section 4.4.3).
2. Connect one of the master devices digital output signals to pin 18 and the ground signal to pin 5 of the instrument's analog/digital 25 pin female connector (refer to Figure 20).
3. Program master device to output 0 volts to pin 18 when a span is desired.
4. In the instrument's **Digital Input Menu** assign **DI 0 → Do Span** - Accept.
5. The same procedure can be followed to also activate zero calibrations. Pin 6 of the instrument's analog/digital 25 pin female connector can be connected to one of the other master devices digital outputs and the instrument can be set so **DI 1** is assigned to **Do Zero**.

3.4.28 Digital Output Menu

Main Menu → Communications Menu → Digital Output Menu

This allows the instrument to trigger external alarms in response to certain events. There are eight different pins available, which will be set high during an associated event:

DO N (Pin X)	Associates a state with a digital output. There are eight digital outputs (the pin numbers are for the 25 pin connector). Each one can have one of the associated states listed in Table 3. The pin will be driven to the active state while the instrument state is true.
Active	Each pin can be set to be active High or Low . Active High means that the pin will be pulled to 5 V when the associated event occurs. Active Low means the pin will be pulled to 0 V when the associated event occurs.

Table 3 – Digital Output States

Digital Output State	Description
Disabled	No state (this state is never Active).
Pwr Supply Fail	Power supply fault.
A2D Fail	Analog to digital fault.
Corr. Wheel Fail	Correlation wheel fault.
Flow Fail	Sample flow fault.
Cell Heat Fail	Cell heater fault.
Conv. Heat Fail	CO Scrubber heater fault.
Flow Heat Fail	Flow block heater fault.
Mirror Heat Fail	Mirror heater fault.
Lamp Heat Fail	Lamp heater fault.
Chassis Tmp Fail	Chassis temperature fault.
USB Disconnected	The USB memory stick is disconnected.
Background	Performing a background.
Span	Performing a span check.
Zero	Performing a zero check.
System Fault	Any system fault (the red light is on).
Maintenance Mode	User has activated maintenance mode.
Over Range AO 1	Over range for the CO analog output is active.
Over Range AO 2	Over range for the CO2 analog output is active.

3.4.29 Network Menu (Option)

Main Menu → Communications Menu → Network Menu

The **Network Menu** only appears when the **Network Port** is enabled in the **Hardware Menu** (refer to Section 3.4.32). The **Network Menu** allows the user to view or set the IP Address, Netmask and Gateway if the optional network port is installed.

Start-up Mode	The following modes are available: <ul style="list-style-type: none"> ▪ Normal: In this mode nothing is done with the network port during boot-up. It is assumed to be configured correctly or unused. ▪ Read IP: This mode interrogates the network port for its IP address. The menu will display the network address after boot-up. ▪ Set IP: The user may enter an IP address, Netmask and Gateway address (following the usual rules for formatting these addresses). At this time the instrument does not validate the correctness of these entries. When you cycle power, the instrument will first instruct the network port on its new address. It will switch to Read IP mode and read back the address it just set so the user may verify it in the menu. ▪ Set DHCP: This sets the network port into DHCP mode, allowing the network to assign the instrument an IP address.
IP Address [Read IP or Set IP Start-up Mode]	This is the current IP address of the instrument.
Netmask [Read IP or Set IP Start-up Mode]	This is the subnet mask of the network the instrument is connected to.
Gateway [Read IP or Set IP Start-up Mode]	This is the IP address of the router to access addresses not on the same subnet.
Adaptor is in DHCP mode [Set DHCP Start-up Mode]	In this mode the instrument will ask for its network parameters from a DHCP server on your network.
Protocol	Sets the protocol used for the network port (Advanced, ModBus, EC9800 or Bayern-Hessen). This must be set to Advanced for Ecotech supplied software.
Endian [Modbus Protocol]	Select Little or Big endian mode for ModBus protocol.
Bayern-Hessen ID [Bayern-Hessen Protocol]	This is the Bayern-Hessen ID used by the Bayern-Hessen Protocol.
CO ID [Bayern-Hessen Protocol]	This is the ID of the CO gas used by the Bayern-Hessen Protocol.
CO2 ID [Bayern-Hessen Protocol] [Input 1 is CO2 Option]	This is the ID of the CO ₂ gas used by the Bayern-Hessen Protocol. This option is only available if you have enabled the Input 1 is CO2 option in the Hardware Menu (refer to Section 3.4.32).

3.4.30 Bluetooth Menu

Main Menu → Communications Menu → Bluetooth Menu

This instrument supports Bluetooth communication through the Serinus Remote Android Application (refer to Section 4.7).

Bluetooth	This field indicates whether the instrument is remotely connected to an Android device.
Reset	After changing the ID or PIN, it is necessary to reboot the Bluetooth module. This is done by resetting the instrument or by using this menu item to reboot only the Bluetooth.
ID	This is the Bluetooth ID of the instrument. Use the keypad to edit this field. The default ID setting is Serinus(Ecotech ID) . The word Serinus is always the first part of the name and cannot be edited. The second part is the Ecotech ID .
PIN	This is a passcode/pin required for the Serinus Remote Application to connect to the instrument. The default pin is 1234.

3.4.31 Advanced Menu

This menu is accessed via a different method than the other menus. From the **Home Screen** press the following keys: **(-)99(+)**_{SPACE}

This menu contains technical settings, diagnostics and factory hardware installations. No items in this menu should be accessed without authorisation and supervision of qualified service personnel.

Language	Select a language.
Hardware Menu	Refer to Section 3.4.32
Service Displays	When set to On , new items appear on many different menus. These fields are for diagnostic and service personnel only. Default is Off .
Next Service Due	Enables the user to edit the next service due date.
Jump to Next State	Moves the sequence to the next state (e.g. from Fill to Measure). This command is most commonly used to force an instrument out of the warm-up sequence early.
Parameter Display Menu	Refer to Section 3.4.33.
Reset to Factory Defaults	Reset the configuration to factory defaults. This will erase all calibrations and user configuration information.
Rebuild Index	If a data log becomes corrupted it may be possible to restore it by rebuilding its index file. This command will ask you to specify a month and will rebuild the index for that month. This operation can take many minutes and it should not be interrupted. While the file is rebuilding any data logging will be suspended.



CAUTION

No items in this menu should be accessed without authorization and supervision of qualified service personnel.

3.4.32 Hardware Menu

Advanced Menu → Hardware Menu

This menu contains factory hardware installations. If you reset to factory defaults you may need to revisit this menu to enable your installed optional features.

Variant	Select the instrument model. Normally this only needs to be reset when the configuration is corrupted. The selections available will depend on licensing. It is not recommended to run an instrument with firmware set to an incorrect model.
Range	Select the range of the instrument. Not all instruments support all ranges. Default is Standard .
Front Panel Style	Choosing the incorrect front panel will result in the traffic lights behaving inconsistently. Default is Aluminium .
Network Port	When Enabled indicates the instrument has a network port installed. Default is Disabled .
Internal Pump	When Enabled indicates the instrument has an Internal pump installed. Default is Disabled .
Orifice Size [Internal Pump Option Disabled]	Specify the input orifice for instruments without an internal pump. Default is 1.08 for Standard range instruments and 1.50 for High range instruments.
Input 1 is CO2	When Enabled , analog input 1 is treated as a measurement of CO ₂ . This gas will appear on the Home screen and can be logged as the second gas. Default is Disabled .
AO Max Limit	Edit this menu item to set the lower limit of the analog output Max Range.



CAUTION

No items in this menu should be accessed without authorization and supervision of qualified service personnel.

3.4.33 Parameter Display Menu

Advanced Menu → Parameter Display Menu

Used to display a parameter in real-time on the screen (refer to Table 25 for a full list of parameters).

Data Parameter	This is an editable field. Enter the parameter number you wish to view (refer to Table 25)
Name	Displays the name of the selected parameter.
Value	Displays the current value of the selected parameter.

4. Communications

The Serinus has a number of different interfaces for communication with other equipment (RS232, USB, 25 pin digital/analog input/output, TCP/IP network (optional) and Bluetooth). A demonstration version of Ecotech's **Airodis** software is included with the instrument, enabling basic data downloads and remote operation from a PC running MS Windows (7 or 8). The full version of Airodis is available separately and includes automated data collection, data validation and complex reporting by multiple users. Please refer to the Airodis Manual and Section 4.6 for details on setting up and communicating with the instrument.

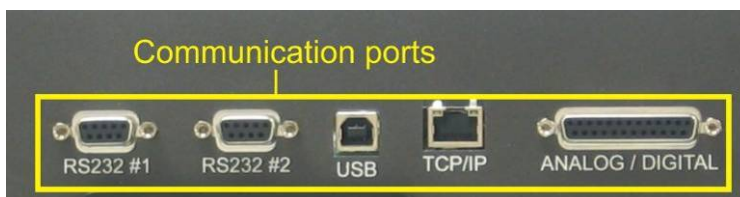

Figure 12 – Communication Ports

4.1 RS232 Communication

RS232 communication is a very reliable way to access data from the instrument and is recommended for use in connection to a data logger for 24/7 communication. Both RS232 ports are configured as DCE and can be connected to DTE (Data Terminal Equipment such as a data logger or computer).

Port #2 also supports a multidrop arrangement (a configuration of multiple instruments connected via the same RS232 cable where the transmit signal is only asserted by the instrument that is spoken to).

For reliable multidrop RS232 communications please follow these guidelines:

- Verify that the Serial ID is set to a unique value which is different to the other instruments in the chain (refer to Section 3.4.24).
- All of the instruments in the multidrop chain must have the same baud rate and communication protocol settings. A maximum of 9600 baud rate is recommended.
- The multidrop RS232 cable should be kept to less than three meters in length.
- A 12K ohm terminating resistor should be placed on the last connector of the cable (connect from pin 2 to pin 5 and from pin 3 to pin 5 – refer to Figure 13).
- The shielding of the multidrop cable must be continuous throughout the cable.
- The shielding of the multidrop cable must only be terminated at one end. It should be connected to the metal shell of the DB 9 way connector.

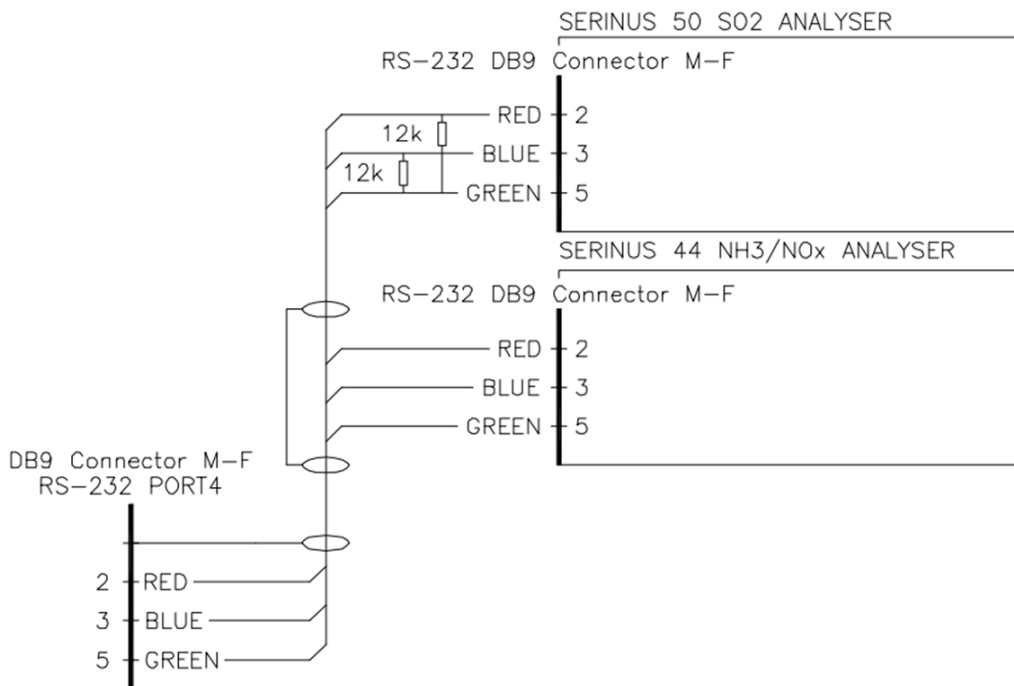

Figure 13 – Multidrop RS232 Cable Example

4.2 USB Communication

This is ideal for irregular connection to a laptop running Ecotech’s **Airodis** software to download logged data and remotely control the instrument. Due to the nature of USB, this is a less reliable permanent connection as external electrical noise can cause USB disconnection errors on a data logger.

For more information on making connections refer to Section 4.6.1.1.

Note: Only the Advanced protocol is supported for USB communication.

4.3 TCP/IP Network Communication (optional)

Instruments with the optional network port installed can be accessed using a TCP/IP connection. Figure 14 shows examples of some possible configurations for remote access.

Direct Connection

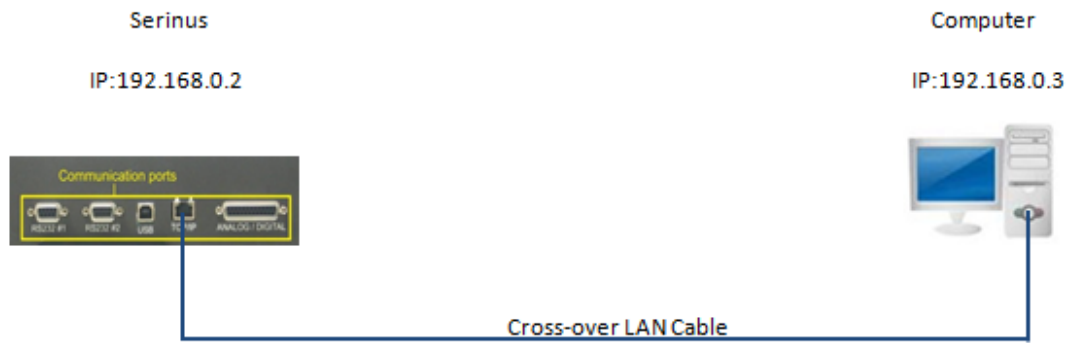

LAN

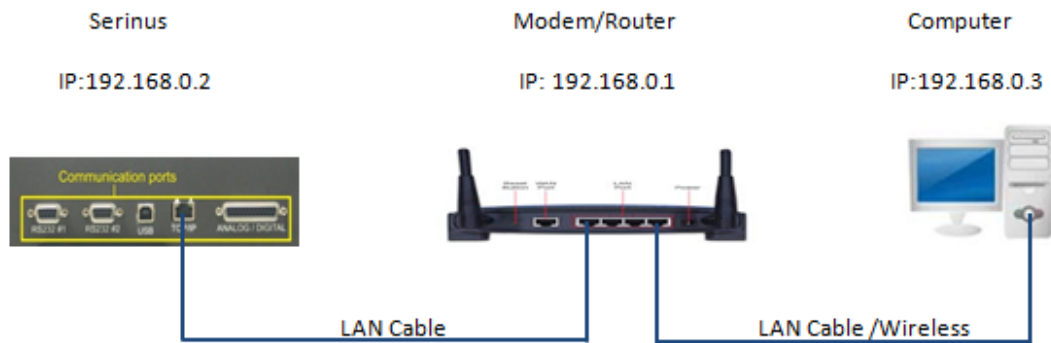

WAN

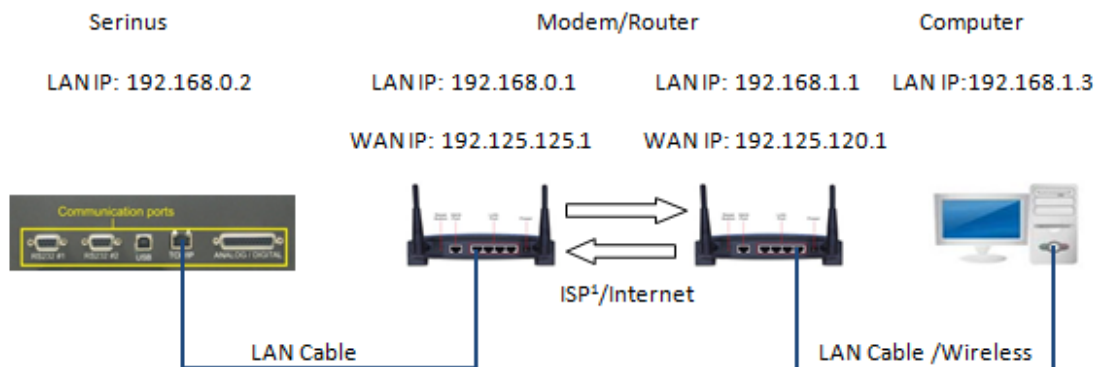

¹ ISP: Internet Service Provider

Figure 14 – Example of Typical Network Setups

Note: In Figure 14 all the IP addresses are taken as an example. The WAN IP addresses are normally provided by your ISP. Whereas, the LAN IP addresses can be set manually to any range which is within the subnet of the Modem/Router/switch.

Use a cross-over LAN cable to connect the instrument directly to a computer, or a standard LAN cable for connection to a Modem/Router/Switch as shown in Figure 14. The computer could be connected to the Modem/Router using either CAT5 cable or a wireless connection, but the instrument must be connected using CAT5/6 cable.

4.3.1 Reading Network Port Setup

To read the current network port settings perform the following steps:

Procedure

1. Open - **Main Menu** → **Communications Menu** → **Network Menu**.
2. Select - **Start-up Mode** → **Read IP** - Accept.
3. Manually use the power switch on the rear of the instrument to turn the power Off. Please leave the instrument off for 10 seconds before turning the power back On.
4. Open - **Main Menu** → **Communications Menu** → **Network Menu**.
5. The current network port settings will now be displayed on the screen.
6. When viewing is complete select - **Start-up Mode** → **Normal** - Accept.

4.3.2 Setting Network Port Setup

Below is an example of how to setup the network port.

Procedure

1. Open - **Main Menu** → **Communications Menu** → **Network Menu**.
2. Select - **Protocol** → **Advanced** - Accept.
3. Select - **Start-up Mode** → **Set IP** - Accept.
4. Edit - **IP Address** - (Change the IP address to the address you wish to use within the Modem/Router/switch subnet).
5. Edit - **Netmask** - (Change the Netmask to the setup specified by the Modem/Router).
6. Edit - **Gateway** - (Change the Gateway to the setup specified by the Modem/Router).

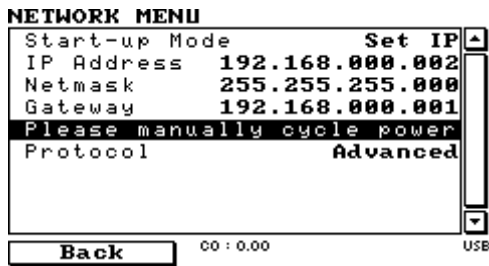

Figure 15 – Example of Network Menu Setup

- Once completed, use the power switch on the rear of the instrument to turn the power Off. Please leave the instrument off for 10 seconds before turning the power back On.

Note: Manually perform a hardware power cycle every time the IP address is changed for it to take effect.

- Open - **Main Menu → Communications Menu → Network Menu.**
- The **Start-up Mode** automatically changes to **Read IP** and the current network port settings will be displayed on the screen.
- When viewing is complete select - **Start-up Mode → Normal** - Accept.

4.3.3 Port Forwarding on Remote Modem/Router Setup

When using the network port to connect to the router / modem with NAT enabled, you will need to add IP mapping to ensure that data is forwarded through to the desired port. This is known as port forwarding. To set-up the port for the instrument, you will need to go into the modem/router configuration. Normally, you will see the port forwarding setup under Port Forwarding, NAT or Port Mapping menu. Below is an example port forwarding setup.

The default port for the Serinus range of instruments is **32783**. The destination address is the instrument IP address setup in the **Network Menu**.

Item	Protocol	Incoming Address	Incoming Port	Destination Address	Destination Port
1	tcp	0.0.0.0	32783 - 32783	192.168.0.2	32783 - 32783

Figure 16 – Port Forwarding Example

4.3.4 Airodis Setup to Communicate with Serinus

Below is an example of Airodis setup for a LAN network. Ensure the IP address is set to the same as on the instrument **Network Menu**.

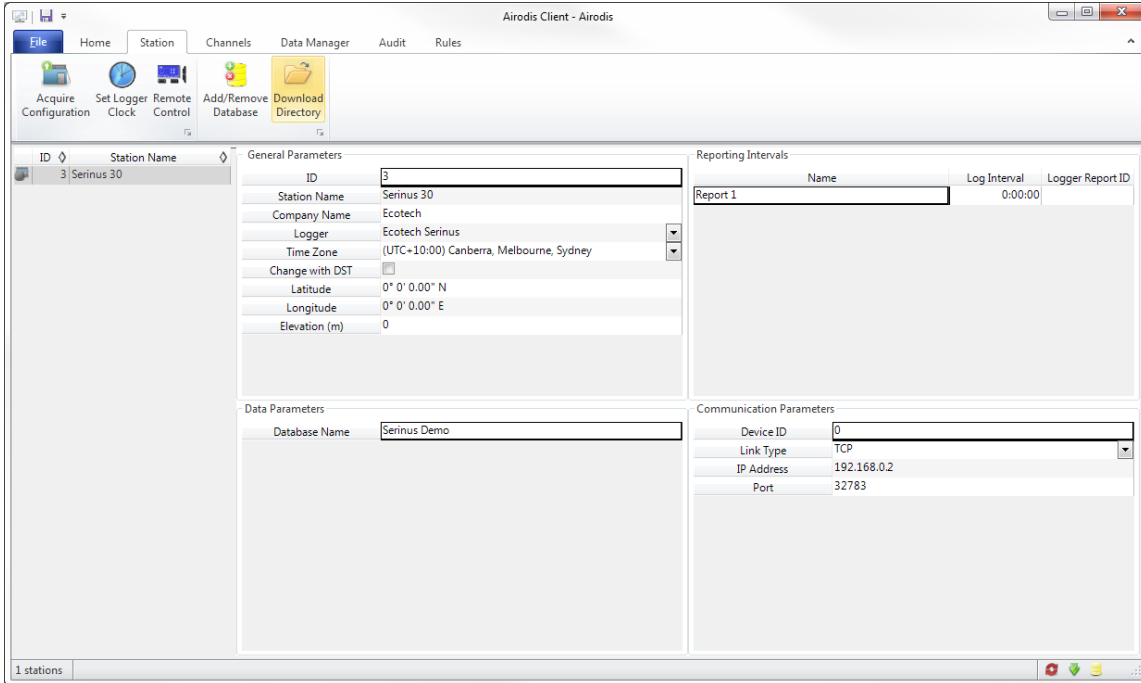

Figure 17 – LAN Network Set-Up (Airodis)

Below is an example of Airodis setup for a WAN network. Ensure the IP address is set the same as on the remote modem/router.

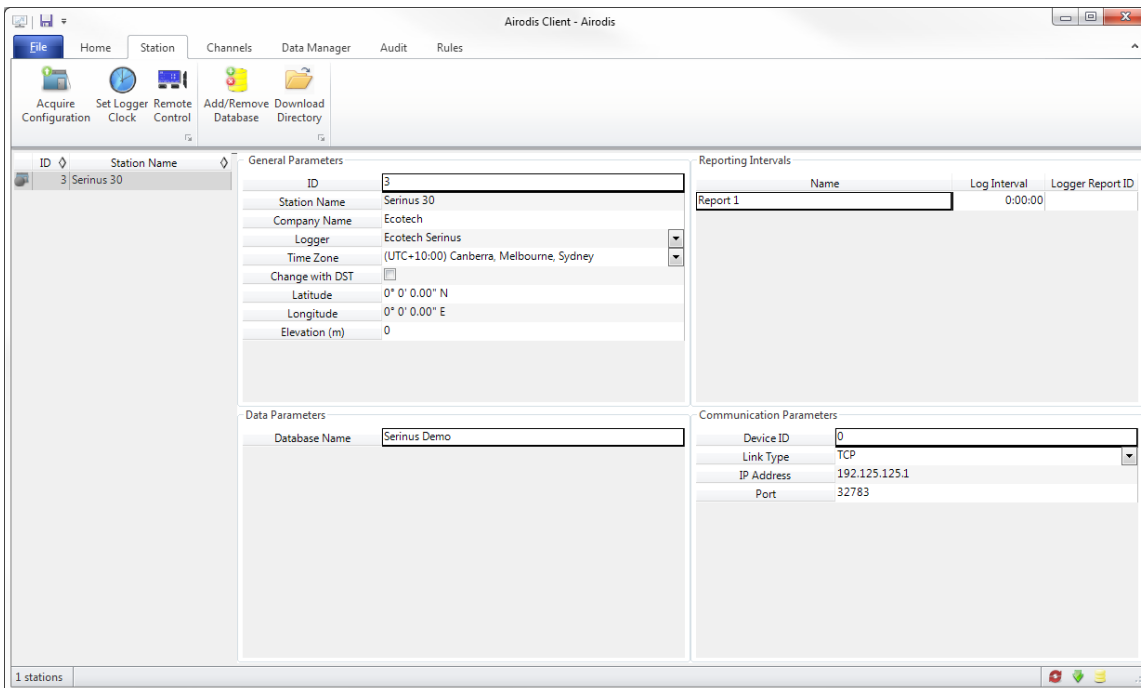

Figure 18 – WAN Network Set-Up (Airodis)

4.4 Analog and Digital Communication

The 25 Pin analog and digital I/O port on the rear of the instrument sends and receives analog and digital signals to other devices. These signals are commonly used to activate gas calibrators or for warning alarms.

4.4.1 Analog Outputs

The instrument is equipped with one to three analog outputs that can be set to provide either voltage (0-5 V) or current (0-20, 2-20 or 4-20 mA) output. The analog outputs are tied to specific instrument measurements, depending on the instrument type.

For 0-10 V analog output operation, set the output mode to current and move the jumpers (JP3) on the rear panel PCA to 0-10 V (refer to Figure 19). Ensure the Current Range is set to 0-20 mA to obtain the 0-10 V range. When calibrating the (current) analog output with the jumper set to 0-10 V, the 4 mA calibration target is now a 2 V target and 20 mA calibration target is now a 10 V target.

Table 4 – Analog Outputs

Analyser/Calibrator	Output 1	Output 2	Output 3
Serinus 10	O ₃	N/A	N/A
Serinus 30	CO	CO ₂ [optional]	N/A
Serinus 40	NO	NO _x	NO ₂
Serinus 44	NO	NH ₃	NO ₂
Serinus 50	SO ₂	N/A	N/A
Serinus 51	SO ₂	H ₂ S	N/A
Serinus 55	H ₂ S	N/A	N/A
Serinus 56	TS	N/A	N/A
Serinus 57	TRS	N/A	N/A
Serinus 60	NO ₂	N/A	N/A
Serinus Cal 3000	N/A	O ₃	N/A

4.4.1.1 Analog Outputs Voltage Calibration

Equipment Required

- Multimeter (set to volts)
- Male 25 pin connector with cable

Procedure

1. Open - **Main Menu** → **Communications Menu** → **Analog Output Menu** (refer to Section 3.4.26).
2. Select - **Output Mode** → **Voltage**.
3. Connect a multimeter (using an appropriate adaptor or probes on the multimeter) to the ground (pin 24) and the relevant output pin (pin 10).

4. Edit - **0.5V Calibration** - (until the multimeter reads $0.500\text{ V} \pm 0.002$) - Accept.
5. Edit - **5.0V Calibration** - (until the multimeter reads $5.00\text{ V} \pm 0.002$) - Accept.

4.4.1.2 Analog Outputs Current Calibration

Equipment Required

- Multimeter (set to mA)
- Male 25 pin connector with cable

Procedure

1. Open - **Main Menu** → **Communications Menu** → **Analog Output Menu** (refer to Section 3.4.26).
2. Select - **Output Mode** → **Current**.
3. Connect a multimeter (using an appropriate adaptor or probes on the multimeter) to the ground (pin 24) and the relevant output pin (pin 10).
4. Edit - **4mA Calibration** - (until the multimeter reads $4\text{ mA} \pm 0.01$) - Accept.
5. Edit - **20mA Calibration** - (until the multimeter reads $20\text{ mA} \pm 0.01$) - Accept.

4.4.2 Analog Inputs

The instrument is also equipped with three analog inputs with resolution of 15 bits plus polarity, accepting a voltage between 0-5 V. These go directly to the microprocessor and should be protected to ensure static/high voltage does damage the main controller PCA (instrument warranty does not cover damage from external inputs).

4.4.3 Digital Status Inputs

The instrument is equipped with eight logic level inputs for the external control of the instrument such as Zero or Span sequences. Each input has a terminating resistor which can be either PULL UP or PULL DOWN. This is set using the jumper JP1 on the back panel PCA (refer to Figure 19).

4.4.4 Digital Status Outputs

The instrument is equipped with eight open collector outputs which will convey instrument status condition warning alarms such as no flow, sample mode, etc. Two of the digital outputs can be set so that there is +5 V and +12 V available on the 25 pin connector for control purposes, instead of digital outputs 0 and 1.

In the default jumper locations (refer to Figure 19) these two outputs will function normally as open collector outputs. If moved to the position closer to the 25 pin connector then the DO 0 will supply +12 V and DO 1 will supply +5V.

The +12 V and +5 V supplies are limited to about 100 mA each.

Each digital output is limited to a maximum of 400 mA. The total combined currents should not exceed 2 A.

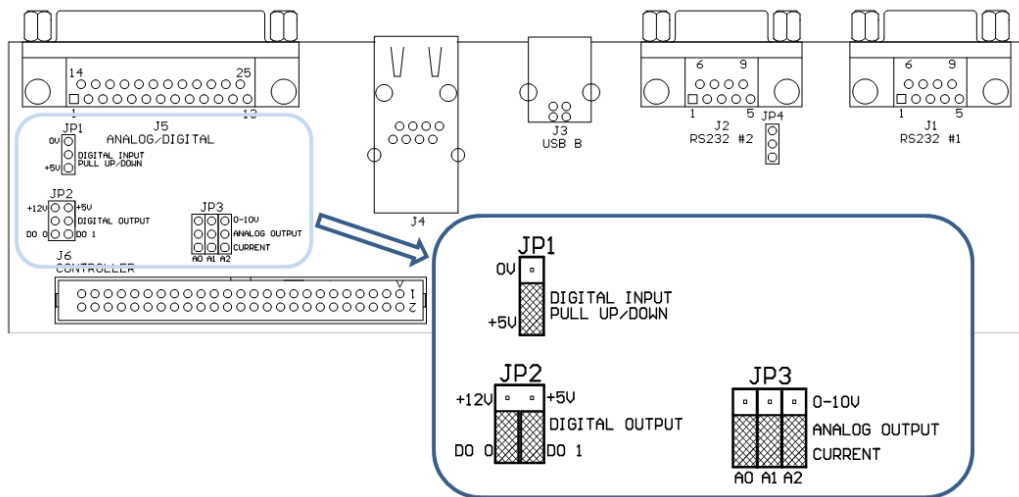

Figure 19 – 25 Pin Rear Panel PCA (Default Jumpers Highlighted)

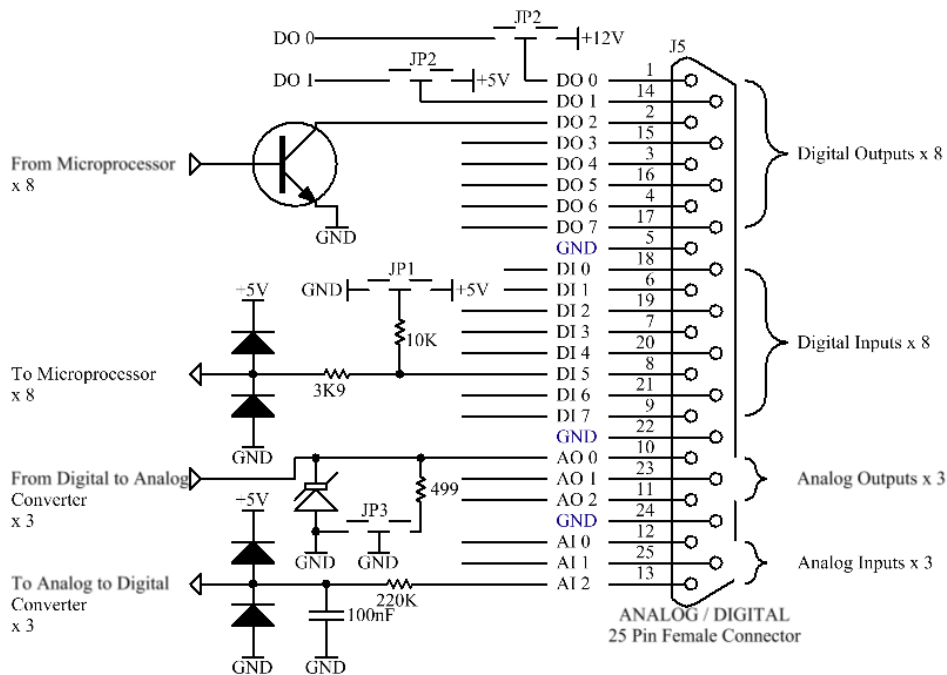

Figure 20 – External 25 Pin I/O Individual Pin Descriptions



CAUTION

The analog and digital inputs and outputs are rated to CAT I. Exceeding 12 VDC or drawing greater than 400 mA on a single output or a total greater than 2 A across the eight outputs can permanently damage the instrument and void the warranty.

4.5 Logging Data

When the user receives the instrument from the factory it will have a default set of parameters already setup in the internal data logger. These select few parameters have been chosen for their relevance in assisting in troubleshooting the instrument.

4.5.1 Configure Instrument Internal Logging

In order to log data you must first specify a data logging interval. This is how often data will be logged to the USB memory stick. You can log a maximum of 12 parameters. These parameters can be selected by name or by parameter number using the parameter list as a reference (refer to Table 25).

4.5.1.1 Data Log Setup –Numeric

Procedure

1. Open - **Main Menu** → **Communications Menu** → **Data Logging Menu** (refer to Section 3.4.23).
2. Select - **Data Log Interval** - (adjust to the desired value) - Accept.
3. Open - **Data Log Setup –Numeric** - (select the parameter numbers you wish to log).
4. Edit - (Change one of the storage locations “Parameter 1-12” to the parameter number you wish to log) - Accept

4.5.1.2 Data Log –Text

Procedure

1. Open - **Main Menu** → **Communications Menu** → **Data Logging Menu** (refer to Section 3.4.23).
2. Select - **Data Log Interval** - (adjust to the desired value) - Accept.
3. Open - **Data Log Setup –Text** - (select the names of the parameters you wish to log).
4. Select - (Change one of the storage locations “P1-P12” to the parameter text you wish to log) - Accept.

4.6 Using Airodis Software to Download Data

4.6.1 Connecting the Instrument to Your PC

The instrument can communicate with a PC using RS-232 (Serial), TCP/IP (Network), Bluetooth or USB. Serial, Bluetooth and network communications do not require additional drivers. If you wish to connect using a USB cable, the driver must first be installed.

4.6.1.1 Connecting Over USB

If you wish to connect using USB, you will need to first install the Serinus USB driver.

Power on the instrument and connect it to your PC with a USB cable. You should receive a prompt if the driver needs to be installed. If not, open Device Manager (Under “System” in Control Panel), find the device and select “Update Driver Software”.

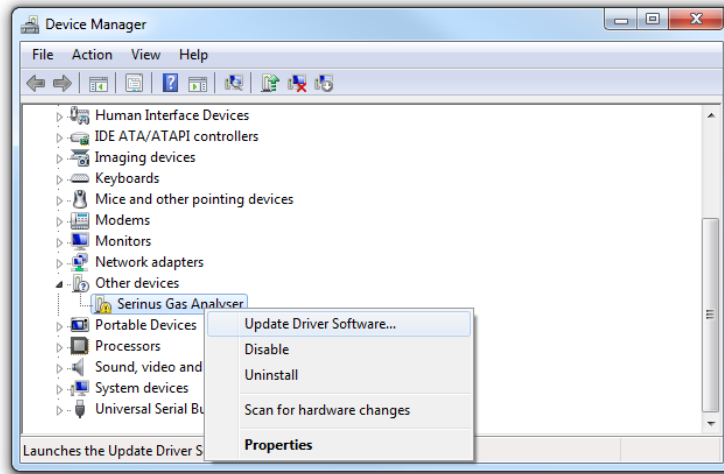

Figure 21 – Installing Driver Software (Device Manager)

When prompted where to search for the driver, select “Browse my computer for driver software”.

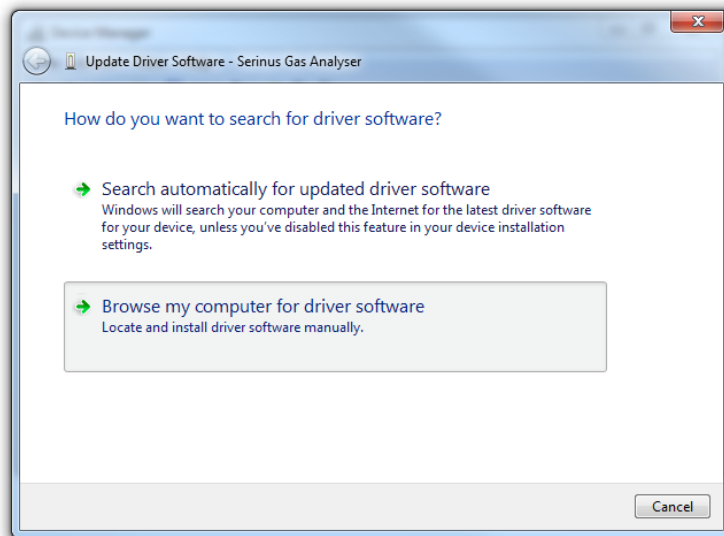

Figure 22 – Update Driver Popup

The Serinus USB driver is located on the green Ecotech resources USB stick under “\Drivers\Ecotech Analyser”. Select this directory and click **Next**.

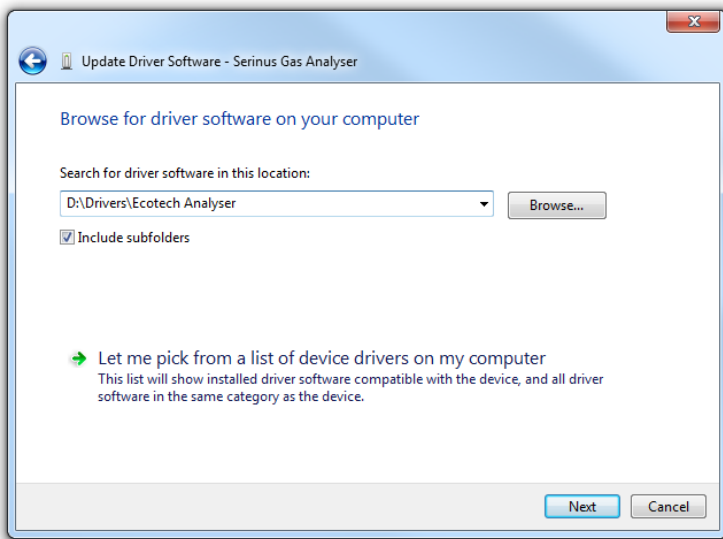

Figure 23 – Update Driver Popup (Directory Location)

If you receive a confirmation prompt to install the driver, select **Install**.

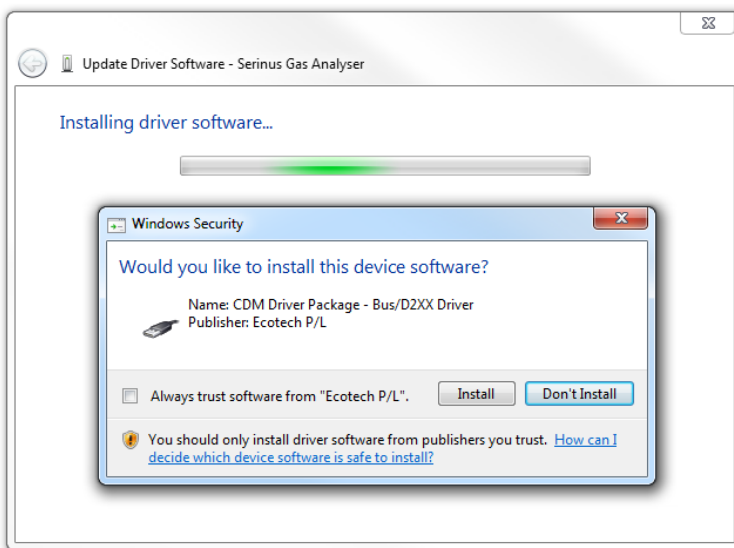

Figure 24 – Installing Driver Confirmation Prompt

If everything went smoothly, Windows will inform you that the driver was successfully installed.

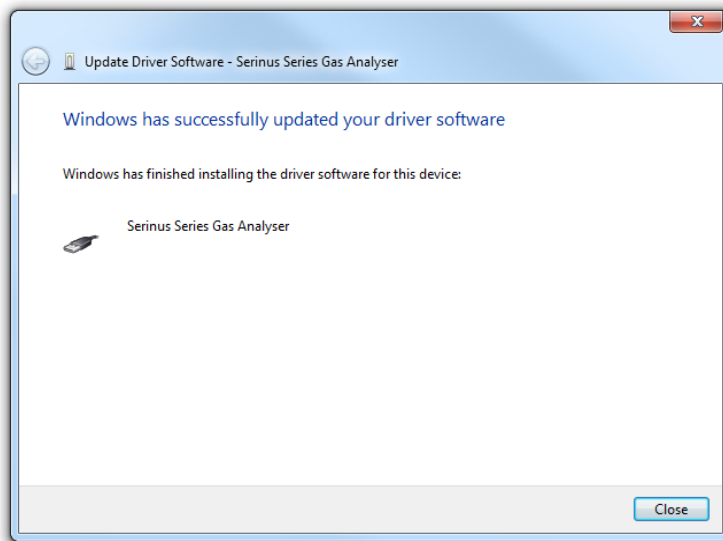

Figure 25 – Successful Driver Installation

4.6.1.2 Connecting Over Serial (RS-232)

The following steps outline how to setup the instrument for connection to a PC or datalogger (refer to Section 3.4.24).

Procedure

1. Open - **Main Menu** → **Communication Menu** → **Serial Communication Menu**.
2. Determine which RS232 Port you are physically making the connection with. Remember, multidrop is only supported on RS232 #2.
3. Select - **Baudrate** → **38400** - Accept (Set an appropriate baud rate, default is 38400).
4. Select - **Protocol** → **Advanced** - Accept.

If you are running Airodis in a multidrop configuration, ensure that the **Serial ID** is unique for each instrument on the chain.

4.6.1.3 Connecting Over Network (TCP/IP)

The following steps outline how to setup the instrument for connection to a PC or datalogger (refer to Section 3.4.29).

Procedure

1. Open - **Main Menu** → **Communication Menu** → **Network Menu**.
2. Select - **Protocol** → **Advanced** - Accept.
3. Select - **Start-up Mode** → **Set IP** - Accept.
4. Assign a unique static IP address to the instrument.
5. Reboot the instrument by cycling the power.

4.6.2 Installing Airodis

The user can download data from the instrument using either a full retail (paid) version of Airodis or with the demo version which is included on the green Ecotech resources USB stick. The demo version has limited functionality, but will allow you to download and export data from up to three instruments. If you do not already have Airodis, this can be obtained from Ecotech:

<http://www.airodis.com.au>

The installer is straightforward: Ensure you install the correct version for your operating system. If you are running 64-bit windows, install the 64-bit (x64) version. Otherwise, install the 32-bit (x86) version.

4.6.3 Configuring Airodis

1. Once installed, double click on the Airodis shortcut on the desktop to start Airodis Workspace Manager. You will be presented with the default workspace options. These will suffice for downloading data from the instrument.

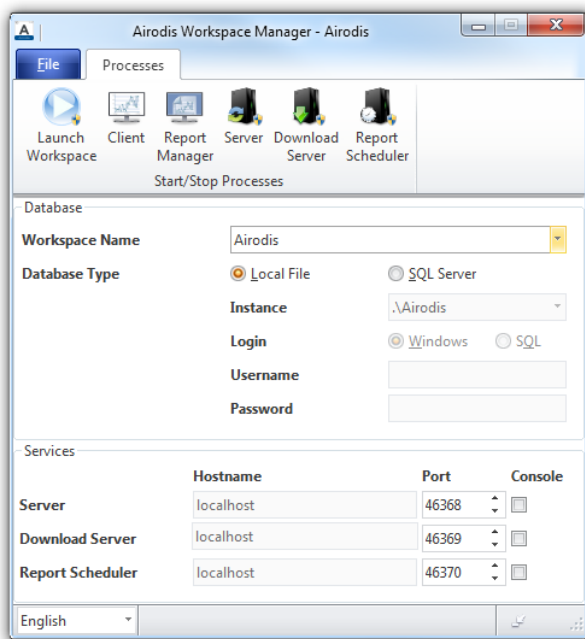

Figure 26 – Airodis Workspace Manager

2. Start the Client, Server and Download Server by single-clicking the toggle button for each. The client may prompt to register with Ecotech or install an update. Follow the prompts if it does.
3. Once the Client application has loaded, click **Home** → **Add Station** → **New Physical Station**.

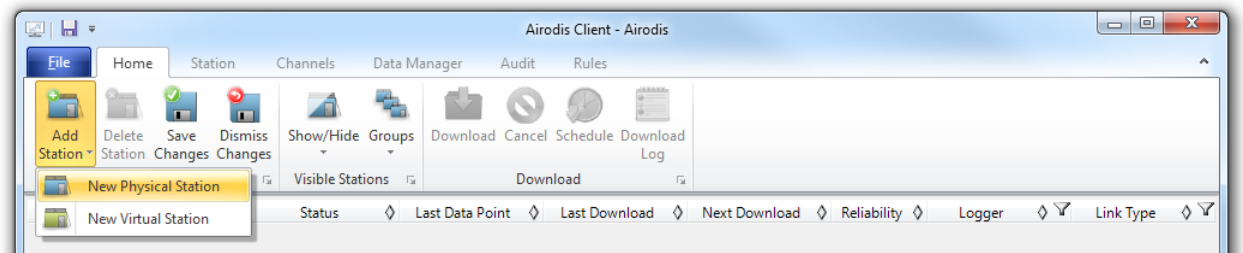

Figure 27 – Adding a New Station

- This automatically brings you to the **Station** tab on the ribbon. Enter the communication details to connect to the instrument.

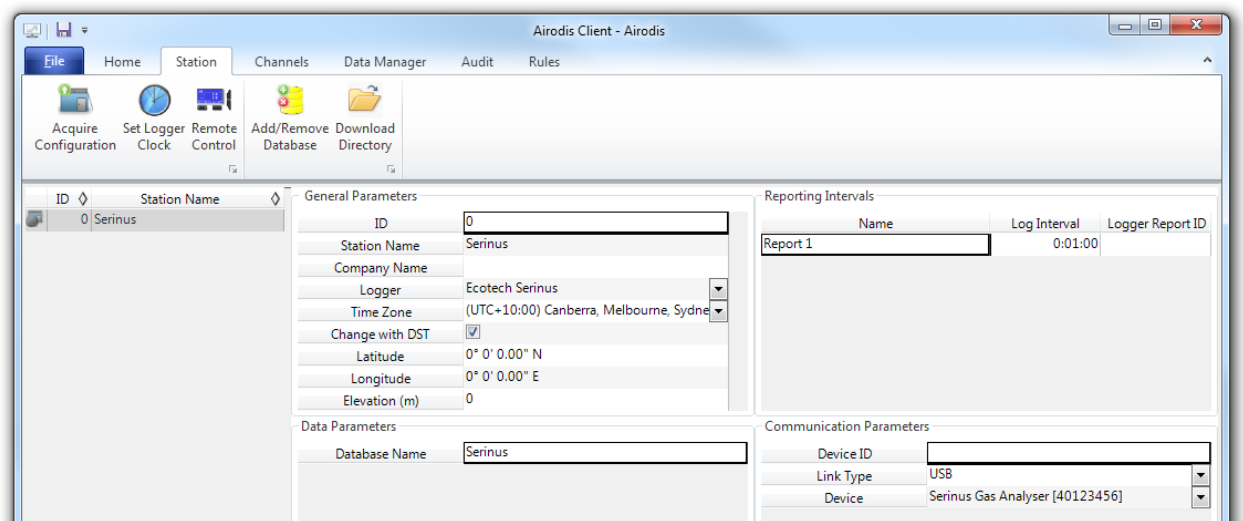

Figure 28 – New Station Connection

Table 5 – New Station Setup

Property	Description
Station Name	The name of the station. If you have other loggers, the name is used to distinguish them.
Logger	Set this to “Ecotech Serinus” when downloading from any Serinus series instrument. This will communicate with the instrument via the Advanced protocol. If using a network or serial connection, ensure that the Advanced protocol has also been selected on the instrument itself.
Time Zone	Set this to the time zone that the instrument is located in.
DST	Enable this option if you plan on changing the clock on the instrument with daylight savings. Leave this disabled if the clock does not shift during DST. The instrument will need to be adjusted manually for DST – it will not happen automatically.
Database Name	This is the name to be used for the table in the SQL database containing this station’s data. It must be unique for each station.
Device ID	Enter the Serial ID of the instrument. If you are not using multidrop; this can be set to “0” or left blank.

Property	Description
Link Type	Select the type of connection used to connect to the instrument. Different properties will appear depending on the link type selected. Align these settings with those of the instrument.
Log Interval	This needs to be the same as the Data Log Interval setting on the instrument.

Note: The available fields for communication parameters will change when you change the link type. You will need to set the communication parameters that have been defined on the instrument.

- Once the station has been created, save the station by clicking the Save shortcut icon or **File → Save**.
- Click Acquire Configuration. This will probe the instrument for a channel list. After a few seconds, the channel list should be visible in the **Channels** tab.

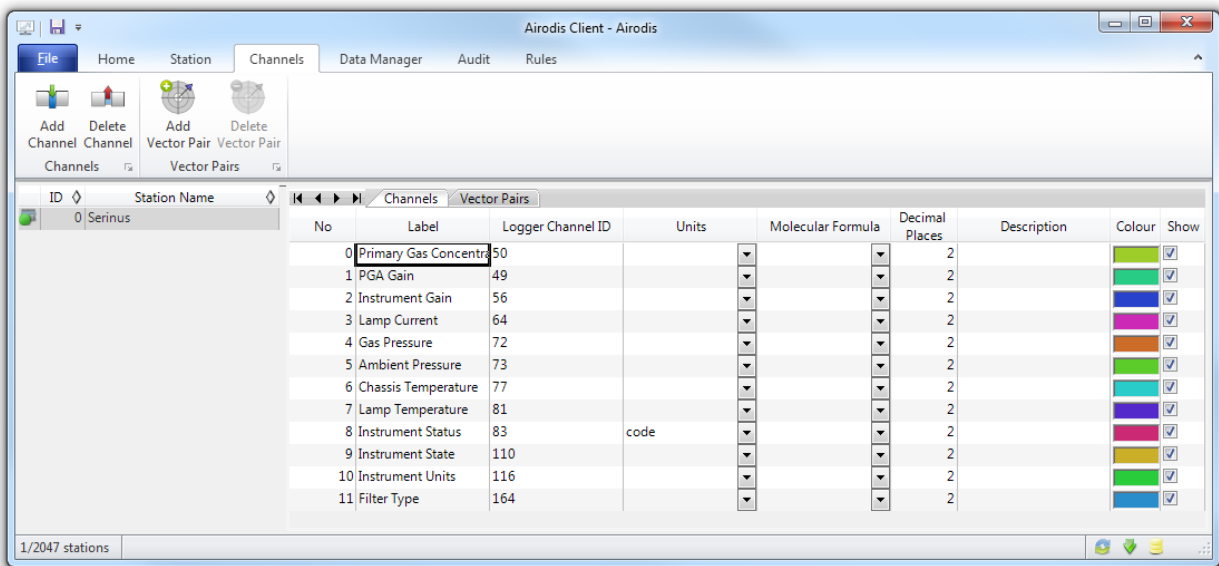

Figure 29 – Station Configuration (Channel List)

Note: If there was an error connecting to the instrument, a red dot will appear next to the station name in the station list (on the far left hand side). Hovering over the red dot will present you with an error message (refer to Figure 30).

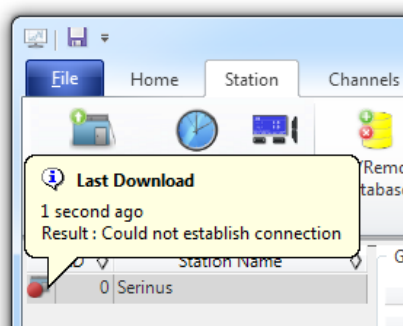

Figure 30 – Error Status Notification

7. Select the Data Manager tab, click download. The Download Data window will appear. Select the appropriate time period that you wish to download and click Download.

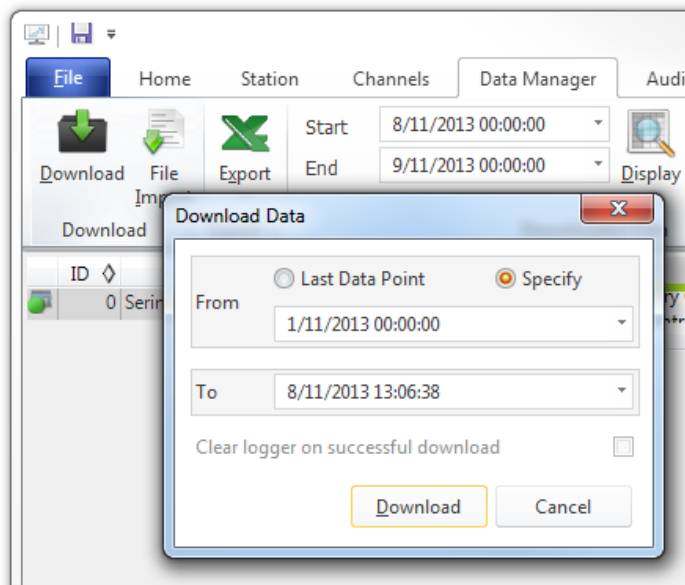

Figure 31 – Downloading Data

8. The status of the download will appear in the bottom-left corner of the window. You can also monitor the status of the download from the Home tab.

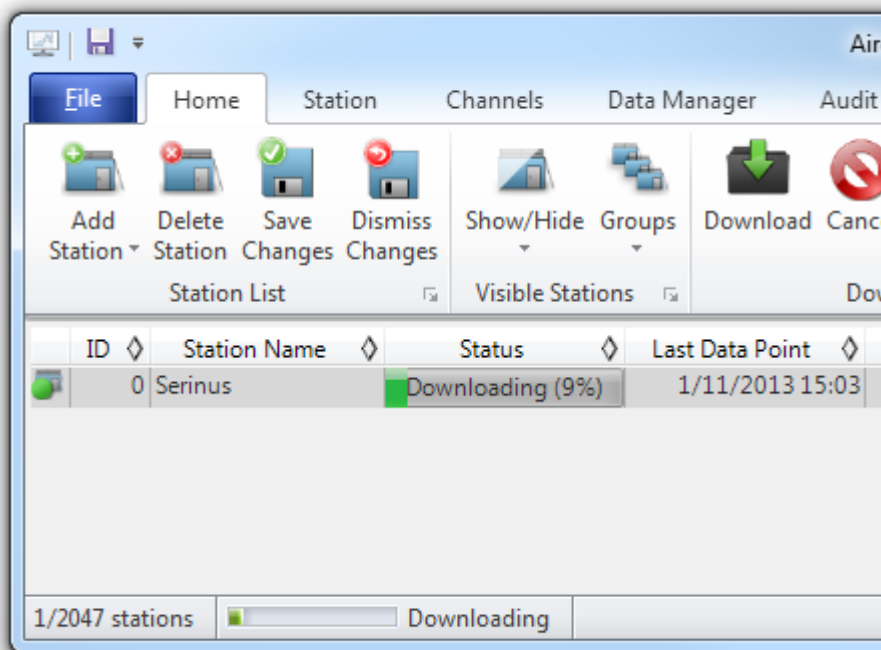

Figure 32 – Download Data Status

9. Data will become available in the data manager as it is downloaded. You can load data for a date range by entering the start and end dates and clicking **Display**. The selected data will be loaded into the data manager.

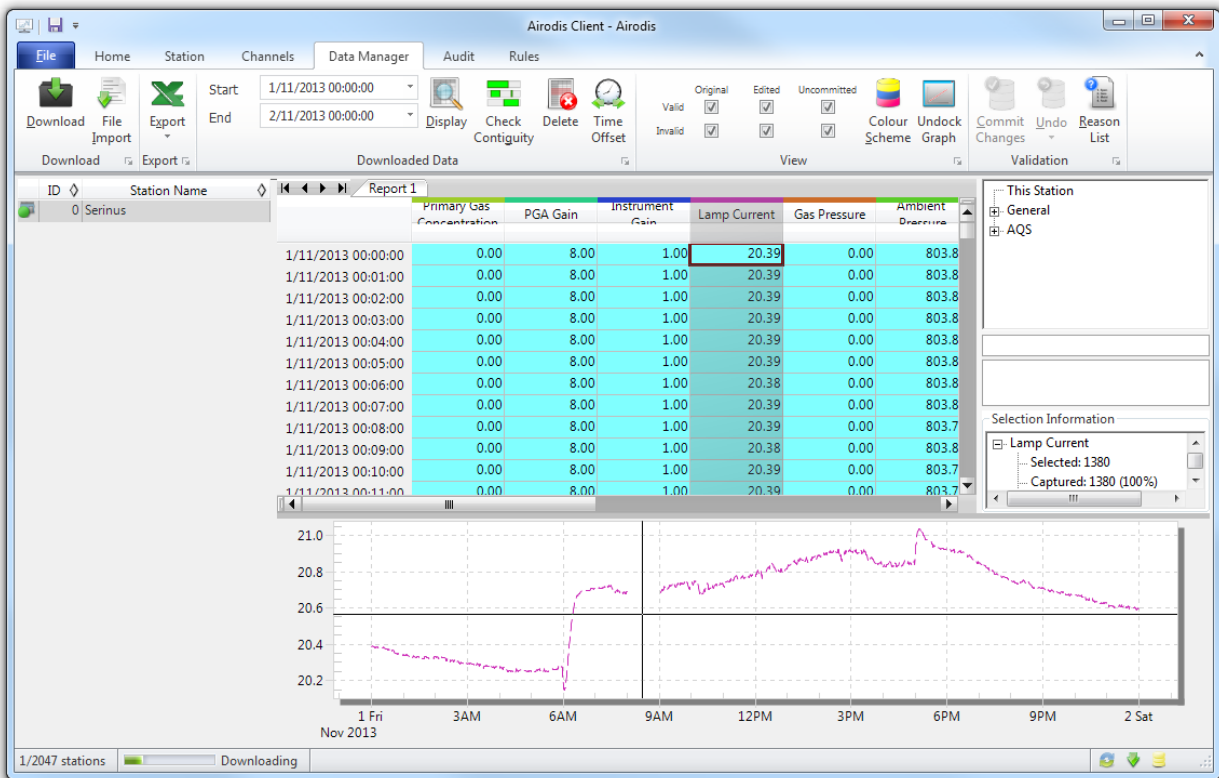

Figure 33 – Data Visibility

10. Data can be exported by clicking the Export function. This will allow you to save your data in CSV format, which can be loaded into another program such as Microsoft Excel. It is also possible to copy/paste (Ctrl + C / Ctrl + V) data directly from the Airodis data manager.

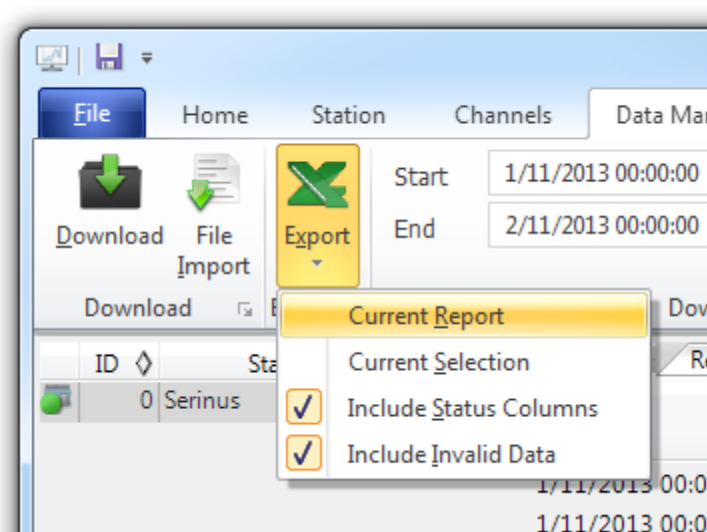
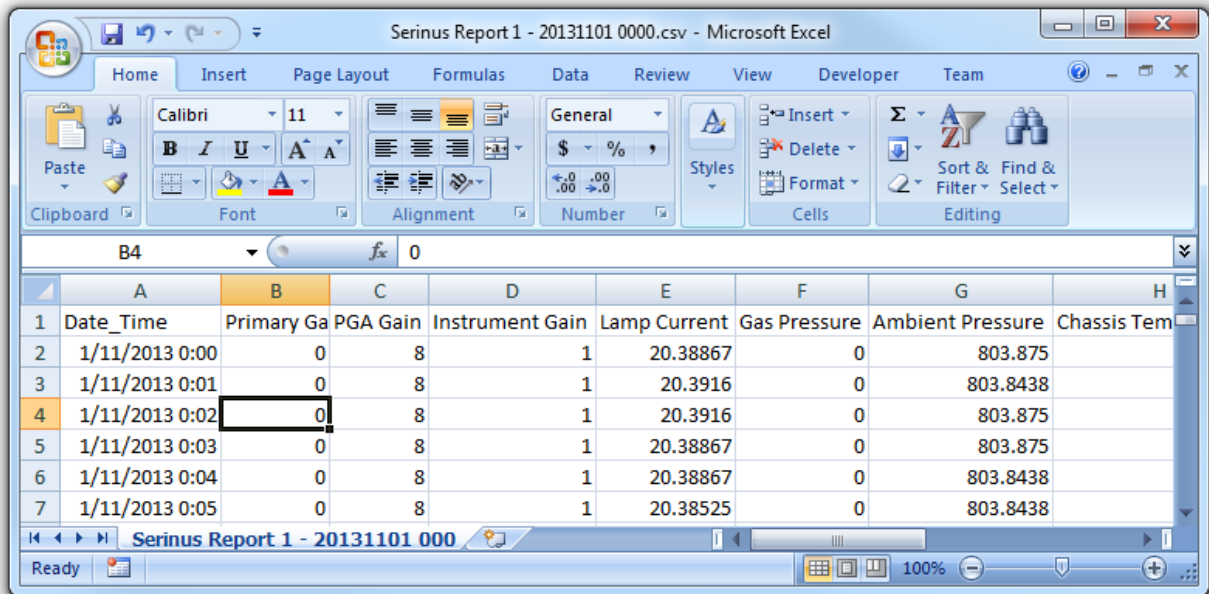

Figure 34 – Exporting Data

11. That's it! The data has been downloaded from the instrument and exported to a standard CSV file.



	A	B	C	D	E	F	G	H
1	Date_Time	Primary Ga	PGA Gain	Instrument Gain	Lamp Current	Gas Pressure	Ambient Pressure	Chassis Tem
2	1/11/2013 0:00	0	8	1	20.38867	0	803.875	
3	1/11/2013 0:01	0	8	1	20.3916	0	803.8438	
4	1/11/2013 0:02	0	8	1	20.3916	0	803.875	
5	1/11/2013 0:03	0	8	1	20.38867	0	803.875	
6	1/11/2013 0:04	0	8	1	20.38867	0	803.8438	
7	1/11/2013 0:05	0	8	1	20.38525	0	803.8438	

Figure 35 – Data Download Complete

4.7 Serinus Remote App/Bluetooth

The Serinus Remote Application allows for any Android device (Tablet or Smartphone) to connect to an instrument.

The Serinus Remote Application allows the user to:

- Completely control the instrument using a remote screen displayed on the device.
- Download logged data and take snapshots of all the instrument parameters.
- Construct graphs from logged data or real time measurements.

The following sections cover installation, connection and use of the application.

4.7.1 Installation

The Serinus Remote Application can be found in the Google Play Store by searching for Ecotech or Serinus. Once found, choose to **Install** the application and **Open** to start the application.

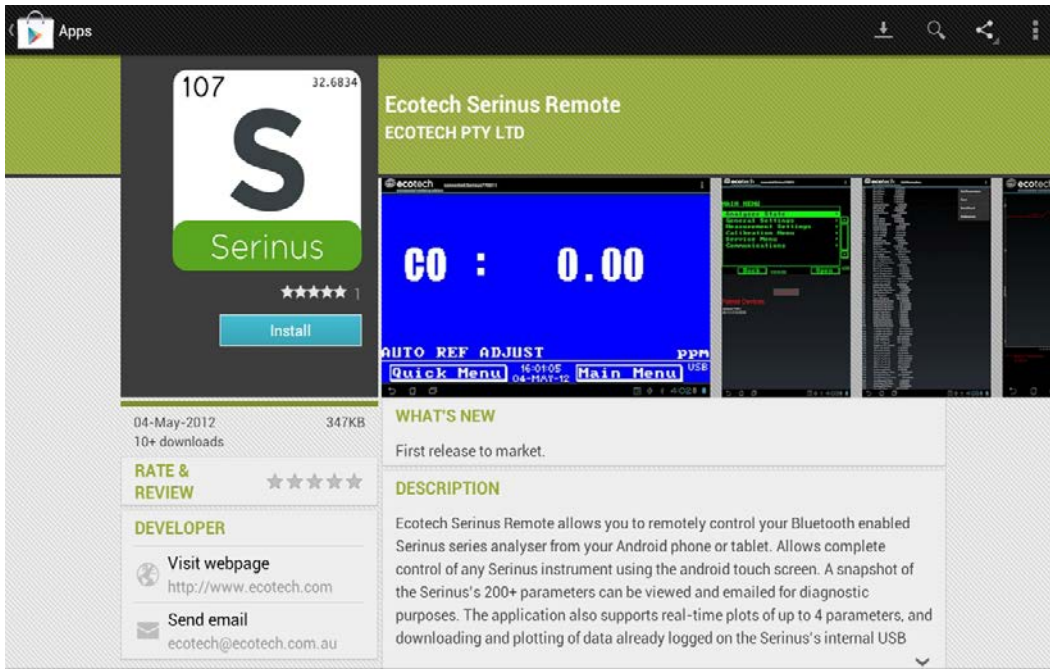

Figure 36 – Downloading the App From Google Play Store

Note: A menu containing additional features and functions can be accessed by entering the **Options Menu** (or similar) on your device. The location and format of this menu may vary.

4.7.2 Connecting to the Instrument

Procedure

1. Open - **Main Menu** → **Communications Menu** → **Bluetooth Menu** (to find the Bluetooth ID and PIN) (refer to Section 3.4.30).
2. Touch the Scan Serinus Analysers button at the bottom of the screen.
3. Select the Analyser ID from either the Paired Devices or the Other Available.
4. Input the PIN (if prompted) and press OK (refer to Section 3.4.30).

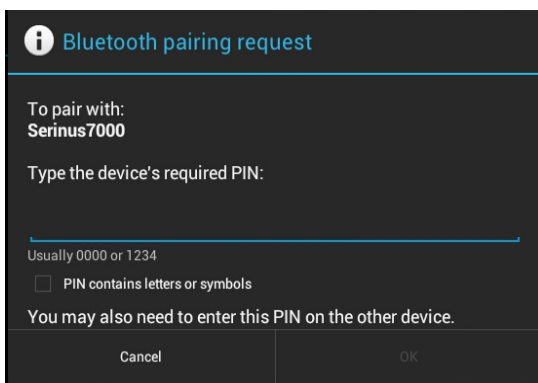

Figure 37 – Bluetooth Pairing Request

5. A screen shot of the instrument's current screen should appear on your Smartphone or tablet. To disconnect press the back key/button on the device.

Note: Once the instrument has been paired with the device it will appear under “Paired Devices” and the PIN will not need to be entered again. Only one Bluetooth connection can be made to an instrument at any one time.

4.7.3 Instrument Control

Once connected the user has full control of the instrument. The range for remote control depends on the device’s Bluetooth capabilities and any intervening obstructions, but is usually up to 30 meters.

Remote Screen Operation

With the exception of the number pad, all button functions/actions can be performed by touching the screen. This includes the selection buttons and the scroll buttons. Touching any part of the screen where there is not already a button also enacts the functions of the scroll buttons.

Home Screen

Touching the upper half of the screen increases the contrast and touching the lower half of the screen decreases contrast on the real instrument.

Menus

Touching the upper or lower half of the screen allows the user to scroll up and down respectively.

Right-hand Section of the Screen

Swiping from right to left brings up the number pad for entering numbers (swipe from left to right to hide the number pad).



Figure 38 – Showing or Hiding the NumPad

Left-hand Section of the Screen

Swiping from left to right brings up a list of available analysers (swipe from right to left to hide the instrument list).

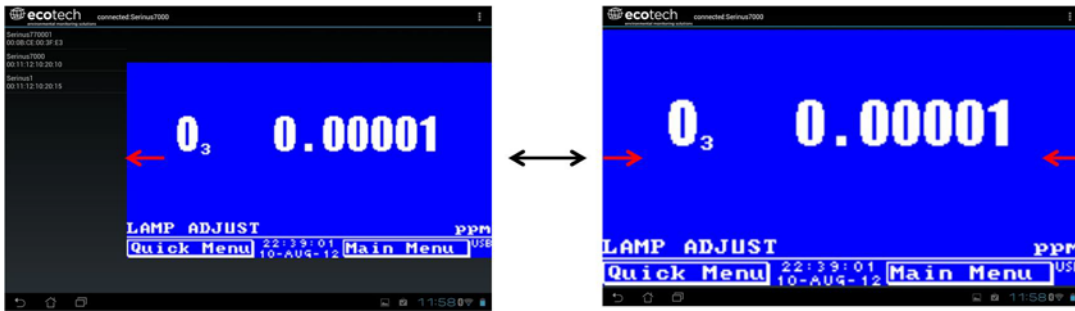

Figure 39 – Switching Analysers

Back Button

This button will enable the user to return to the selection screen, allowing connection to a different instrument.

Options Menu

The Options Menu is accessed by the grey button in the top right corner of the screen or pressing the Menu Button, depending on your Android device.

Refresh	Refresh the display.
Show/Hide NumPad	Show or hide the number pad.
Real Time Plot	Refer to Section 4.7.4.
Download	Refer to Section 4.7.5.
Get Parameters	Refer to Section 4.7.6.
Preferences	Refer to Section 4.7.7.

4.7.4 Real-Time Plot

Allows the user to view real-time plotting of up to four parameters at the same time. The user can also scroll from left to right, top to bottom or zoom in and out on the plot by swiping/pinching.

Once the plot is zoomed or scrolled, it enters into Observer Mode, meaning that auto-scaling is suspended. Press at the top of the screen (where it says Observer Mode) to return to Normal Mode.

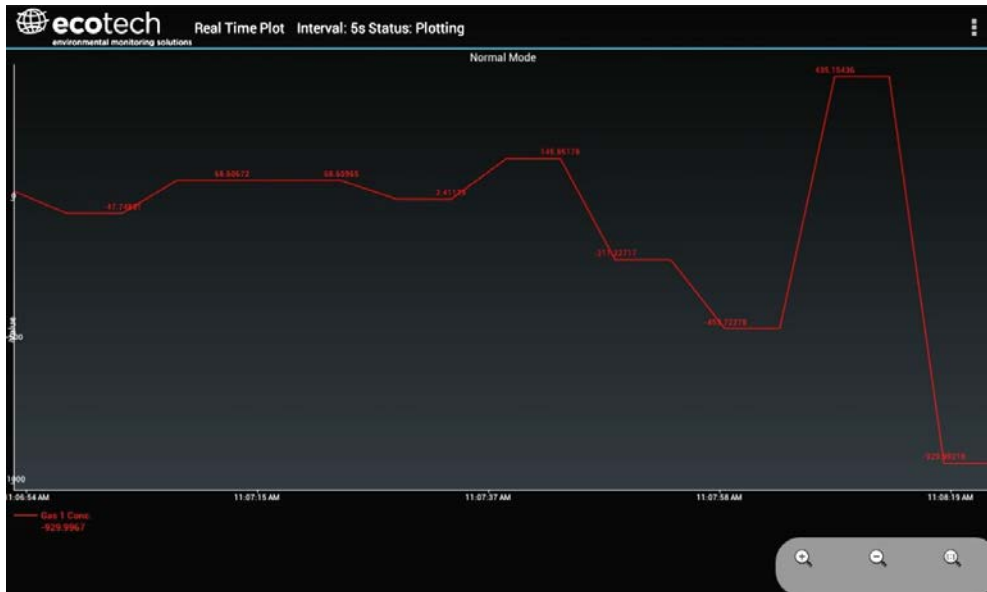

Figure 40 – Real-Time Plot

Options Menu

The Options Menu is accessed by the grey button in the top right corner of the screen or pressing the menu button, depending on the Android device.

Start	Restarts graphing if it has been stopped and returns the graph to Normal Mode .
Stop	Stops collecting data. In this mode you can scroll the display without going into Observer Mode , because the system has no data collection to suspend. It is necessary to “Stop” data collection to set the interval.
Clear	Clears the window and restarts the graphing.
Save	Saves an image of the graph and accompanying data in the location specified in preferences (refer to Section 4.7.7). The user will also be asked whether they want to send the file and data via email. When saving the data, you can choose to Save All Data or Customise the length of the data by entering a time between five minutes and six hours. Only the data from the start of collection to that limit will be saved (although the plot will still appear exactly as it does on the screen).
Set Interval	While data collection is stopped, the user can specify the time intervals between collections.

4.7.5 Download

Download logged data from the USB memory stick inside the instrument. All data logged by the instrument to the USB memory stick over the period of time specified will be collected. Due to the slow connection speed of Bluetooth, this should only be used for relatively short sections of data. Downloading one days’ worth of one minute data is likely to take a couple of minutes.

Options Menu

Save	Generates a filename based on the start and end date/time specified. It saves the downloaded data in the location specified in preferences and asks to send the saved comma separated text file (.csv) as an attachment to an email. This file format does not include the parameter headings, just the values.
-------------	---

Send E-Mail	Sends an email with the parameter data in the body of the email, formatted as displayed (this includes the parameter name and the values).
Plot	Graphs the data that has been downloaded. The user is prompted to select which parameters to plot based on the parameters that were being logged (refer to Figure 41).
Preferences	Refer to Section 4.7.7.



Figure 41 – Plot of Downloaded Data

4.7.6 Get Parameters

Download a list of parameters and corresponding values directly from the instrument. This list of parameters is a snap shot of the current instrument state and is very helpful in diagnosing any problems with the instrument.

Options Menu

Get Parameters	Refreshes the parameter list display.
Save	Generates a filename from the current date and time, saves the parameter data in the location specified in preferences and asks to send the saved text file as an attachment to an email.
Send E-Mail	Sends an email with the parameter data in the body of the email, formatted as displayed.
Preferences	Refer to Section 4.7.7.

4.7.7 Preferences

The Preferences Menu allows the user to adjust the directory settings, logged data format and the colour scheme settings. It can be accessed through the **Options Menu** in most windows.

Directory Settings

The operator can specify/select where to save the parameter lists, logged data and real time plots.

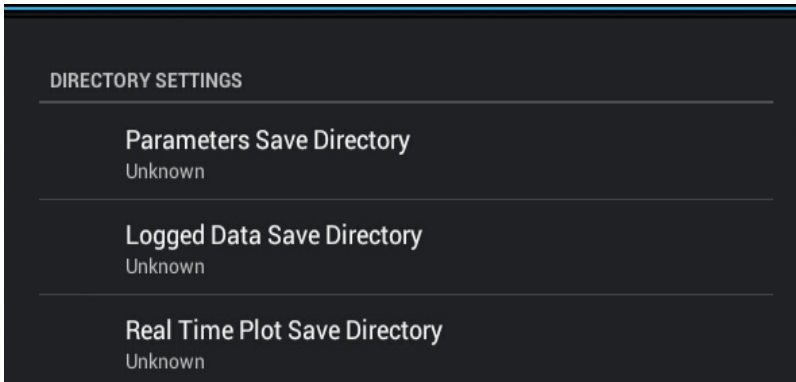

Figure 42 – Directory Settings

Logs Format

When downloading logged data, the parameters can be displayed on one line or each parameter on a separate line.

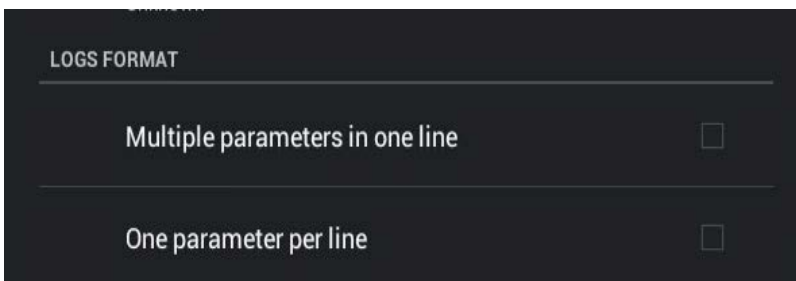

Figure 43 – Logs Format

Colour Theme Settings

Allows the user to choose a colour scheme for the remote screen: Matrix, Classic, Emacs or Custom.

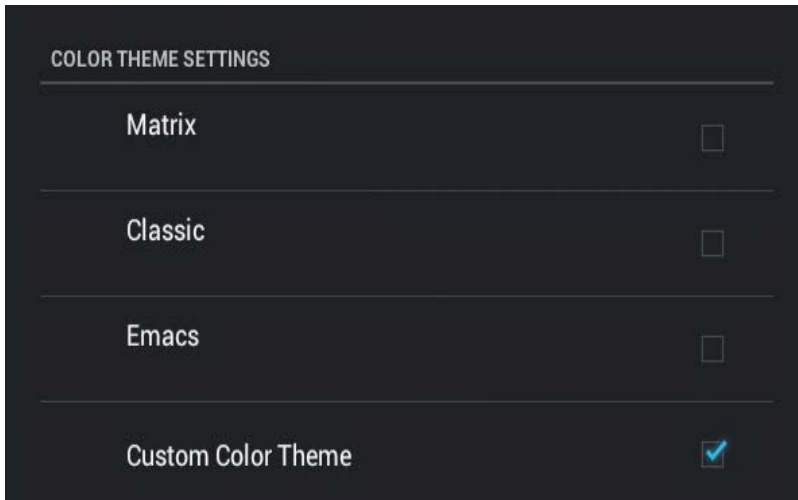

Figure 44 – Colour Theme Settings

5. Calibration

The following sections describe how to calibrate the span and zero points of the instrument as well as giving a brief overview of the calibration system.

Main Menu → Calibration Menu (refer to Section 3.4.10 for information on menu items).

5.1 Overview

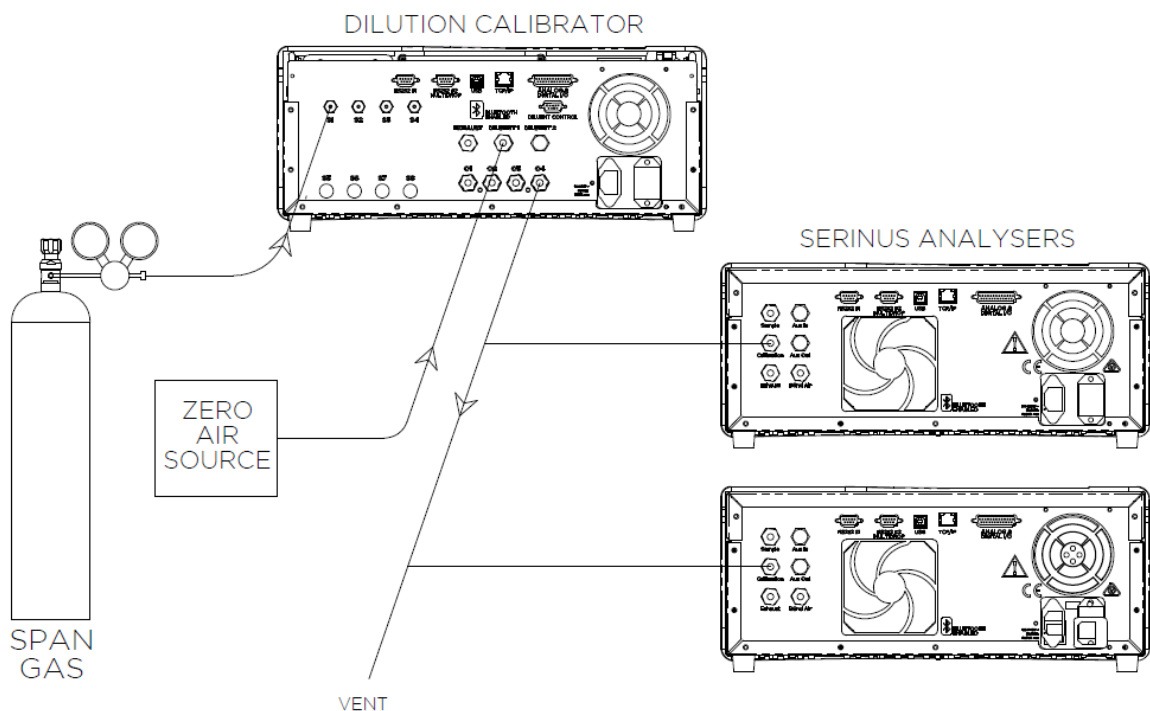

Figure 45 – Example of a Calibration System



CAUTION

All calibration gases **must** be supplied at ambient pressure to avoid damaging the instrument. If direct gas cylinder connection is required, high pressure Span/Zero options can be installed at time of ordering.

The calibration chapter consists of a:

- General discussion of calibration.
- Description of the pressure calibration procedure.
- Description of the Zero/Span precision check and calibration procedures.
- Description of the multipoint precision check procedure.

The Serinus 30 analyser is a precision measuring device which must be calibrated against a known source of CO (e.g. a certified gas cylinder).

There are several different types of checks/calibrations performed:

- Level 1 Calibration – A simplified two-point instrument calibration used when instrument linearity does not need to be checked or verified. This check is typically performed on a monthly basis. Adjustments to the instrument response can only be made when performing level 1 calibration.
- Level 2 Calibration – A simple check of the instrument's response. Level 2 checks may be performed using non-certified reference sources and are most often used as a performance monitoring tool. The instrument may not be adjusted
- Multipoint precision check – A series of calibration points, typically covering zero and 5 up-scale points, measured using a certified reference atmosphere and covering the instruments FS measurement range. These precision checks are used to determine the linearity of the instrument response across its measurement range.

In general terms, the calibration process includes the following steps:

1. Establish a reliable and stable calibration source.
2. Provide a satisfactory connection between the calibration source and the instrument.
3. Calibrate the instrument against the calibration source.

Multipoint precision check is used to establish the relationship between instrument response and pollutant concentration over the instrument's full scale range. Zero and span calibrations are frequently used to provide a two-point calibration or an indication of instrument stability and function.

Note: Zero calibrations are not recommended by Ecotech, but may be performed when specifically required by a user. Zero calibrations tend to mask issues that should be addressed during maintenance/service.

Regulations generally require that the instrument be span calibrated any time:

- The instrument is moved.
- The instrument is serviced.
- When changing the instruments units between volumetric and gravimetric.
- Whenever the instrument characteristics may have changed.

Regulatory agencies establish the time intervals at which the instrument must be calibrated to ensure satisfactory data for their purposes.

Note: Use of the Serinus 30 analyser as a U.S. EPA or EN-designated equivalent method requires periodic multipoint precision checks in accordance with the procedure described below. In addition, the instrument must be set to the parameters indicated in U.S. EPA (refer to Section 2.4) or EN Equivalent Set-up (refer to Section 2.5).

5.2 Pressure Calibration

The pressure sensors are a vital component of the instrument operation. The pressure calibration should be checked on installation or whenever maintenance is performed.

A thorough leak check must be performed prior to performing a pressure calibration (refer to Section 6.3.4).

The pressure calibration can either be a two point calibration (one point under vacuum and the other at ambient pressure) or a single ambient point calibration (when very minor adjustments are required).

Note: Ensure that the instrument has been running for at least one hour before any calibration is performed to ensure the instrument's stability. When performing a two point pressure calibration, it is advisable to perform the vacuum pressure calibration first.

5.2.1 Full Pressure Calibration

This section outlines how to perform a full pressure calibration. Using the required equipment follow the steps below to complete a full pressure calibration.

Note: Ensure that the instrument has been running for at least one hour before the calibration is performed.

Note: Ensure units of measure are the same on both the barometer and instrument.

Equipment Required

- Barometer
- Vacuum source

Procedure

1. Turn off the vacuum source and allow the instrument to return to ambient pressure.
2. Disconnect any external tubing connected to the rear of the instrument.
3. Open - **Main Menu** → **Calibration Menu** → **Pressure Calibration Menu** - (read note) - OK.

Note: This action will place the valve sequencing on hold; normal sampling will be interrupted.

4. Edit - **Vacuum Set Pt.** - (Read displayed instructions) - OK.
5. Connect a barometer to the **Sample Port** (refer to Figure 6).
6. Connect a vacuum source to **Exhaust Port** (refer to Figure 6) of instrument.
7. Wait 2-5 minutes and ensure the pressure reading on the barometer has dropped and is stable.
8. Enter the barometer reading into the instrument - Accept.
9. Read displayed instructions - OK.

10. Turn off the vacuum source and wait 1 min or until the barometer reads ambient. Disconnect the vacuum source and barometer from **Exhaust Port** and **Sample Port**.
11. Wait 2-5 min, enter the ambient barometer reading into the instrument - Accept.

Note: Both cell and ambient pressure sensors should now be displaying the current ambient pressure and they should be the same value within 3 torr of each other.

12. Back - **Pressure Calibration Menu** - (read note) - OK.

5.2.2 Ambient Point Pressure Calibration

Full pressure calibrations are generally recommended, however it is possible to calibrate only the ambient point in cases where only a minor ambient pressure adjustment is required.

Note: Ensure that the instrument has been running for at least one hour before any calibration is performed to ensure the instrument's stability.

Note: Ensure units of measure are the same on both the barometer and instrument.

Equipment Required

- Barometer

Procedure

1. Turn off the vacuum source and allow the instrument to return to ambient pressure.
2. Disconnect any external tubing connected to the rear of the instrument.
3. Open - **Main Menu** → **Calibration Menu** → **Pressure Calibration Menu** - (read note) - OK.

Note: This action will place the valve sequence on hold; normal sampling will be interrupted.

4. Edit - **Ambient Set Pt.** - (Read displayed instructions) - OK.
5. Disconnect any external tubing connected to the rear ports of the instrument (**Sample Port**, **Exhaust Port**, etc).
6. Wait 2-5 minutes and enter the ambient barometer reading into the instrument - Accept.

Note: Both cell and ambient pressure sensors should now be displaying the current ambient pressure and they should be the same value within 3 torr of each other.

7. Back - **Pressure Calibration Menu** - (read note) - OK.

5.3 Pressure Calibration (Internal Pump Option Only)

The internal pump requires a separate pressure calibration procedure that replaces the one used in Section 5.2.

Note: Ensure that the instrument has been running for at least one hour before any calibration is performed to ensure sufficient stability.

Note: Ensure units of measure are the same on both the barometer and instrument.

Equipment Required

- Barometer

Procedure

1. Disconnect any external tubing connected to the rear of the instrument.
2. Open - **Main Menu** → **Calibration Menu** → **Pressure Calibration** - (read displayed note) - OK.

Note: Entering this menu will switch off the internal pump and place the valve sequencing on hold; normal sampling will be interrupted.

3. Connect a barometer to the **Sample Port** (refer to Figure 6).
4. Edit - **Vacuum Set Point** - (read note) - OK.
5. Wait 2-5 minutes and ensure the pressure reading on the barometer is stable.
6. Enter the barometer reading into the instrument - Accept.
7. Read displayed instructions - OK.
8. The pump should now stop automatically. Disconnect the barometer from the **Sample Port**.
9. Wait 2-5 minutes and enter the ambient barometer reading into the instrument - Accept.

Note: Both cell and ambient pressure sensors should now be displaying the current ambient pressure and they should be the same value within 3 torr of each other.

10. Back - **Pressure Calibration Menu** - (read note) - OK.

5.4 Manual Background

A background is a measurement that is made when CO free air is drawn through the reaction cell. The resulting measurement signal (background) will include signals unrelated to CO. The background is an electronic baseline, it is normally run every 24 hours automatically. There is sometimes a need for the user to run a manual background.

Note: A manual background is recommended before commencing a multipoint precision check.

Equipment Required

- N/A

Procedure

1. Open - **Main Menu** → **Calibration Menu**.
2. Start - **Manual Background** → **Running**.
3. Manual background will now display running and will proceed to draw air from the CO-CO2 converter for 4 minutes (3 minutes of fill time and 1 minute of measure). The user can press stop at any time to cancel the background. At the end of the 4 minute period a new background voltage will be recorded in the event log as well as in the **Calculation Factors Menu**.

5.5 Zero Calibration

Zero calibrations are used to determine the zero response of the instrument and apply an offset to the reading.

Performing a zero calibration will adjust the **Zero Offset CO**. This offset can be checked in the **Main Menu** → **Service Menu** → **Calculation Factors Menu** and should be very close to zero. A large offset may indicate a problem with the instrument (refer to Section 7).

Note: Ecotech encourages regular zero precision checks; however Ecotech recommends that the zero calibration only be performed when specifically required as it may mask issues that should be addressed during maintenance/service.

A zero calibration can be performed either through the **Calibration Port**, **Background Air Port** or the **Sample Port**. Refer to the instructions outlined in the next three sections:

Note: Ensure the instrument has been running for at least one hour before any calibration is performed to ensure sufficient stability.

5.5.1 Calibration Port

Equipment Required

- Zero source

Procedure

1. Ensure a suitable zero source is connected to the **Calibration port**.
2. Open - **Main Menu** → **Calibration Menu**.
3. Select - **Cal. Type** → **Manual** - Accept.
4. Select - **Zero Source** → **External** - Accept.
5. Select - **Cal. Mode** → **Zero** - Accept.
6. Allow the instrument time to achieve a stable response.

7. Enter - **Zero Calibrate CO** - OK.
8. Select - **Cal. Mode** → **Measure** - Accept (To return to sample measure).

5.5.2 Sample Port

Equipment Required

- Zero source

Procedure

1. Ensure a suitable zero source is connected to the **Sample Port**.
2. Open - **Main Menu** → **Calibration Menu**.
3. Select - **Cal. Type** → **Manual** - Accept.
4. Select - **Zero Source** → **External** - Accept.
5. Select - **Cal. Mode** → **Measure** - Accept.
6. Allow the instrument time to achieve a stable response.
7. Enter - **Zero Calibrate CO** - OK.
8. Disconnect the zero source and reconnect the sample line to the **Sample Port**.

5.5.3 Background Air Port

Equipment Required

- N/A

Procedure

1. Open - **Main Menu** → **Calibration Menu**.
2. Select - **Cal. Type** → **Manual** - Accept.
3. Select - **Zero Source** → **Internal** - Accept.
4. Select - **Cal. Mode** → **Zero** - Accept.
5. Allow the instrument time to achieve a stable response.
6. Enter - **Zero Calibrate CO** - OK.
7. Select - **Cal. Mode** → **Measure** - Accept (To return to sample measure).

5.6 Span Calibration

A span calibration is a calibration performed at the upper end of the instrument's measurement range. Ecotech recommends calibration at 80 % of the full scale measurement or operating range of the instrument.

While the instrument range is commonly set as a default 0-50 ppm, this is widely recognised as no longer being valid with modern digital communication and most regulators will now recommend a range more suited to local conditions.

A span gas can be supplied through either the **Calibration Port** or **Sample Port**. Refer to the instructions outlined in the next two sections.

Note: Ensure that the instrument has been running for at least one hour before any calibration is performed to ensure sufficient stability.

5.6.1 Calibration Port

Equipment Required

- Span source

Procedure

1. Ensure a suitable span source is connected to the **Calibration Port**.
2. If diluting the gas with a dilution calibrator, set the output concentration to 80 % of the instrument measurement range.
3. Open - **Main Menu** → **Calibration Menu**.
4. Select - **Cal. Type** → **Manual** - Accept.
5. Select - **Cal. Mode** → **Span** - Accept.
6. Let the instrument stabilise, typically 15 minutes.
7. Enter - **Span Calibrate CO** - (Enter the span output concentration) - Accept.
8. Select - **Cal. Mode** → **Measure** - Accept (To return to sample measure).

5.6.2 Sample Port

Equipment Required

- Span source

Procedure

1. Ensure suitable span source is connected to the **Sample Port**.
2. If diluting the gas with a dilution calibrator, set the output concentration to 80 % of the instrument measurement range.
3. Open - **Main Menu** → **Calibration Menu**.
4. Select - **Cal. Type** → **Manual** - Accept.
5. Select - **Cal. Mode** → **Measure** - Accept.
6. Let the instrument stabilise, typically 15 minutes.
7. Enter - **Span Calibrate CO** - (Enter the span output concentration) - Accept.
8. Disconnect the span source and reconnect the sample line to the **Sample Port**.

5.6.3 Manual Instrument Gain and Offset Adjustments



CAUTION

Manual adjustment of the Instrument Gain does not take into account the PTF correction and can lead to an incorrect calibration

At times it may be desirable to manually adjust the instrument's gain and offset. Typically this option is only used when an instrument calibration has been corrupted and the user wishes to reset the instrument response factors prior to performing a new calibration.

To manually adjust the instrument follow the below procedure:

1. Open - **Main Menu** → **Service Menu** → **Calculation Factors Menu**.
2. Edit - **Instrument Gain** - (Adjust as required. 1 is the default) - Accept.
3. Edit - **Zero Offset CO** - (Adjust as required. 0 is the default) - Accept.

5.7 Precision Check

Similar to a normal zero or span calibration, a precision check is a *Level 2 calibration* that may be performed using a non-certified reference. The instrument is supplied with a known concentration of span gas (or zero air) and the instrument's response observed. However, no adjustment to the instrument response is made during a precision check.

Note: Ensure that the instrument has been running for at least one hour before any calibration is performed to ensure sufficient stability.

Equipment Required

- Span source
- Zero source

Procedure

1. Supply the instrument with a zero source (refer to Section 5.5 for the procedure of setting up a zero, but do not do a **Zero Calibrate CO**).
2. Observe and record the measurement from the instrument.
3. Supply the instrument with a span source (refer to Section 5.6 for the procedure of setting up a span but do not do a **Span Calibrate CO**).
4. Observe and record the measurement from the instrument.
5. Check both readings against your local applicable standards.

If an instrument fails a span precision check (based on the users local applicable standards), perform a span calibration (refer to Section 5.6).

If an instrument fails a zero precision check (based on the users local applicable standards), resolve the issue by referring to Section 6 (Service).

5.8 Multipoint Precision Check

A multipoint precision check is used to determine the linear response of the instrument across its operating range. The instrument is supplied with span gas at multiple known concentrations, typically a zero point and at least five up-scale points, spread across the operating range of the instrument. The observed concentrations are compared to expected values and the linearity of the instrument assessed against local applicable standards.

Note: The instrument is inherently linear and the instrument gain should **not** be adjusted at each individual point. Non-linearity indicates a problem with the instrument (refer to Section 7). Ensure that the instrument has been running for at least one hour before any calibration is performed to ensure sufficient stability.

Several methods for producing multiple known concentrations are available to use, such as connecting multiple certified gas cylinders at different concentrations. However, Ecotech strongly recommends the use of a dilution calibrator and a certified cylinder of CO at an appropriate concentration.

1. Connect your calibration system to the **Calibration Port** of the instrument (Ecotech recommends the Serinus Cal 1000 as a minimum, refer to Figure 45).
2. Generate and record the displayed span concentrations for (at least) six stepped points (of known concentrations) evenly spaced across the instruments measurement range (refer to the example below).
3. Then using a program such as MS Excel, create an X Y scatter plot of expected concentration versus the recorded instrument response and use linear regression to calculate the line of best fit and the correlation factor (R^2) – refer to the users local applicable standards.

Example for an instrument measurement range of 75 ppm:

- a. For the 1st concentration, set the gas dilution calibrator to supply **60 ppm** CO gas to the instrument.
- b. Allow the instrument to sample the calibration gas until a prolonged stable response is achieved (the amount of time this takes is impacted by the calibration setup). Record the instrument response.
- c. Repeat the above steps using concentrations of **50 ppm, 30 ppm, 20 ppm, 10 ppm** and a **Zero** point.

Note: To highlight hysteresis errors, it is advisable to run the multipoint check in both descending and ascending order - refer to your applicable local standards.

- d. Graph the results and use linear regression to determine a pass or fail as per your applicable local standards.
4. The linear regression equation will be displayed.

$$y = mx + c$$

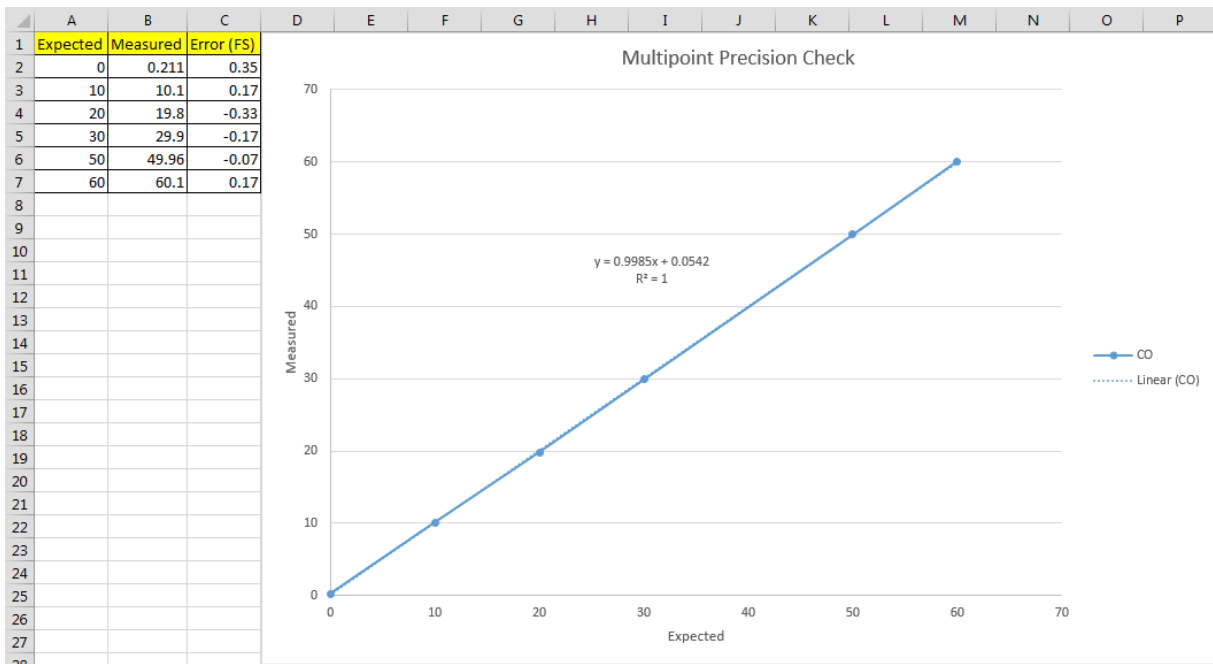

Figure 46 – Excel Graph of Multipoint Precision Check

5. The following is a guide to approximate expected good results.
 - a. The gradient (m) falls between 0.98 and 1.02.
 - b. The intercept (b) lies between -2 and +2.
 - c. The correlation (R^2) is greater than 0.99.
6. If unsatisfactory results are observed refer to Section 7.

5.9 Flow Calibration (Internal Pump Option Only)

This procedure calibrates the rate of the flow generated by the internal pump. The following procedure must be performed if the instrument:

- After a service or repair.
- When the external flow check has found the flow to be outside normal range.
- When a new pump has been installed.
- When the instrument is reset to factory defaults.

Equipment Required

- Calibrated Flow Meter

Procedure

1. Disconnect any external tubing connected to the rear ports of the instrument (**Sample Port**, **Exhaust Port**, etc.).
2. Open - **Main Menu** → **Calibration Menu** → **Flow Calibration Menu**.

3. Off - **Internal Pump** → **Off**.
4. Wait for the **Sample Flow** to become stable around 0 (± 0.01 slpm).
5. Set - **Cal. Zero** - Yes (Calibration of your zero point).
6. Connect a calibrated flow meter to the Sample Port.
7. On - **Internal Pump** → **On**.
8. Edit the **Coarse** and **Fine** pots until the flow meter reads the desired instrument **Sample Flow** rate (**Set Point**).

Note: Adjust the **Fine** pot to 253, adjust the **Coarse** to be as close as possible to desired reading and use **Fine** pot to make it exact.

9. Edit - **Cal. Point** - (Enter the reading from the flow meter) - Accept.
10. Select - **Flow Control** → **START** - Accept.
11. Leave for up to five minutes to return to normal operation. If instrument doesn't return to normal there may be a blockage (refer to Section 7).
12. Remove flow meter and reconnect external tubing.
13. Back - **Flow Calibration Menu** - (Read note) - OK

5.10 High Pressure Zero/Span Valve (Option)

If the instrument was ordered with this option, the internal pressurised calibration valves will already be installed within the instrument as either a zero or span calibration source, thus no other internal connections need to be made.

Note: Before using a high pressure span or zero as a source for calibrating the instrument, please check the local regulatory requirements. This is generally only be used as an operational check of the instrument's zero point and single span point (recommended as 80 % of full scale).

5.10.1 Single Pressurised Calibration Option

Set-Up of Single Calibration Option

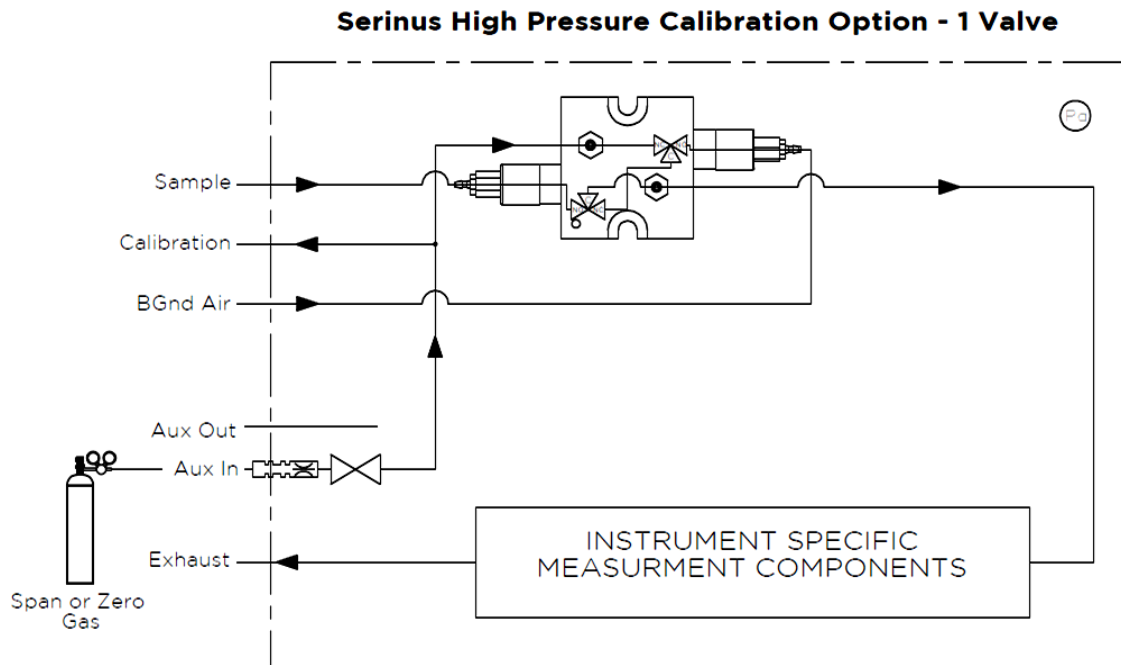

Figure 47 – Single High Pressure Calibration Option

When using the pressurised calibration option, either a high pressure zero or span cylinder (depending on the option you have ordered) should be connected to the **Aux In Port**.

Equipment Required

- Calibrated Flow Meter
- Gas Cylinder

Procedure

1. Ensure the gas cylinder is fitted with an appropriate gas regulator with a shut off valve.
2. Connect a ¼" line of stainless steel tubing between the gas cylinder and the instruments **Aux In Port**.

Note: This connection may need to be retightened during this operation.

3. Open the cylinder main valve and adjust the regulator to 15 psig.
4. Open the regulator's shutoff valve and test for leaks:
 - a. Pressurise the line.
 - b. Close the cylinder main valve.
 - c. If pressure drops by more than 2 PSI over five minutes, check the connections and retest.

- d. Open cylinder main valve.
5. Temporarily place a flow meter on the **Calibration Port** (This port is now used as the high pressure calibration vent).
6. Open - **Main Menu** → **Calibration Menu**.
7. Select - **Cal. Type** → **Manual** - Accept.
8. Select - **Cal. Mode** → **Span** or **Zero** - Accept (Depending on the option installed).

Note: When using the high pressure zero option, ensure **Zero Source** is set to **External**.

9. Adjust the regulator pressure until the flow meter on the vent line (**Calibration Port**) is between 0.5 and 1 slpm. This flow rate is you excess calibration gas.

Note: Do not exceed a pressure of 2 bars, this can damage the instrument and cause gas leakage.

Return to Normal Operation

1. Select - **Cal. Mode** → **Measure** - Accept. (To return to sample measure).
2. Remove the flow meter on the **Calibration Port** and connect a vent line.
3. Reconnect the instrument fittings and return to the original set-up.

The instrument is now in normal operation mode. When either zero or span calibration is initiated (depending on which option has been installed) the instrument will automatically open the valves to run a pressurised calibration.

5.10.2 Dual Pressurised Calibration Option

Set-Up of Dual Calibration Option

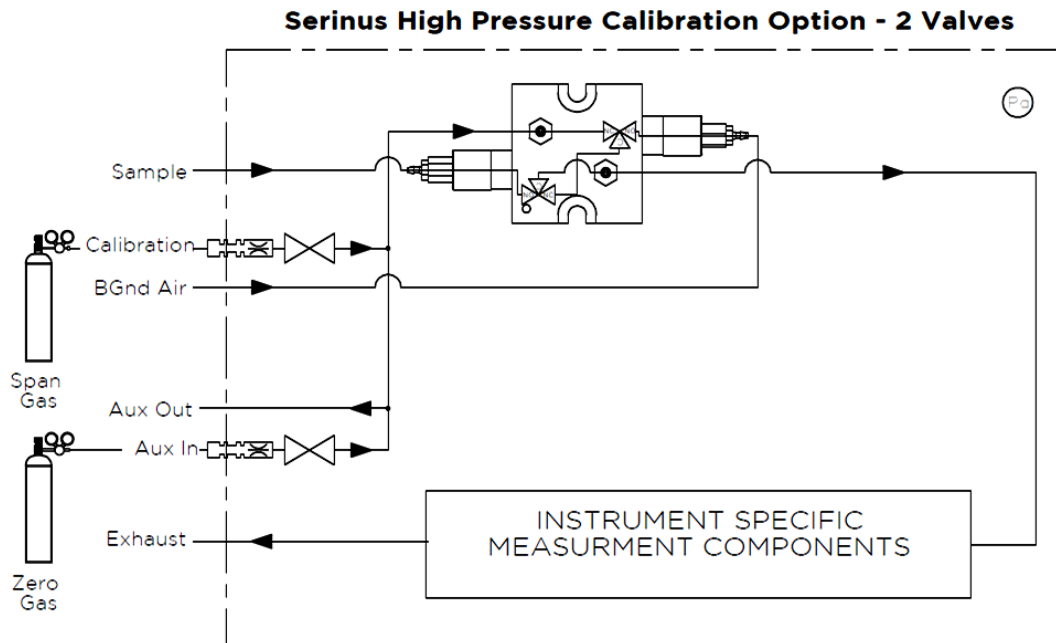

Figure 48 – Dual High Pressure Calibration Option

When using the dual pressurised calibration option, a high pressure zero cylinder should be connected to the **Aux In** port and a high pressure span cylinder connected to the **Calibration** port.

Equipment Required

- Calibrated Flow Meter
- Gas Cylinder of Zero air
- Gas Cylinder of CO

Procedure

1. Ensure the gas cylinder is fitted with an appropriate gas regulator with a shut off valve.
2. Connect a ¼" line of stainless steel tubing between the appropriate gas cylinders and the instrument's **Aux In Port** and **Calibration Port**.

Note: This connection may need to be retightened during this operation.

3. Open the cylinder main valve and adjust the regulator to 15 psig.
4. Open the regulator's shutoff valve and test for leaks:
 - a. Pressurise the line.
 - b. Close the cylinder main valve.
 - c. If pressure drops by more than 2 PSI over five minutes, check the connections and retest.
 - d. Open cylinder main valve.

5. Temporarily place a flow meter on the **Aux Out Port** (This port is now used as the high pressure calibration vent for both span and zero).
6. Open - **Main Menu** → **Calibration Menu**.
7. Select - **Cal. Type** → **Manual** - Accept.
8. Select - **Cal. Mode** → **Zero** - Accept.

Note: When using the high pressure zero option, ensure **Zero Source** is set to **External**.

9. Adjust the regulator pressure until the flow meter on the vent line (**Aux Out**) is between 0.5 and 1 slpm. This flow rate is you excess calibration gas.

Note: Do not exceed a pressure of two bars, this can damage the instrument and cause gas leakage.

10. Select - **Cal. Mode** → **Span** - Accept.
11. Adjust the regulator pressure until the flow meter on the vent line (**Aux Out**) is between 0.5 and 1 slpm. This flow rate is you excess calibration gas.

Note: Do not exceed a pressure of two bars, this can damage the instrument and cause gas leakage.

Return to Normal Operation

1. Select - **Cal. Mode** → **Measure** - Accept. (To return to sample measure).
2. Remove the flow meter on the **Aux Out Port** and connect a vent line.
3. Reconnect the instrument fittings and return to the original set-up.

The instrument is now in normal operation mode. When either zero or span calibration is initiated the instrument will automatically open the valves to run a pressurised calibration.

6. Service

6.1 Maintenance Tools

To perform general maintenance on the Serinus 30 the user may require the following equipment:

- Customizable Test Equipment Case PN: H070301
- Digital Multimeter & Leads (DMM) PN: E031081 & E031082
- Barometer PN: E031080
- Thermometer & Probe PN: E031078 & E031079
- Flow Meter (Select Range)
 - Range: 50 sccm to 5000 sccm PN: ZBI-200-220M
 - Range: 300 sccm to 30000 sccm PN: ZBI-200-220H
- Minifit Extraction Tool PN: T030001
- Orifice/Sintered Filter Extraction Tool PN: H010046
- Leak Test Jig PN: H050069
- Computer/Laptop and Connection Cable for Diagnostic Tests
- 1.5 mm Hex Key
- Assortment of 1/4" and 1/8" Tubing and Fittings
- Zero Air Source
- Span Gas Source



Figure 49 – Minifit Extraction Tool – (PN: T030001)

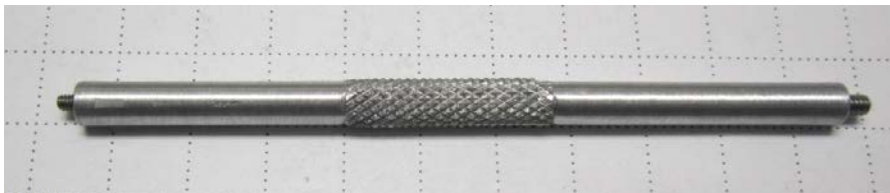

Figure 50 – Orifice/Sintered Filter Removal Tool – (PN: H010046)

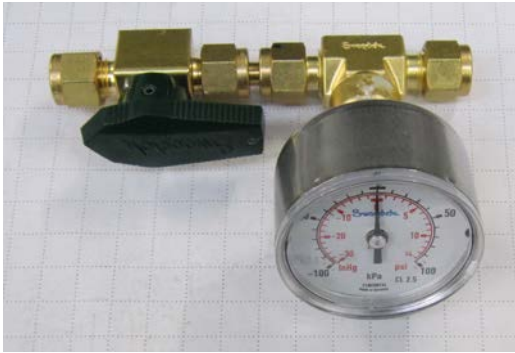

Figure 51 – Leak Test Jig – (PN: H050069)



Figure 52 – Air Monitoring Test Equipment Kit (AMTEK) – Customisable

6.2 Maintenance Schedule

The maintenance intervals are determined by compliance standards that differ in various regions. The following is recommended by Ecotech as a guide. Compliance with local regulatory or international standards is the responsibility of the user.

Table 6 – Maintenance schedule

Interval *	Task performed	Section
Weekly	Check inlet particulate filter, replace if full/dirty	6.3.1
	Check sample inlet system for moisture or foreign materials. Clean if necessary	
	Perform precision check	5.7
	Check instrument status light is ok (green)	

Monthly	Perform leak check	6.3.4
	Check fan filter, clean if necessary	6.3.2
	Perform span calibration	5.6
6 Monthly	Check date and time is correct	3.4.8
	Check the CO-CO ₂ converter	6.3.5
	Perform multipoint precision check	5.8
Yearly	Replace DFU filter	6.3.3
	Replace sintered filter and orifice (only if necessary)	6.3.6
	Trim pot tuning procedure	6.3.7
	Perform pressure check	6.3.9

* Suggested intervals for maintenance procedure are a guide only and may vary with sampling intensity and/or environmental conditions.

6.3 Maintenance Procedures

6.3.1 Particulate Filter Replacement

Contamination of the filter can result in degraded performance of the instrument, including slow response time, erroneous readings, temperature drift and various other problems.

1. Turn off the vacuum source and allow the instrument to return to ambient pressure.
2. Slide open the lid of the instrument to access the particulate filter (located in front right hand corner). Unscrew the filter cap (bright blue) by turning it counter-clockwise.
3. Remove the filter plunger from the casing, place finger on tubing connector and pull to the side (refer to Figure 53).

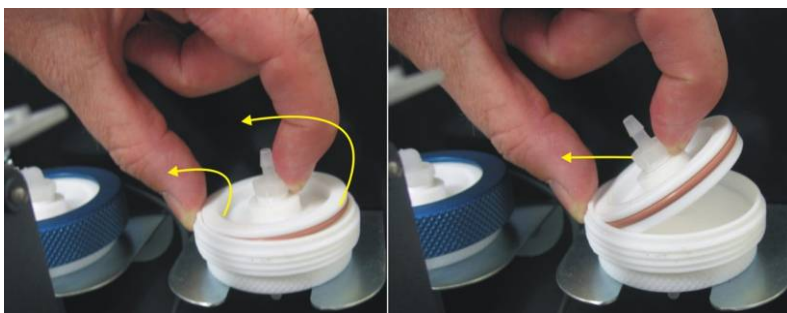

Figure 53 – Removing the Plunger

4. Remove the old filter paper, wipe down the plunger with a damp cloth and insert a new filter.
5. Replace the plunger, screw the cap on and reconnect the pump.
6. Close the instrument and perform a leak check.

6.3.2 Clean Fan Filter

The fan filter is located on the rear of the instrument. If this filter becomes contaminated with dust and dirt it may affect the cooling capacity of the instrument.

1. Remove outer filter casing and filter.
2. Clean filter with water and wring dry or shake vigorously.
3. Reinstall filter and filter casing.



Figure 54 – Removing the Fan Filter

6.3.3 DFU Replacement

1. Turn the instrument off and unplug from the power.
2. Remove the Kynar nut from the end of the DFU by turning it anti-clockwise (looking from the DFU side).
3. Replace the DFU and ensure that the flow is in the correct direction (arrow should point towards the Kynar nut).
4. Tighten the Kynar nut clockwise.



Figure 55 – DFU Filter

6.3.4 Leak Check

Equipment Required

- Vacuum Source (Pump)
- Leak Test Jig (PN: H050069)
- Kynar 1/4" Blocker Nuts
- 5/8" Spanner
- 9/16" Spanner

Note: Ensure that the instrument has been running for at least one hour before this procedure is performed.

Procedure

1. Turn off the vacuum source and allow the instrument to return to ambient pressure.
2. Disconnect any external tubing connected to the rear of the instrument.
3. Connect the leak check jig to the Exhaust Port of the instrument.



Figure 56 – Leak Test Jig on Exhaust

4. Connect a vacuum source to the shut off valve ensuring the shut off valve is in the open position.
5. Block the instrument's **Sample**, **Calibration** and **Background Air** Ports with Kynar 1/4" blocker plugs.
6. Open - **Main Menu** → **Service Menu** → **Diagnostics Menu** → **Valve Menu**.
7. Disable - **Valve Sequencing** → **Disabled**.
8. Close - **Sample/Cal** → **Closed**.
9. Close - **Internal Zero/Cal** → **Closed**.
10. Close - **Pressurized Zero (OPT)** → **Closed**.
11. Close - **Pressurized Span (OPT)** → **Closed**.
12. Close the shut off valve and record the vacuum indicated on the leak test jig. Wait for three minutes and observe the gauge on the leak test jig. It should not drop more than 5 kpa. If it has, a leak is present within the sample cycle of the instrument.
13. Open - **Sample/Cal** → **Open**.
14. Open the shut off valve and allow the vacuum source to evacuate the pneumatics.

15. Close the shut off valve and record the vacuum indicated on the leak test jig. Wait for three minutes and observe the gauge on the leak test jig. It should not drop more than 5 kpa. If it has, a leak is present within the zero cycle of the instrument.
16. Open - **Internal Zero/Cal → Open.**
17. Open the shut off valve and allow the vacuum source to evacuate the pneumatics.
18. Close the shut off valve and record the vacuum indicated on the leak test jig. Wait for three minutes and observe the gauge on the leak test jig. It should not drop more than 5 kpa. If it has, a leak is present within the span calibration cycle of the instrument.
19. If the instrument did not leak, skip to step 22.
20. Inspect the instrument's plumbing looking for obvious damage. Check the condition of fittings, particulate filter housing plus the O-rings.
21. When the location of the leak has been determined, repair and re-run the leak check procedure.
22. Inspect the tubing again ensuring the tubing is cleanly connected to the fittings and that the internal Teflon lining has not been kinked or crumpled.
23. Remove the leak check jig and Kynar blocking nuts.
24. Open - **Main Menu → Service Menu → Diagnostics Menu → Valve Menu.**
25. Enable - **Valve Sequencing → Enabled.**

6.3.4.1 Leak Check (Internal pump option)

Equipment Required

- Barometer
- Kynar ¼" Blocker Nuts
- 5/8" Spanner
- 9/16" Spanner
- 7/16" Spanner

Procedure

Note: Ensure that the instrument has been running for at least one hour before this procedure is performed.

1. Disconnect all external tubing connected to the rear ports of the instrument.
2. Open - **Main Menu → Service Menu → Diagnostics Menu → Internal Pump Menu.**
3. Select - **Flow Control → Manual** - Accept.
4. Edit - **Coarse** - (set to 255) - Accept.
5. Edit - **Fine** - (set to 255) - Accept.
6. Open - **Main Menu → Service Menu → Diagnostics Menu → Valve Menu.**
7. Disable - **Valve Sequencing → Disabled.**
8. Turn **Off** all the valves.
9. Block the **Sample Port** with a barometer.

10. Allow the internal pump to time to evacuate the pneumatic system (the time required will depend on the condition of the pump 1 to 2 minutes).
11. Open - **Main Menu → Service Menu → Diagnostics Menu → Internal Pump Menu.**
12. Toggle Off - **Internal Pump → Off.**
13. Note the value on the barometer. Wait for three minutes, the value should not drop more than 5 kpa (37.5 torr). If the leak check passed skip to step 16.
14. Inspect the instrument's plumbing looking for obvious damage. Check the condition of fittings, particulate filter housing plus the O-rings.
15. If the leak is still present divide up the pneumatic system into discrete sections to locate the leak (refer to Section 9.5). When the location of the leak has been determined repair and then rerun the leak check procedure.
16. Remove the barometer from the **Sample Port**, slowly allow the instrument to return to ambient.
17. Open - **Main Menu → Service Menu → Diagnostics Menu → Valve Menu.**
18. Enable - **Valve Sequencing → Enabled.**
19. Open - **Main Menu → Service Menu → Diagnostics Menu → Internal Pump Menu.**
20. Select - **Flow Control → Start** - Accept.

6.3.5 CO-CO₂ Converter Check

The internal CO-CO₂ converter provides a source of continuous CO free air for auto-zero and background functions. Failure of the converter can result in drift, poor sensitivity near zero and continuous electronic zero adjusts.

Note: Ensure that the instrument has been running for at least one hour before this procedure is performed.

Equipment Required

- Span gas source 40ppm CO
- 5/8" Spanner

Procedure

1. Open - **Main Menu → Calibration Menu.**
2. Select - **Cal. Type → Manual** - Accept.
3. Select - **Zero Source → Internal** - Accept.
4. Select - **Cal. Mode → Zero** - Accept.
5. Allow the instrument to sample **Zero** air from the CO-CO₂ for approximately five minutes.
6. Record the instrument response as the "Initial" value.

Note: This value should be 0.00 ±0.1 ppm. If it is not, a background should be initiated by initiating the background field within the calibration menu. The background will take approximately five minutes to complete.

7. Connect 40 ppm CO span source to the **Background Air Port** ensuring the inlet pressure is maintained at ambient (vented).
8. Allow the instrument to sample the span source for five minutes.
9. Record the instrument response as the “Challenge” value.
10. Disconnect the span source.
11. Open - **Main Menu** → **Calibration Menu**.
12. Select - **Cal. Type** → **Manual** - Accept.
13. Select - **Zero Source** → **External** - Accept.
14. Select - **Cal. Mode** → **Measure** - Accept.
15. Compare the initial value and the challenge value. They should agree within ± 2 ppm. If not the CO-CO₂ converter should be replaced.

6.3.6 Sintered Filter/Orifice Replacement

Equipment Required

- Orifice/filter removal tool (PN: H010046)
- 9/16” Spanner

Procedure

1. Remove the Vacuum source from the **Exhaust Port**.
2. Unscrew the Kynar nut from the fitting (anti-clockwise) on the **Measurement Cell** (refer to Figure 57).

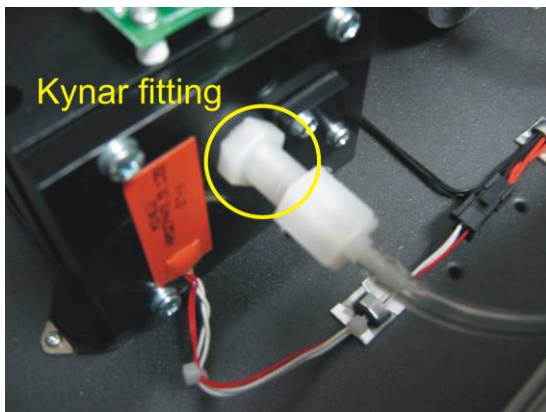

Figure 57 – Kynar Fitting Containing Orifice and Sintered Filter

3. Use the orifice/sintered filter extraction tool to screw into the orifice (clockwise) and gently pull the orifice out of the fitting.
4. Repeat the process again for the sintered filter using the other end of the orifice/sintered filter extraction tool.
5. The orifice can now be cleaned or exchanged as required. The sintered filter is normally replaced.
6. Replace the sintered filter then the orifice back into the fitting with the orifice/filter extraction tool.

7. Replace the Kynar nut back into the **Measurement Cell**.
8. Perform a leak check (refer to Section 6.3.4).
9. Reconnect the vacuum source to the **Exhaust Port**.

6.3.7 Trim Pot Tuning Procedure

The following must be performed to ensure the Serinus 30 receives an optimal signal after the cell has been aligned. If this procedure is not performed, the Serinus 30 is likely to produce unstable results. If the **Input Pot** reads less than 180 (refer to Section 3.4.15), this is an indication that this procedure needs to be performed.

Equipment Required

- Pot Adjustment tool

Procedure

1. Open - **Main Menu** → **Service Menu** → **Diagnostics Menu**.
2. Disable - **Control Loop** → **Disabled**.
3. Open - **Digital Pots Menu**.
4. Edit - **Input Pot** - (Adjust to 200) - Accept.
5. Adjust the trim pot on the detector assembly (refer to Figure 3) such that the **Ref. Voltage** reads $3.80\text{ V} \pm 0.05\text{ V}$.
6. Back - **Diagnostics Menu**.
7. Enable - **Control Loop** → **Enabled**.
8. Reset the instrument.
9. Ensure that the Input pot reads 200 ± 10 after the instrument is out of warm-up. If not, perform this procedure again.

6.3.8 Clean Pneumatics

The **Calibration Valve Manifold** (refer to Figure 3) will require disassembling and cleaning. Ideally the valves and the manifold should be cleaned in a sonic bath with lab detergent and distilled water. Once clean rinse with distilled water and dry with clean dry oil free air before reassembling. A leak test should be performed once the instrument is ready for operation (refer to Section 6.3.4).

Note: If the tubing shows signs of significant contamination, it should be replaced with new tubing. Do not clean the **CO-CO2 converter** or the mirrors found within the **Measurement Cell**.

6.3.9 Pressure Sensor Check

Pressure checks are needed to ensure that the pressure sensor is accurately measuring pressure inside the instrument.

During normal operation ensure that the pressure and flow menu indicate the following parameters. Ambient should display the current ambient pressure at site. Cell should indicate current cell

pressure depending on the pump condition and location. The cell pressure is normally about 20 torr below ambient.

Equipment Required

- Barometer
- Digital Multimeter (DMM)

Procedure

1. Open - **Main Menu** → **Analyser State Menu** → **Pressure & Flow Menu**.
2. Disconnect the exhaust and sample port connections.
3. After two-five minutes observe the pressure readings: ambient and cell. Ensure that they are reading the same ± 3 torr (± 0.4 kPa).
4. If the readings are outside this level, perform a pressure calibration (refer to Section 5.2).

If the pressure calibration fails, the instrument may have a hardware fault. The cell pressure PCA has test points. To determine the condition of the sensor measure and the voltage on the test points, refer to Figure 58. The voltage measured across the test points is proportional to the pressure measured by the sensor. If the sensor is exposed to ambient pressure at sea level, the voltage will be around 4 volts but if the sensor is under vacuum, the voltage will be low (e.g. 0.5 volts). If the test point measures zero or negative voltage, the assembly is most likely faulty and will need to be replaced.

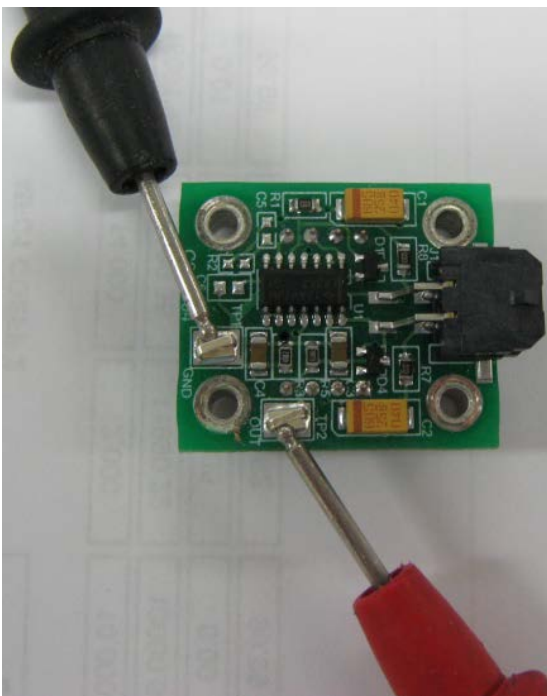

Figure 58 – Test Point Location

6.4 Bootloader

The Serinus Bootloader is the initial set of operations that the instruments' microprocessor performs when first powered up (similar to the BIOS found in a personal computer). This occurs every time the instrument is powered up or during instrument resets. Once the instrument boots up, it will automatically load the instruments' firmware. A service technician may need to enter the Bootloader to perform advanced microprocessor functions as described below.

To enter the Bootloader turn off the power to the instrument. Press and hold the plus key while turning the power on. Hold the Plus key until the following screen appears.

Ecotech Analyser / Calibrator
V3.0 Bootloader
Press '1' to enter Bootloader

If the instrument displays the normal start up screen, the power will need to be toggled and another attempt will need to be made to enter the Bootloader. Once successful, press 1 to enter the **Bootloader Menu**.

6.4.1 Display Help Screen

Once in the Bootloader screen it is possible to redisplay the help screen by pressing 1 on the keypad.

6.4.2 Communications Port Test

This test is very useful for fault finding communication issues. It allows a communication test to be carried out independent to any user settings or firmware revisions.

This command forces the following communication ports to output a string of characters: Serial Port RS232 #1, USB rear and Ethernet Port. The default baud rate is 38400 for the RS232 Serial Port. To initiate the test press the number 2 key from the Bootloader screen.

6.4.3 Updating Firmware

It is important for optimal performance of the instrument that the latest firmware is loaded. The latest firmware can be obtained by visiting Ecotech's website:

<http://www.ecotech.com/downloads/firmware>

Or by emailing Ecotech at **service@ecotech.com** or **support@ecotech.com**

To update the firmware from a USB memory stick, use the following procedure:

USB Memory Stick Update

1. Turn the instrument off.
2. Place the USB memory stick with the new firmware (ensure that firmware is placed in a folder called FIRMWARE) in the front panel USB Port.
3. Enter the Bootloader (refer to Section 6.4).
4. Select option 3 (upgrade from USB memory stick), press 3 on the keypad.
5. Wait until the upgrade has completed.

6. Press 9 on the keypad to start the instrument with the new firmware.

6.4.4 Erase All Settings

This command is only required if the instruments firmware has become unstable due to corrupted settings. To execute this command enter the **Bootloader Menu** (refer to Section 6.4) and press 4 on the keypad.

6.4.5 Start Analyser

The start analyser command will simply initiate a firmware load by pressing 9 on the keypad from the **Bootloader Menu**. It is generally used after a firmware upgrade.

7. Troubleshooting

Before troubleshooting any specific issues, Ecotech recommends ensuring the instrument has successfully completed its warm-up routine and resolving all issues listed in the instrument status menu (refer to Section 3.4.4).

Table 7 – Troubleshoot List

Error Message/Problem	Cause	Solution
Flow fault	Multiple possibilities	Refer to Section 7.1.
	Pump failed	Replace the internal or external pump.
	Blocked filter or orifice - only installed in external pump optioned instrument.	Replace sintered filter and orifice.
	Pressurised measurement cell	Ensure sample and zero inlets are maintained at ambient pressure (vented to atmosphere)
	Pressure sensors	Recalibrate or replace the pressure sensors.
Noisy/unstable readings	Multiple possibilities	Refer to Section 7.2.
	Calibration system error	Ensure calibration system is functioning correctly and is leak free. Ensure sufficient gas is available for instrument and an adequate vent is available for excess gas.
	Leaks	A leak in the instrument or calibration system dilutes the sample stream and causes low span readings and noise.
	Temperature unstable	<ul style="list-style-type: none"> ▪ A failed temperature control allows the instrument to drift with ambient temperature. Verify that both the cell and mirror temperatures are $50\text{ }^{\circ}\text{C} \pm 3\text{ }^{\circ}\text{C}$. ▪ Chassis lid not in place causing instrument to drift with ambient temperature. ▪ Chassis temperature drifting with ambient temperature fluctuations. Stabilise ambient temperature and remove instrument from direct ambient heating or cooling.
	Hardware fault	Measurement cell internal hardware loose. Mirrors have detached or degraded.
	Commissioning error	Measurement cell travel screws are still fastened (refer to Section 2.3.4).

Error Message/Problem	Cause	Solution
	Gain too high	<ul style="list-style-type: none"> ▪ Leak check, repair any leaks. (refer to Section 6.3.4) ▪ Measurement cell internal hardware loose – return to nearest service centre. ▪ Mirrors have detached or degraded – return to nearest service centre. ▪ Correlation wheel has leaked replace correlation wheel.
Cell temperature failure	Faulty heater or temperature sensor	Refer to Section 7.3.
Mirror temperature failure	Faulty heater or temperature sensor	Refer to Section 7.4.
Instrument resetting	Multiple possibilities	<ul style="list-style-type: none"> ▪ Check that the instrument is not overheating. ▪ Possibly a faulty power supply. ▪ Corrupted firmware. Perform an ‘erase all settings’ in the Bootloader Menu and reload or upgrade firmware (refer to Section 6.4.4).
12 Voltage supply failure	Power supply has failed	Replace power supply.
No display	Contrast adjustment required	Adjust the display contrast by pressing either of the two scrolling buttons on the front panel: <ul style="list-style-type: none"> ▪ Press Up scrolling button (▲) for darker contrast. ▪ Press Down scrolling button (▼) for lighter contrast.
	DC power	Verify that the power supply is providing ±12 V, +5 V DC. TP40, TP23 and TP41.
	Display	Check the interface cable between the display and the microprocessor board.
	Bad display or main controller PCA	<ul style="list-style-type: none"> ▪ Replace the front panel display. ▪ Replace the main controller PCA. ▪ Bad cables are unlikely, but if suspect it; perform a pin-for-pin continuity test using an ohmmeter.
	AC power	<ul style="list-style-type: none"> ▪ Verify that the mains power cable is connected and the rear fan is operating.
Sample pressure too high or low	Loss of pressure calibration	<ul style="list-style-type: none"> ▪ Perform a pressure calibration (refer to section 5.2). ▪ Ensure particulate filter has been recently changed. ▪ Ensure tubing is not kinked or blocked. ▪ Ensure vacuum pump is correctly installed and operating.

Error Message/Problem	Cause	Solution
Sample flow not at 1 slpm	Multiple possibilities	<ul style="list-style-type: none"> ▪ Check/replace sample filter. ▪ Check pump. ▪ Check valves. ▪ Check/replace sintered filter. ▪ Re-calibrate pressure sensors.
Unstable flow or pressure readings	Faulty pressure sensors	<ul style="list-style-type: none"> ▪ Check pressure calibration. ▪ Check calibration valve block is functioning and not blocked. If unable to diagnose problem, check the voltage across TP1 and TP2 of pressure sensor PCA. Ensure it is about 4 volts ± 0.3 volts. If unable to diagnose problem, it may be a noisy A/D converter, replace main controller PCA.
Low span	Leaks	<ul style="list-style-type: none"> ▪ A leak in the instrument or calibration system dilutes the sample stream and causes low span readings and noise. ▪ Correlation wheel has leaked replace correlation wheel.
	Span calibration out	Adjust the span using the calibration procedure (refer to Section 5.6).
No response to span gas	Leaks/blockages	Leak or blockages in tubes or valves. Perform leak check and flow check and repair any leaks/blockages.
	Faulty calibration source	Ensure calibration gas is plumbed correctly and is not contaminated or has no leaks and is a certified reference gas.
	Hardware fault	Faulty Measurement cell.
	Correlation wheel leaking	Replace correlation wheel.
Zero drift	Poor temperature control	Ensure instrument is operated in a temperature controlled environment with the lid on.
	Faulty zero air	Ensure zero air source is not overly polluted.
	Leak	Perform a leak test (refer to Section 6.3.4).
	CO-CO ₂ converter faulty	Replace CO-CO ₂ converter.
Negative zero	Indicates that the internal zero air converter is less efficient than the external zero air supplied	<p>Perform a leak test (refer to Section 6.3.4).</p> <p>Check the internal zero air supply is equipped with a functioning CO removing device.</p>

7.1 Flow Fault

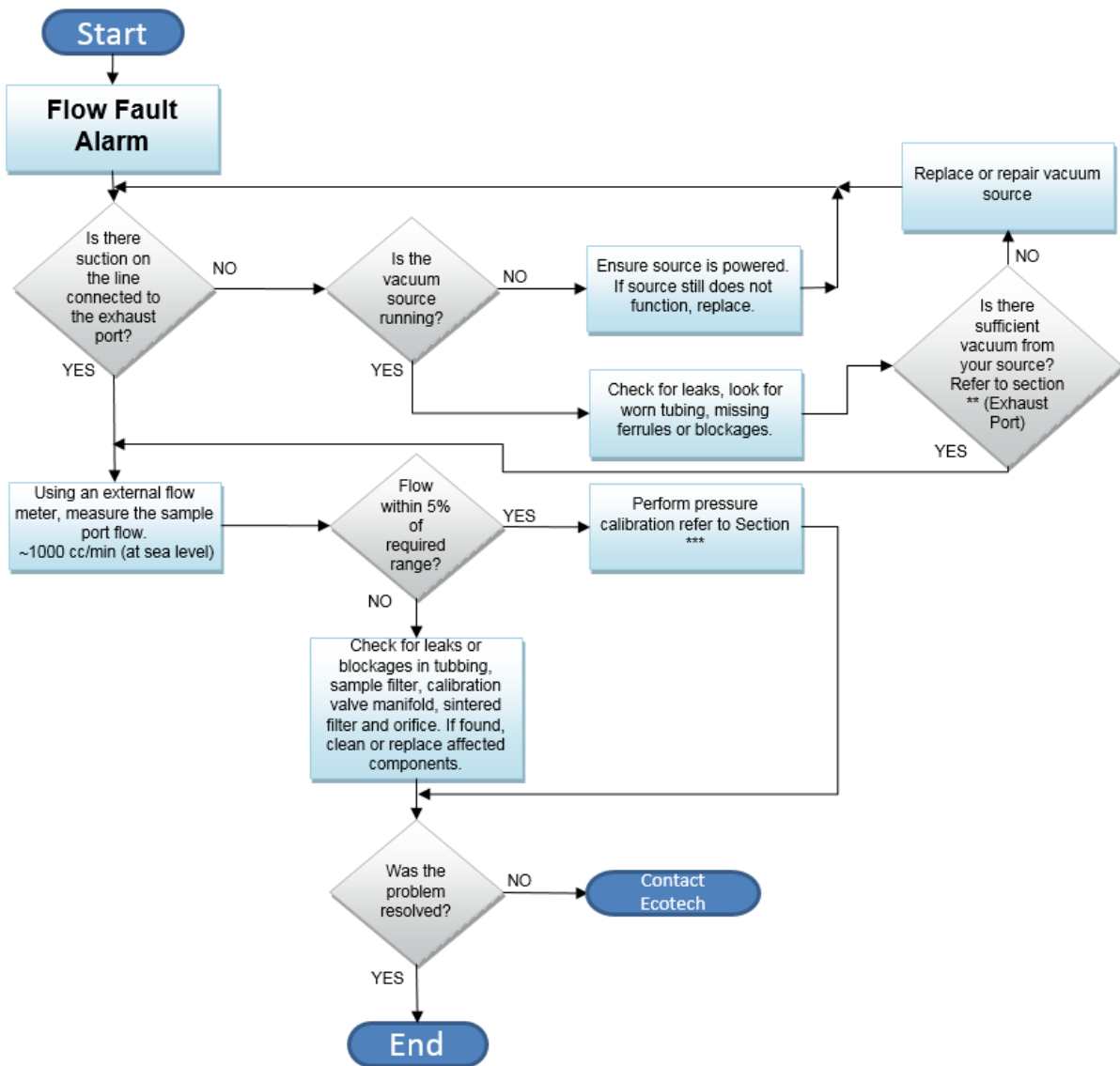

Figure 59 – Flow Fault Diagnostic Procedure

** Section 2.3.1

*** Section 5.2

7.2 Noisy/Unstable Readings

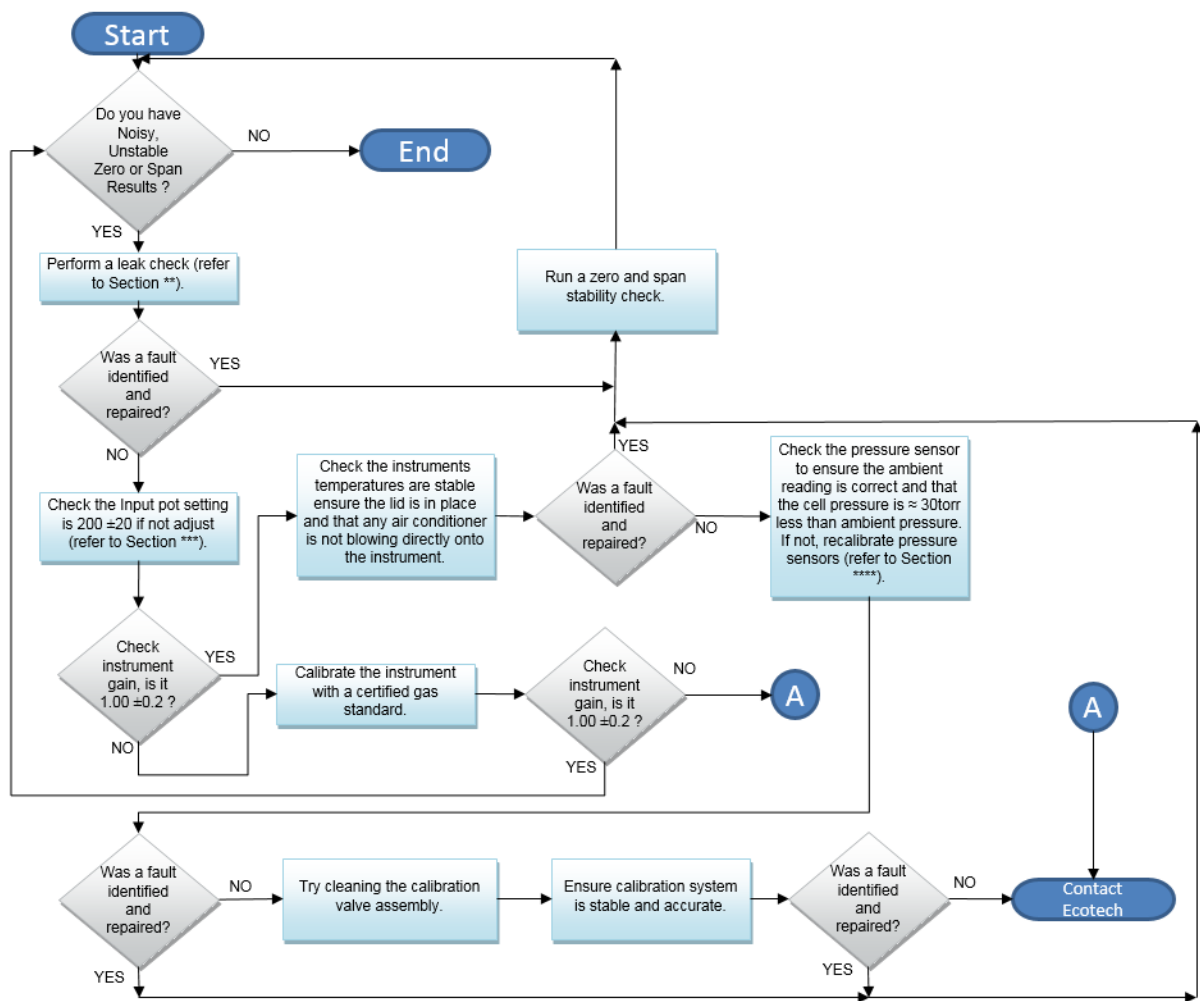

Figure 60 – Noisy Zero or Unstable Span Diagnostic Procedure

** Section 6.3.4

*** Section 6.3.7

**** Section 5.2

7.3 Cell Temperature Failure

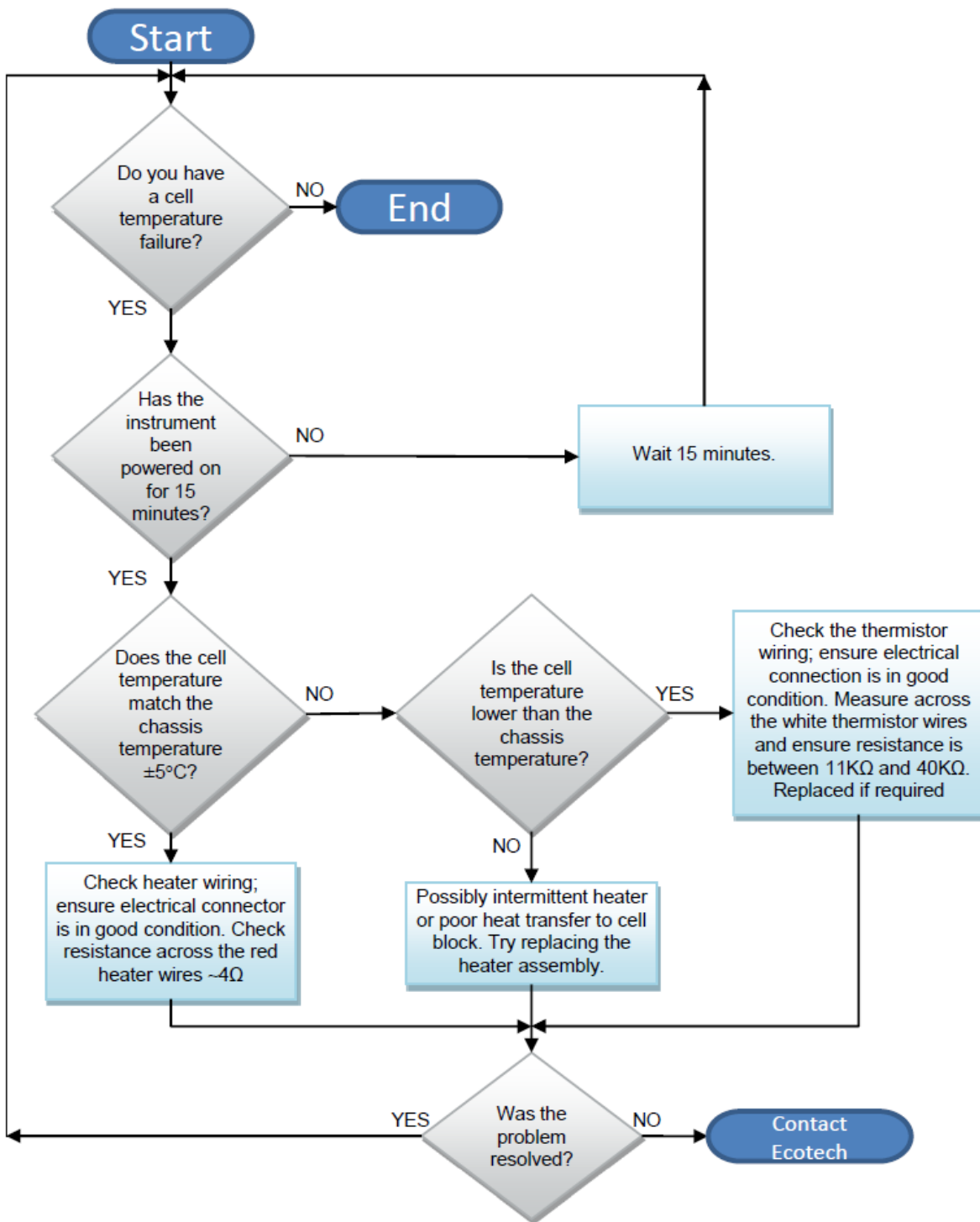

Figure 61 – Cell Temperature Failure Diagnostic Procedure

7.4 Mirror Temperature Failure

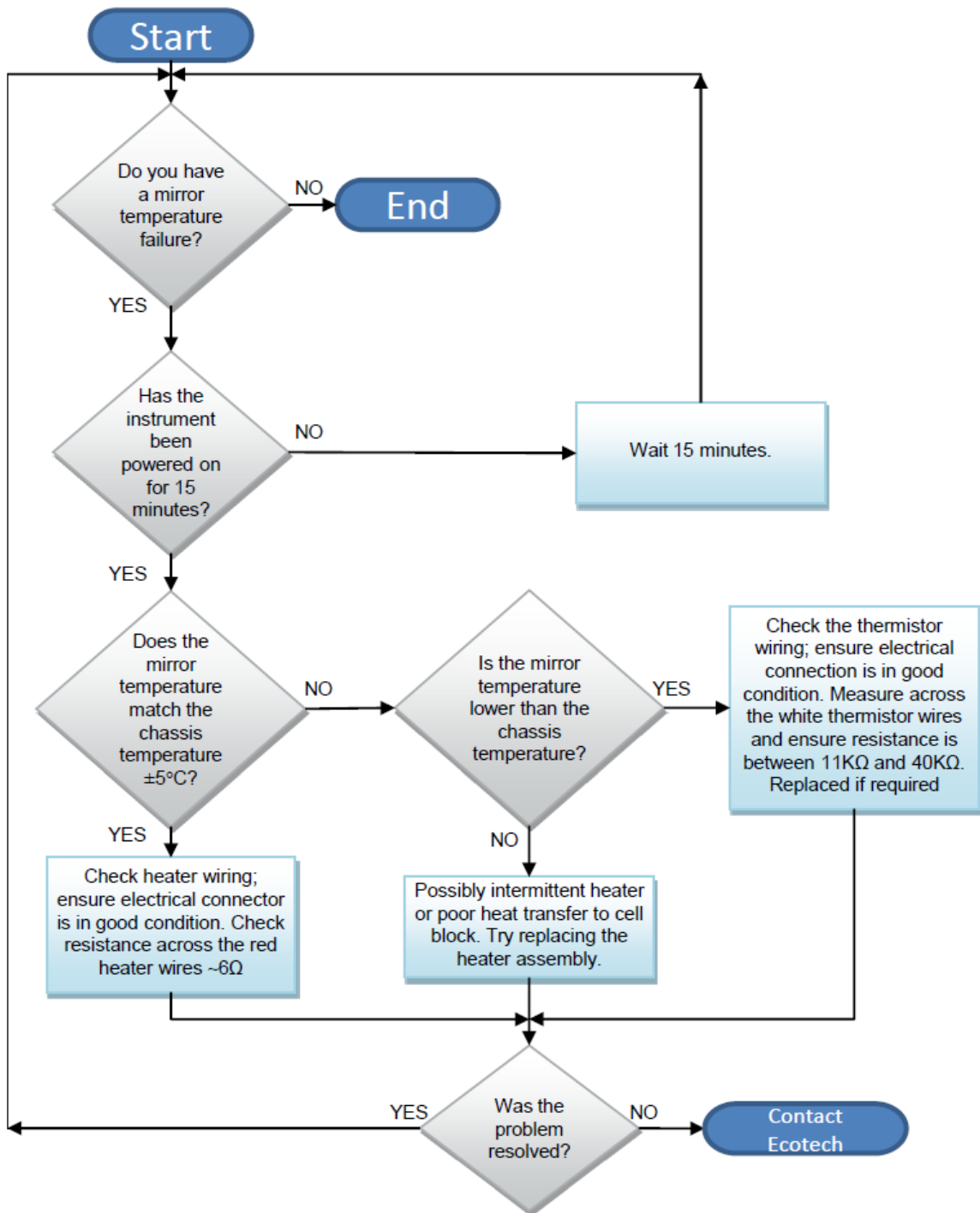

Figure 62 – Mirror Temperature Failure Diagnostic Procedure

7.5 USB Memory Stick Failure

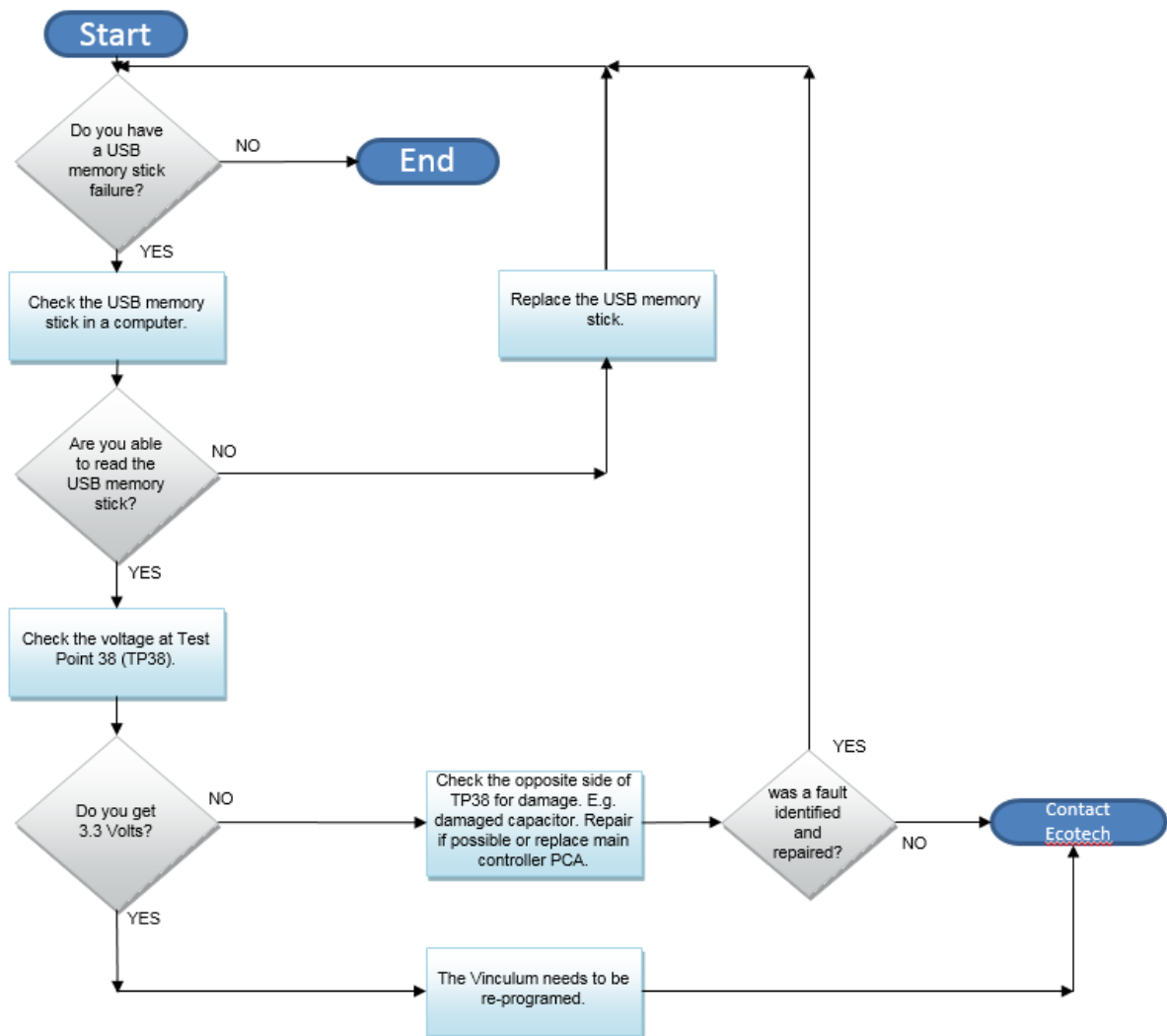

Figure 63 – USB Memory Stick Failure

7.6 Ecotech Service Support Files

Regular backup of the settings, parameters and data on the instruments USB memory stick is recommended.

In the event of a fault that requires Ecotech technical support, please make copies of the following files and email to **support@ecotech.com**.

Equipment Required

- PC/Laptop

Procedure

State the ID number, variant, board revision and firmware version of the instrument with a brief description of the problem. Take a copy of the current configuration if possible and a save of the parameters.

1. Open - **Main Menu** → **Analyser State Menu**.
2. **Variant** - (take note).
3. **Ecotech ID** - (take note).
4. **Board Revision** - (take note).
5. **Firmware Ver.** - (take note).
6. Open - **Main Menu** → **Service Menu**.
7. Save - **Save Configuration** - (CONFIG**.CFG) - Accept.

Note: CONFIG99.CFG is the “Factory Backup” file, this is the configuration of the instrument as it left the factory. It is recommended that this file is kept unchanged but can be used as a reference backup point.

** Can be any number from 0 – 98.

8. Save - **Save Parameter List** - (PARAM**.TXT) - Accept.
9. Eject - **Safely Remove USB Stick** - (Follow instructions).

Note: PARAM99.TXT is the “Factory Backup” file, This is a snap shot of the parameters while it was under test in the factory just prior to release. It is recommended that this file is kept unchanged but can be viewed for reference.

** Can be any number from 0 – 98.

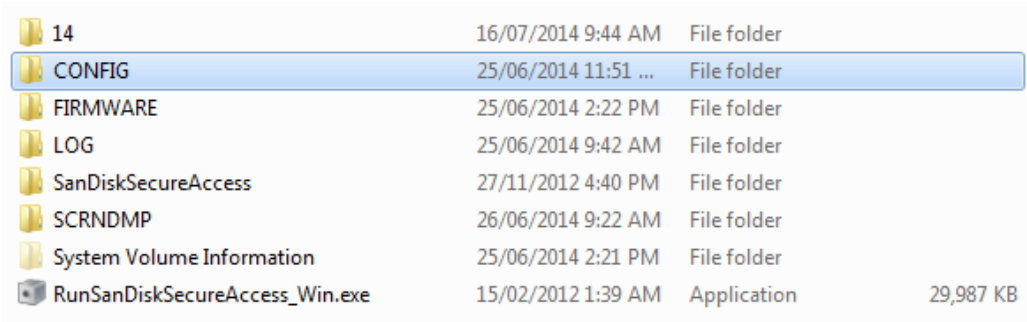

14	16/07/2014 9:44 AM	File folder	
CONFIG	25/06/2014 11:51 ...	File folder	
FIRMWARE	25/06/2014 2:22 PM	File folder	
LOG	25/06/2014 9:42 AM	File folder	
SanDiskSecureAccess	27/11/2012 4:40 PM	File folder	
SCRNDMP	26/06/2014 9:22 AM	File folder	
System Volume Information	25/06/2014 2:21 PM	File folder	
RunSanDiskSecureAccess_Win.exe	15/02/2012 1:39 AM	Application	29,987 KB

Figure 64 – USB Memory Stick File Structure

10. Insert the USB memory stick into your PC/Laptop computer and access the files.
11. Best practice is to email all the on the USB memory stick but if it's too large just send:
12. The CONFIG***.CFG and PARAM***.TXT files that are saved in the CONFIG folder.
13. The LOG files (Event Log text files) and data files (14=Year, Sub folder=month).
14. Safely Eject the USB from the PC/Laptop and return to the instrument.

8. Optional Extras

This section contains information on optional kits and installed options.

Dual Sample Filter	Refer to Section 8.1.
Network Port	Refer to Section 8.2.
Rack Mount Kit	Refer to Section 8.3.
Internal Pump	Refer to Section 8.4.
Metric Fittings Kit	Refer to Section 8.5.
High Pressure Zero/Span Valves	Refer to Section 8.6.
Trace Level Instrument	Refer to Section 8.7.

8.1 Dual Sample Filter (PN: E020100)

The dual filter is designed with two sample filters plumbed in parallel with a split line. This formation allows sample flow not to be affected, yet reduces the loading on each filter and therefore, the frequency with which they will need to be changed.

The dual filter option is shown in the pneumatic diagram (dashed line) and requires no operational changes to the instrument (refer to section 9.5).

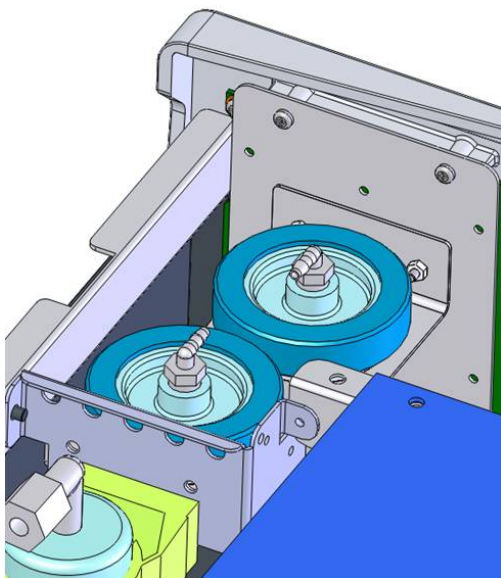

Figure 65 – Dual Filter Option Installed

8.2 Network Port (PN: E020101)

The network port option allows the user to setup and connect to a range of TCP/IP network options. If you have this option installed you need to make sure it is enabled in the **Hardware Menu** before the feature can be used.

- Refer to Section 3.4.29, for details on the network menu.
- Refer to Section 4.3, for details on network setup.

8.2.1 Hardware Setup

This procedure will need to be followed after a factory reset.

Procedure

1. Press - (the green instrument status light button), this will take you to the home screen.
2. Press - (-99+) on the keypad. This will open the **Advanced Menu**.
3. Open - **Advanced Menu** → **Hardware Menu**.
4. Enable - **Network Port** → **Enabled**.

8.3 Rack Mount Kit (PN: E020116)

The rack mount kit is necessary for installing the Serinus into a 19" rack (the Serinus is 4RU in height).

Table 8 – Included Parts (Rack Mount Kit)

Description	Quantity	Part Number
Rack Slide Set	1	H010112
Rack Mount Adaptors	4	H010133
Rack Mount Ears	2	H010134
Spacers	4	HAR-8700
M6 x 20 Button Head Screws	8	
M6 Washers	16	
M6 Nyloc Nuts	8	
M4 x 10 Button Head Screws	18	
M4 Washers	8	
M4 Nyloc Nuts	8	
M6 Cage Nuts	8	

Installing the Instrument

1. Remove the rubber feet from the instrument (if attached).
2. Separate the slide rail assembly by pressing the black plastic clips in the slide rails to remove the inner section of the rail.

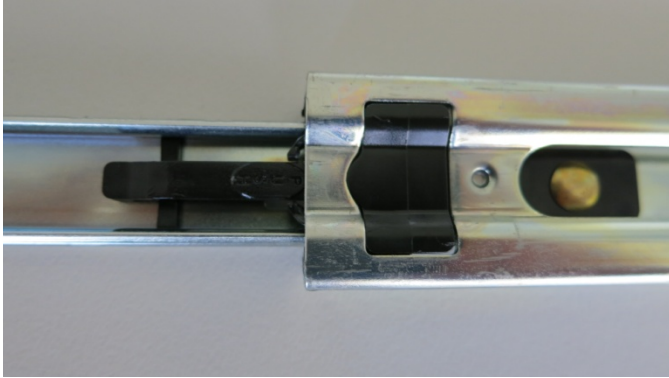

Figure 66 – Separate Rack Slides

3. Attach the inner slide rails to each side of the instrument using M4 x 10 button screws; three on each side (refer to Figure 67).



Figure 67 – Assemble Inner Slide on Chassis

4. Install rack mount ears on the front of the instrument using two M4 x 10 screws on each side (refer to Figure 68).



Figure 68 – Rack Mount Ears Fitted to Instrument

5. Attach the rack mount adaptors to the ends of the outer slide rails using M4 x 10 button screws, washers and locknuts. Do not fully tighten at this stage as minor adjustments will be required to suit the length of the rack (refer to Figure 69).



Figure 69 – Attach Rack Mount Adaptors to Outer Slides

6. Test fit the rack slide into the rack to determine the spacing of the rack mount adaptors.



Figure 70 – Test Fit the Rack Slide Assembly into the Rack

7. Install the two assembled outer slide rails onto the left and right side of the rack securely with M6 bolts; washer and locknuts/cage nuts (refer to Figure 71).

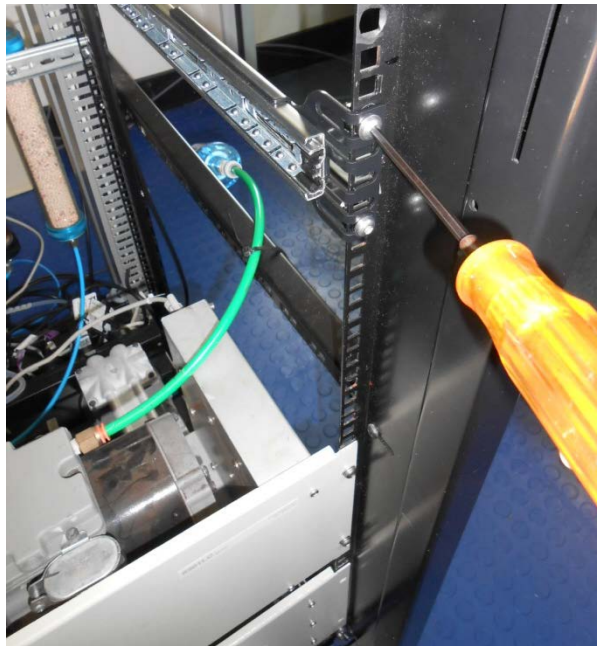

Figure 71 – Attach Slides to Front of Rack

8. Now carefully insert the instrument into the rack by fitting the instrument slides into the mounted rails. Ensuring that the rack slide locks engage on each side.



CAUTION

When installing this instrument ensure that appropriate lifting equipment and procedures are followed. It is recommended that two people lift the instrument into the rack due to the weight, unless proper lifting equipment is available.

Note: Ensure both sides of the inner slide are attached to the outer slides before pushing into the rack fully.

9. Push the instrument into the rack. Adjust and tighten the screws as required to achieve a smooth and secure slide.

To Remove the Instrument

1. To remove the instrument first pull instrument forward of rack giving access to the slides.
2. Find the rack slide lock labelled **Push** and push it in whilst sliding the instrument out of the rack, complete this for both sides while carefully removing instrument.

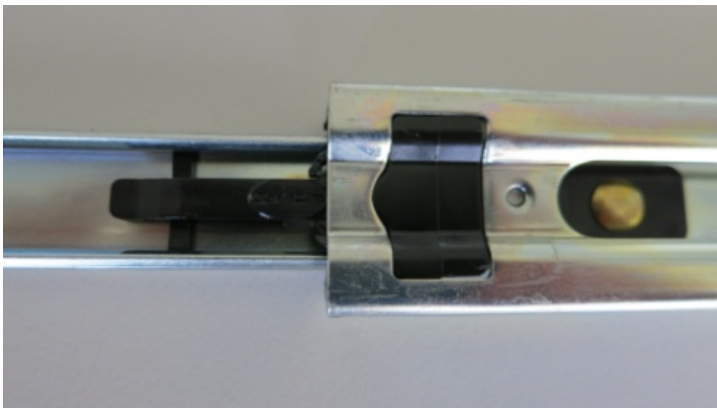

Figure 72 – Slide Clips

8.4 Internal Pump (PN: E020107)

8.4.1 Hardware Setup

This procedure should be followed after a factory reset.

Equipment Required

- NA

Procedure

1. Press - (the green instrument status light), this will take you to the home screen.
2. Press - (-99+) on the keypad. This will open the **Advanced Menu**.
3. Open - **Advanced Menu** → **Hardware Menu**.
4. Enable - **Internal Pump** → **Enabled**.

8.4.2 Internal Pump Additional Components

The Serinus 30 internal pump option includes the following additional components:

Table 9 – Internal Pump Additional Components

Component	Description	Part number
Internal pump	Draw sample through the instrument	H010027
Flow block	Includes sintered filter and differential pressure sensor to measure flow.	H010120
Heater and Thermistor	Mounted in flow block to measure and control temperature for accurate flow measurement.	Installed in flow block

8.4.3 Internal Pump Removed Components

The Serinus 30 has a number of components missing from the standard instrument due to the presence of the internal pump and flow block controlling flow within the instrument. The parts that have been removed when this option is installed are listed in the table below.

Table 10 – Internal Pump Removed Components

Component	Part number
Sintered filter	F010004
O-ring	O010012
Spring	H010040
O-ring	O010013
Orifice	H010043-13

8.4.4 Pressure Calibration Internal Pump Option

The internal pump requires a separate modified procedure to allow the internal pump to generate the necessary vacuum (refer to Section 5.3).

8.4.5 Flow Calibration

The flow calibration menu is only available when the internal pump option is installed (refer to Section 3.4.12).

The internal pump requires a separate flow calibration procedure. The flow calibration detailed in Section 5.9 must be performed after any pump service or pressure calibration.

8.4.6 Internal Pump Leak Check

The internal pump requires a separate modified procedure to leak check the system (refer to Section 6.3.4.1).

8.4.7 Pump Control

This section describes how to turn off and on the internal pump for servicing and maintenance purposes.

Procedure

1. Open - **Main Menu** → **Service Menu** → **Diagnostics Menu** → **Internal Pump Menu**.
2. Select - **Flow Control** → **Manual**.
3. Toggle Off - **Internal Pump** → Off.

8.5 Metric Fittings Kit (PN: E020122)

The metric fittings kit allows the user to connect 6 mm tubing to the rear ports of the analyser. This can be very handy if it is hard to source ¼” tubing from a local supplier.

8.6 High Pressure Zero/Span Valves

High pressure span calibration valve (factory installed (PN: E020108))

High pressure zero calibration valve (factory installed (PN: E020109))

For more information on how to setup and use the high pressure valves refer to section 5.10.

Please refer to Section 9.11 for the exploded assembly drawing.

Note: Before using a high pressure span or zero as a source for calibrating the instrument, please check your local regulatory requirements.

8.7 Trace Level Instrument (PN: E020127)

The trace option enables the instrument to detect levels carbon monoxide (CO) from 0-20,000 ppb with a lower detectable limit of 20 ppb. This allows the Serinus 30 Trace to sample in the most useful range for CO background measurement (25-500 ppb CO in air, levels that represent the range of global CO mixing ratios in the unpolluted atmosphere).

The Serinus 30 Trace has a number of extra passes in the measurement cell to increase the resolution, along with a thermally stabilised detector housing with a more sensitive IR detector operating at a lower temperature (-50 °C) to reduce thermal noise.

This option is also available without a dryer (PN: E020120).

8.7.1 Trace Specifications

The following tables list the changes to a standard instrument with the trace option installed.

Table 11 – Trace Parts Removed

Parts Removed	Quantity	Part Numbers
Measurement Cell	1	H014100

Table 12 – Trace Parts Added

Parts Added	Quantity	Part Number
Trace Measurement Cell	1	H014100-02
Dryer	1	H014180

8.7.2 Measurement

Range

0-20 ppm autoranging

Lower detectable limit: 20 ppb, with Kalman filter active

8.7.3 Precision/Accuracy

Noise at Zero

<10 ppb

8.7.4 Calibration

Zero Drift

24 hours: < 50 ppb

Span Drift

24 hours: 1 % of reading or 50 ppb whichever is greater

8.7.5 Trace setup

Sighting and System Setup

The sensitivity of the Serinus 30 trace requires special materials to be used for all measurement path lines. These materials must be inert to the pollutant being measured as shown below.

- Sample Column: The Sample Column should be made of glass to prevent reactions with air drawn into column.
- Sample Hood: The Sample Hood should be made of Teflon, ensuring that there is no sample retention.
- Lines: All sample transport tubing, including zero and calibration lines, must be made of virgin Teflon, PTFE or FEP.
- Regulator: A High purity, stainless steel dual stage regulator should be used.
- Stainless steel chromatography grade 1/8 gas lines should be used to connect span gas cylinder to gas dilution device.
- Calibration should be carried out by flooding the sample manifold with 10-20 l/m of calibration gas. This method ensures that all sample gas contact areas are exposed to the calibration gas.

- Zero calibrations should also involve flooding with zero gas at 10-20 l/m
- Sample gas residence time in the manifold should be less than 3.5 seconds.

Instrument

A standard Serinus 30 draws ambient air from within its localised area when performing a background while when sampling it draws the sample from a sample manifold. The difference between air sources (sample and background) may alter readings on a trace level instrument. Trace instruments can detect these slight differences so background and sample air must be drawn from an identical source. The trace instruments obtain background air from the same source as the sample air, helping standardise air samples and eliminating potential differences such as humidity.

- Connect ¼ inch virgin PTFE FEP tubing between the sample manifold and the sample inlet on the instrument.
- Connect ¼ inch virgin PTFE FEP tubing from the BGnd Air Port to the sample manifold. Or if no ports are available on the sample manifold add a tee connection with the tubing going to the sample inlet on the instrument.

8.7.6 Trace Operation

Please refer to Section 9.5 for a detailed pneumatic diagram.

Pneumatics

A standard Serinus 30 instrument uses calibration valves to supply sample, span and zero air to the inlet. The small error created from delivering gas through different lines is not measurable in standard instruments but can offset results in a trace level instrument. To eliminate this difference the zero and span gas is flooded directly into the sample manifold (the manifold pump or fan is disabled and isolated with a valve) to a point where it fills the entire manifold and overflows preventing any ambient external air from entering. Thus the manifold inlet now becomes the calibration vent. The air within the manifold is then drawn through the instrument where measurements can be taken and compared to the concentration being delivered by the calibration system.

8.7.7 Trace Default Values

The Serinus 30 Trace default parameters vary from the Serinus 30 standard setup. The following is a list of differing parameters and their new default/expected values.

Table 13 – Trace Parameter Value Changes

Parameter	Default Value
Cooler Pot	255
Cooler Voltage	2.0 V

8.7.8 Trace Calibration Guidelines

To perform a multipoint calibration follow the procedure outlined in Section 5.8 for general setup, some aspects of calibration need more attention to detail. These following steps detail some of the changes in the calibration procedure that must be understood before performing any calibration.

Note: Before commencing a multipoint calibration, perform a manual background with diluted zero air flowing at 10-20 Lpm in the sample manifold.

- Span/Zero gas should be injected directly into the sample manifold with a volume that will flood the manifold preventing any external air from entering and influencing the Span/Zero gas.
- Losses may occur in sample manifold and tubing due to contaminants entering during normal measurement cycle. Flooding the sample manifold and tubing with zero air can help clean these contaminants out.
- The instrument must be powered up and in normal measurement calibration mode (ie all gas lines are attached and ready for use) for up to 48 hours before a calibration can be performed.

Note: A 48 hour preconditioning is necessary to warm-up materials and ensures that the instrument is working at its optimum when the calibration is performed. This preconditioning is particularly important for trace instrument calibrations due to the sensitive nature of the measurements.

- The Serinus 30 Trace must be used in a laboratory environment which includes air conditioning to stabilise the temperature.
- A zero test should be performed over a 24 hour period to get an accurate reading of the Lowest Detectable Limit (LDL) of the entire system installation. Throughout this time period ten minute intervals should be used to collect readings of the CO from the zero air. From the data acquired the smallest detectable signal that can be accurately measured is found as well as the noise which determines the stability and precision of readings.
- A shut off valve should be designed into the sample manifold system, whereby the fan or pump used to draw in the sample air is turned off and the valve isolates the fan or pump from the sample manifold, when a calibration is in process (as ambient air is not required for calibration and will make calibration void). This valve can be controlled manually or via the data logger providing the data logger is designed with this function.

8.7.9 Trace Service and Maintenance

The maintenance intervals are determined by compliance standards that differ in various regions. The following is recommended by Ecotech as a guide. Compliance with local regulatory or international standards is the responsibility of the user. The below list only includes items that are different to a standard range instrument.

Table 14 – Maintenance Schedule

Interval *	Task performed	Section
Monthly	Replace particulate filter	6.3.1
	Check sample inlet system for moisture or foreign materials and clean	

6 Monthly	Perform multipoint precision check	8.7.8
-----------	------------------------------------	-------

* Suggested intervals for maintenance procedure are a guide only and may vary with sampling intensity and/or environmental conditions. Please refer to your local regulatory standard for your personalised maintenance schedule.

9. Parts List and Schematics

9.1 Serinus Accessories Kit

This kit contains assorted fittings, tubing and an orifice removal tool which are useful when working on the instruments internal pneumatics. This is usually purchased with the instrument.

Table 15 – Serinus Accessories Kit – (PN: H010136)

Part Description	Quantity	Part Number
Kynar Union Tee Fitting	4	F030007
Kynar Union Fitting	2	F030008
Adapter, 1/4" Fitting to 1/8" Barb	4	H010007
Adapter, 1/4" Tube to 1/8" Barb	2	H010008
Orifice Extraction Tool	1	H010046
Ecotech Tygon Tubing (1/4" OD, 1/8" ID (Clear))	3 Feet	T010011
Neoprene Tubing (1/4" OD, 1/8" ID (Black))	3 Feet	T010021

9.2 Maintenance Kit

This maintenance kit is required when performing annual maintenance on the instrument. Depending on the environment the instrument is operating, this maintenance may need to be carried out more often than yearly.

Table 16 – Serinus 30 Maintenance Kit – (PN: E020202)

Part Description	Part Number
Stainless Steel Sintered Filter	F010004
23 Micron DFU	F010005
Viton O-Ring	O010008
O-Ring (0.364 ID X 0.070 W)	O010010
Viton O-Ring (0.114 ID X 0.07 W)	O010012
O-Ring (5/32 ID X 1/16 W (BS007))	O010013
Viton O-Ring (1 11/16 ID X 3/32 W)	O010014
Viton O-Ring (1/4 ID X 1/16 W)	O010015
Viton O-Ring (13/16 ID X 1/16 W)	O010016
Viton O-Ring (BS015)	O010023
O-Ring (BS110)	ORI-1009
Ecotech Tygon Tubing (1/4" OD, 1/8" ID (Clear))	T010011

9.3 Consumables

Parts shown as consumables below will require replacement over the course of the instrument's lifespan.

Table 17 – Serinus 30 Consumables

Part Description	Part Number
47 mm, 5 micron, Teflon Filter Paper, Pack of 50	F010006-01
47 mm, 5 micron, Teflon Filter Paper, Pack of 100	F010006
CO-CO2 Converter	H014130
#14 Orifice – Used In The Measurement Cell	H010043-13
Stainless Steel Sintered Filter	F010004
23 Micron DFU	F010005
External Pump Repair Kit (To Suite a 607 Pump)	P031001
Internal Pump Repair Kit (to suit KNF Pump)	P031005
Ecotech Tygon Tubing, 25 ft Length	T010011-01

***Warranty Disclaimer:** The product is subject to a warranty on parts and labour from date of shipment (the warranty period). The warranty period commences when the product is shipped from the factory. **Lamps, fuses, batteries and consumable items are not covered by this warranty.** Subject to variable ambient conditions, toxic gases, dirt, extremes of temperature and moisture ingress may shorten the lifespan of components.

9.4 Instrument Parts List

List of Serinus 30 components and part numbers for reference:

Table 18 – Spare Parts List Serinus 30

Part Description	Part Number
Main Controller PCA	E020230-01
Serinus Power Supply, Auto-ranging	P010013
Measurement Cell Assembly	H014100
Infrared Source	H014201
Narrow-Bandpass Filter	H014205
Detector PCA	C010009
Detector	S030005
Pressure Sensor PCA	C010004
Pressure Sensor Gasket	H010037
Source Timing Assembly	H014125
Motor Assembly	M020006

Part Description	Part Number
Correlation Wheel Assembly	H014114
Optical Interrupter	S030002
Measurement Cell Heater, Thermister Assembly	C020073
Sapphire Window	H014206
Spring Compression Used in The Measurement Cell	H010040
#14 Orifice Used in The Measurement Cell	H010043-13
Sintered filter	F010004
Gasket For Measurement Cell	H014212
Front Panel Assembly	H010130
Serinus 30 Label For Front Panel Assembly	H010132-03
Rear Panel PCA	C010002
Calibration Valve Manifold Assembly	H010013-01
CO-CO2 Converter Assembly	H014130
Thermal Fuse and Heater Thermister Assembly – CO to CO ₂ converter	C020082
Silicone Heat Sink Compound	C050013
Sample Filter Holder Assembly	H010020
Fan For Rear Panel	C020058
Fan Filter Kit for Rear Panel Fan	H010044
Barb Adaptor	H010007
Fitting Kynar Bulkhead	F030023
O-Ring, Flat and Spherical Mirrors	O010011
O-Ring, Mounting Plate	O010009
Internal Pump Assembly Spare Part (KNF Pump)	H010027
Internal Pump Repair Kit (to suit KNF Pump)	P031005
External Pump (607 Pump) 240 VAC	P030004
External Pump (607 Pump) 110 VAC	P030005
External Pump Repair Kit (To Suite a 607 Pump)	P031001
Extraction Tool, Sintered Filter and Orifice	H010046
Minifit Extraction Tool	T030001
Serinus 30 User Manual	M010027
USB Memory Stick	H030021

9.5 Plumbing Schematic – (PN: D020005)

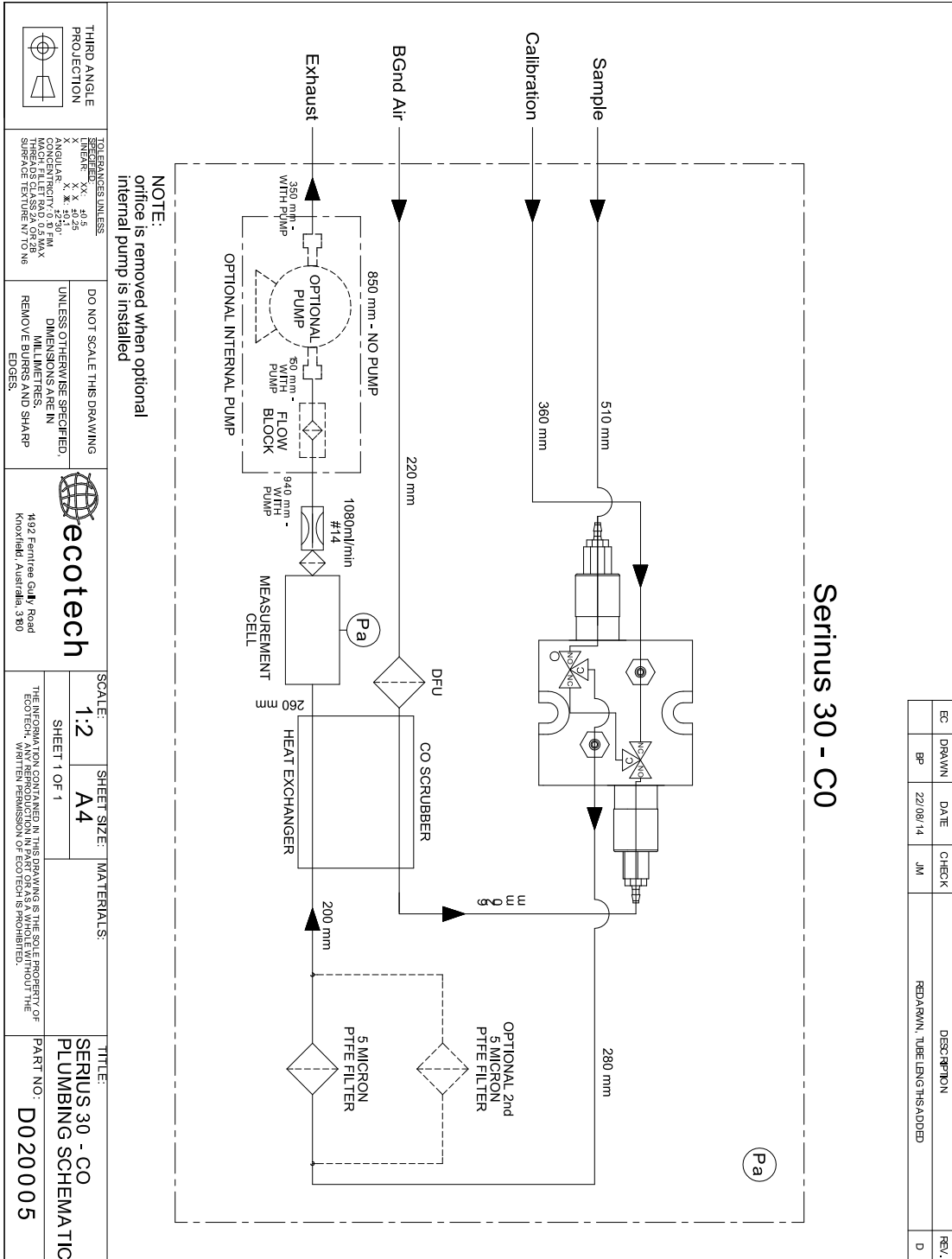

9.6 Trace Plumbing Schematic – (PN: D020066)

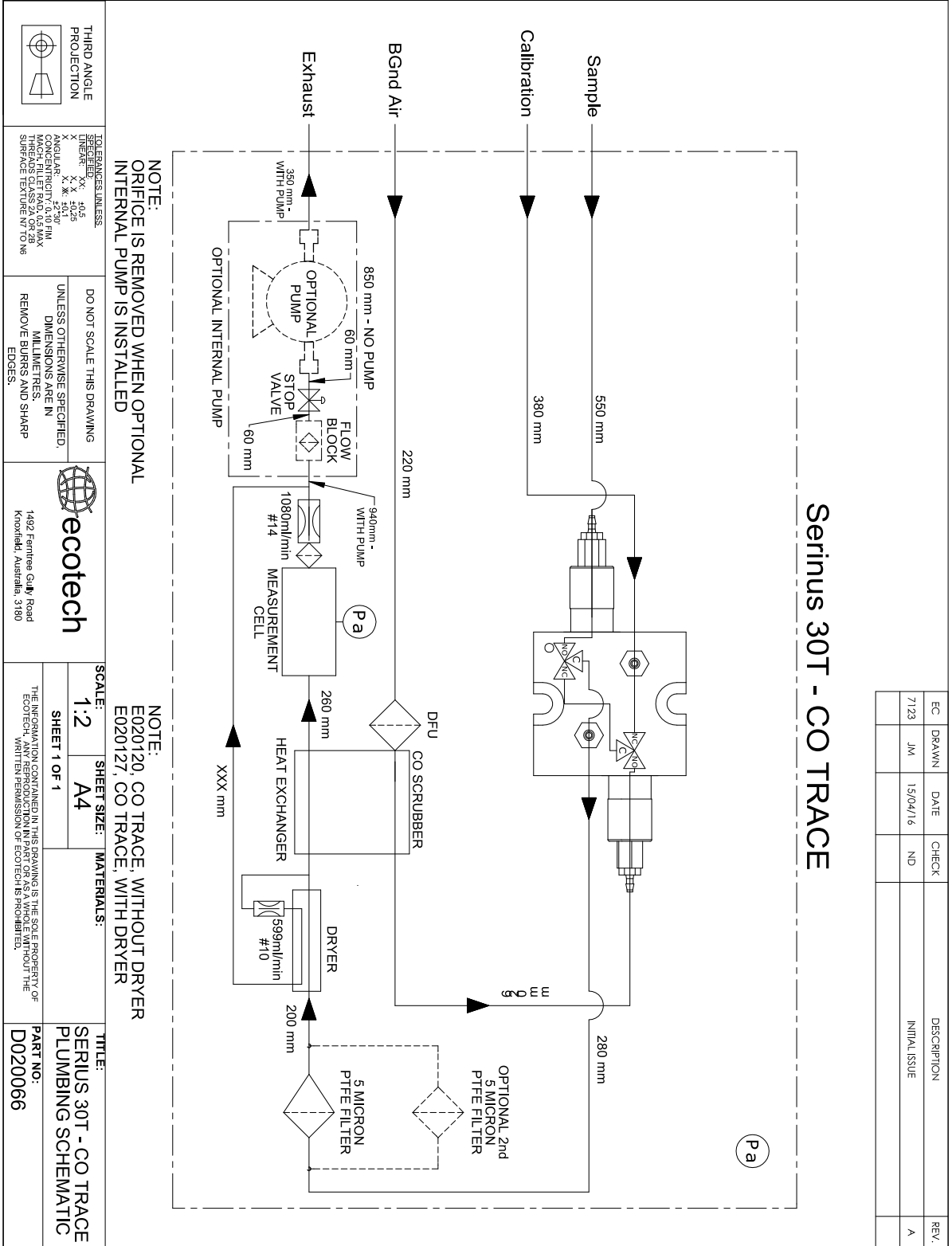

9.7 Block Wiring Schematic – (PN: D020102)

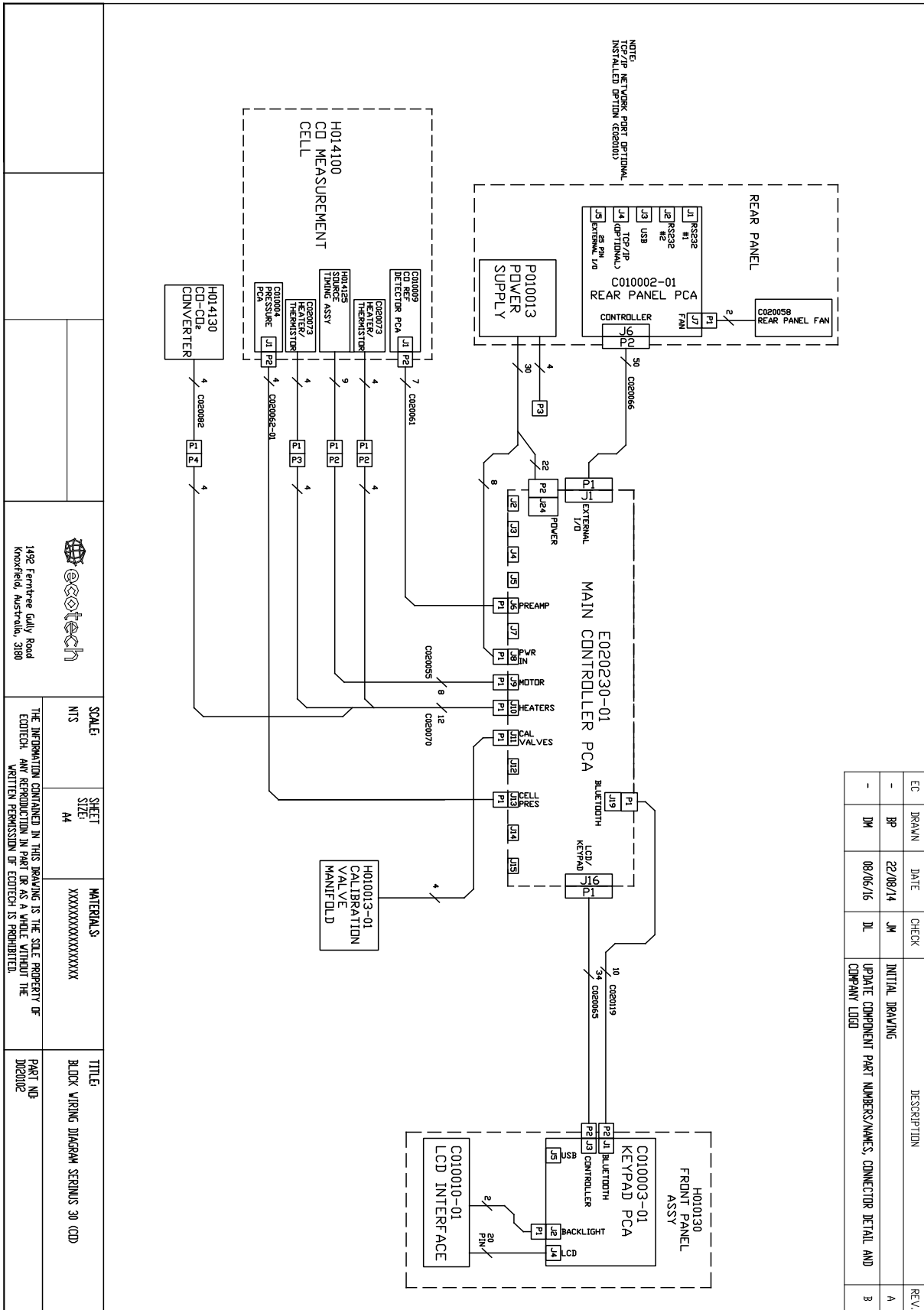

EC	DRAWN	DATE	CHECK	DESCRIPTION	REV.
-	BP	22/08/14	JM	INITIAL DRAWING	A
-	JM	08/06/16	DL	UPDATE COMPONENT PART NUMBERS/NAMES, CONNECTOR DETAIL AND COMPANY LOGO	B



1492 Fernvale Gully Road
Knoxfield, Australia, 3180

SCALE: MTS
SHEET SIZE: A4
MATERIALS: XXXXXXXXXXXXXXXXXXXX

TITLE: BLOCK WIRING DIAGRAM SERINUS 30 (CD)
PART NO: D020102

THE INFORMATION CONTAINED IN THIS DRAWING IS THE SOLE PROPERTY OF EOTECH. ANY REPRODUCTION IN PART OR AS A WHOLE WITHOUT THE WRITTEN PERMISSION OF EOTECH IS PROHIBITED.

9.8 CO Cell Assembly – (PN: H014100)

ITEM NO.	PART NUMBER	DESCRIPTION	QTY.
1	H014110	CO CELL B.A.S.C. ASSY	1
2	H014206	WINDOW SA PHILLIPS X 2.5	1
3	O010008	SEAL RING 3/20	1
4	C010004	PCA PRESSURE CHLORIDE GAS	1
5	F050010	M3X10 STAINLESS PAN HEAD PHILLIPS SCREW	7
6	F050006	HEX SPACER M3 X 10MM, 5MM STUD BRASS NICKLE PLATED MALE/ FEMALE	4
7	C010009	PCA CO DETECTOR GAS	1
8	F050024	M3X6 STAINLESS PAN HEAD PHILLIPS SCREW	4
9	F050011	M3X6 STAINLESS PAN HEAD PHILLIPS SCREW	4
10	H010037	GASKET PRESSURE SENSOR	1
11	H014103	COVER CORRELATION	1
12	H014125	MOTOR WHEEL LAMP ADAPTOR HEAD & CO. FIBER OPTIC WIRE & SCRY O-RING 0.3640 X 0.070W, 89012 VITON	1
13	O010010	O-RING 0.3640 X 0.070W, 89012 VITON	1
14	H014106	ADAPTOR SENSOR TO CELL	1
15	H014205	FILTER INFRARED CO BRAND	1
16	S030005	DETECTOR LEAD SELENIDE +65°C	1
17	FAS.M3BS-5	M3X6 BUTON HEAD SCREW	2
18	FAS.M3SS-12	M3X12 CSK SCREW, HEX DRIVE	2
19	H014126	COVER SENSOR CO	1
20	F050012	M3X10 STAINLESS PAN HEAD PHILLIPS SCREW	3
21	F030023-NO CAP	HITTING UNION 1/4" X 1/16W, O-RING 5/32X1/16W, VITON	2
22	O010012	O-RING 1/4" X 1/16W, VITON	2
23	H010043-13	ADAPTOR 1/4" HITTING UNION	1
24	H010007	O-RING 1/8" X 1/16W, VITON	1
25	O010009	PHILLIPS SCREW	1
26	F010004	SPRING COMPRESSION, 0.24 DIA 0.630 MM WIRE	1
27	H010040	HITTING UNION 1/4" X 1/16W	1
28	CAP	UNION 1/4" X 1/16W	1
29	H014212	COVER GASKET	1
30	H014211	COVER BLATE	1

EC	DRAWN	DATE	CHECK	DESCRIPTION	REV.
6982	V.C.	29/03/08	D.C.	INITIAL DRAWING	A
	V.C.	31/03/10	J.M.	PART NUMBERING, DIMENSIONS & ASSEMBLY	B

THIRD ANGLE PROJECTION	UNITS: X, Y, Z IN; X, Y, Z MM; ANGLES: DEGREES	DO NOT SCALE DRAWINGS	ECOTECH Environmental Monitoring Solutions	SCALE: AS	SHEET SIZE: A3	TITLE: CO CELL FINAL ASSEMBLY, SERINUS

9.9 Source Timing Assembly – (PN: H014125)

EC	DRAWN	DATE	CHECK	DESCRIPTION	REV.
-	V.C.	15/01/08	M.S.	INITIAL DRAWING	A
6962	VC	6/4/10		PART NUMBER UPDATED AS PER NEW PART NUMBERING SYSTEM	B
BP		22/08/2014	JM	PART NUMBER UPDATED	C

ITEM NO.	PART NUMBER	DESCRIPTION	QTY.
1	H014102	ADAPTOR PLATE, MOTOR AND CORRELATION WHEEL	1
2	H014201	SOURCE ASSY CLEANED / BURNED-IN	1
3	H014104	SHAFT, MOTOR, CORRELATION WHEEL	1
4	S030002	OPTO. SENSOR, SLOTTED SERINUS	1
5	H014114	CORRELATION WHEEL, CO	1
6	M020006	MOTOR 12V	1
7	FASM-3BS-2	M3 X 5 GRUB SCREW / KNURLED CUP POINT	2
8	F050010	M3X10 SEMI-SPAN HEAD PHILLIPS SCREW	6
9	F050011	M3X6 SEMI-SPAN HEAD PHILLIPS SCREW	1

THIRD ANGLE PROJECTION	TOLERANCES UNLESS SPECIFIED:	DO NOT SCALE THIS DRAWING	UNLESS OTHERWISE SPECIFIED, DIMENSIONS ARE IN MILLIMETERS. REMOVE BURRS AND SHARP EDGES.	 1492 Fernside Gully Road Knoxfield, Australia, 3180	SCALE: 1:2 SHEET SIZE: A4 SHEET 1 OF 2	MATERIALS: .. TITLE: SOURCE TIMING ASSLY	PART NO: H014125
-------------------------------	-------------------------------------	----------------------------------	---	--	---	---	-------------------------

9.10 Calibration Manifold Assembly – (PN: H010013-01)

EC	DRAWN	DATE	CHECK	DESCRIPTION	REV.
	VC	16/03/10		INITIAL DRAWING	X1
	BP	22/09/2014	JM	BOM ADDED	8

VALVE 1
CABLE LENGTH 190 mm
CONNECT TO PINS 1 AND 6
ON THE CONNECTOR

VALVE 2
CABLE LENGTH 250 mm
CONNECT TO PINS 2 & 7
ON THE CONNECTOR

CABLE TIE
2-PLACES

MICROFIT RECEPTACLE
FREE 10 WAY MOLEX

1. VALVES MUST BE FREE OF DIRT, GREASE OR ANY OTHER FOREIGN MATERIAL
2. 18230-J1A THREADS MUST BE SEALED WITH SWAGelok THREAD TAPE
3. MANIFOLD BLOCK MUST BE FREE OF DIRT GREASE OR ANY OTHER FOREIGN MATERIAL
4. ASSEMBLY MUST PASS LEAK TEST UNDER VACUUM OF -90 KPA, MAX DROP ALLOWED IS 2 KPA IN 5 MINS.

ITEM NO.	PART NUMBER	DESCRIPTION	QTY.
1	H010014-01	VALVE/MANIFOLD	1
2	H010042	VALVE MFLD, 3 WAY, 12VDC	2
3	H030006	FITTING, MALE CONNECTOR 1/8NPT - 1/8 BARB, KNMAR	4

THIRD ANGLE PROJECTION 	DIMENSIONS UNLESS SPECIFIED: DIMENSIONS ARE IN MILLIMETERS UNLESS OTHERWISE SPECIFIED REMOVE BURRS AND SHARP EDGES	SCALE: NTS SHEET 1 OF 1	MATERIALS: AS NOTED	TITLE: CALIBRATION VALVE MANIFOLD PART NO: H010013-01
-----------------------------------	---	--------------------------------------	-------------------------------	--

9.11 Valve Assembly – (PN: H010042)

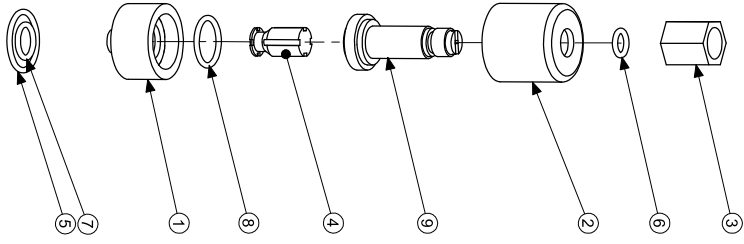

ITEM NO.	PART NUMBER	QTY.
1	BODY	1
2	SOLENOID COIL	1
3	NUT	1
4	PLUNGER	1
5	O010016	1
6	O010015	1
7	O010010	1
8	O010023	1
9	Stem	1

STEPS TO REPLACE O-RINGS

1. MARK THE SOLENOID COIL WITH A PERMANENT MARKER TO IDENTIFY THEIR RESPECTIVE VALVES AND THEIR POSITION ON MANIFOLD BLOCK
2. SECURE THE 3-WAY VALVE UPRIGHT INTO A LARGE VICE WITH PROTECTION AROUND ITS BODY TO PREVENT SCRATCH OR DAMAGE TO VALVE
3. REMOVE NUT FROM THE TOP OF THE 3-WAY VALVE USING A 9/16" SPANNER
4. REMOVE SMALL O-RING FROM AROUND 3 WAY VALVE USING 2 MM FLAT SCREW DRIVER
5. LIFT OFF THE SOLENOID COIL FROM THE 3-WAY VALVE THEN UNCREW THE SHAFT FROM THE BASE USING A LARGE FLAT SCREW DRIVER
6. WHILE UNSCREWING TAKE CARE THAT THE INTERNAL PLUNGER DOES NOT FALL OUT
7. REPLACE THE INTERNAL O-RING WITH O010023
8. ASSEMBLE THE SHAFT ALONG WITH PLUNGER BACK IN ITS POSITION
9. ASSEMBLE THE SOLENOID WITH ITS RESPECTIVE VALVE
10. ASSEMBLE NEW O010015 O-RING SUPPLIED
11. ASSEMBLE THE NUT ON TOP OF 3-WAY VALVE
12. ASSEMBLE O010016 AND O010010 O-RINGS ON THE BOTTOM OF THE VALVE ASSEMBLY VALVE BACK IN MANIFOLD BLOCK

9.12 High Pressure Valve Exploded View – (PN: H050043)

EC	DRAWN	DATE	CHECK	DESCRIPTION	REV.
	JM	04/12/2015	ND	INITIAL ISSUE	A

INSTRUMENT TYPE	ORIFICE PART NO.
S10 (O3)	H010043-09
S30/S31 (CO / CO2)	H010043-13
S40 (NOx)	H010043-11
S40H (NOx HIGH LEVEL)	H010043-03
S44 (NH3/NOx)	H010043-11
S5X (SO2, H2S/SO2, H2S, TS, TRS)	H010043-13

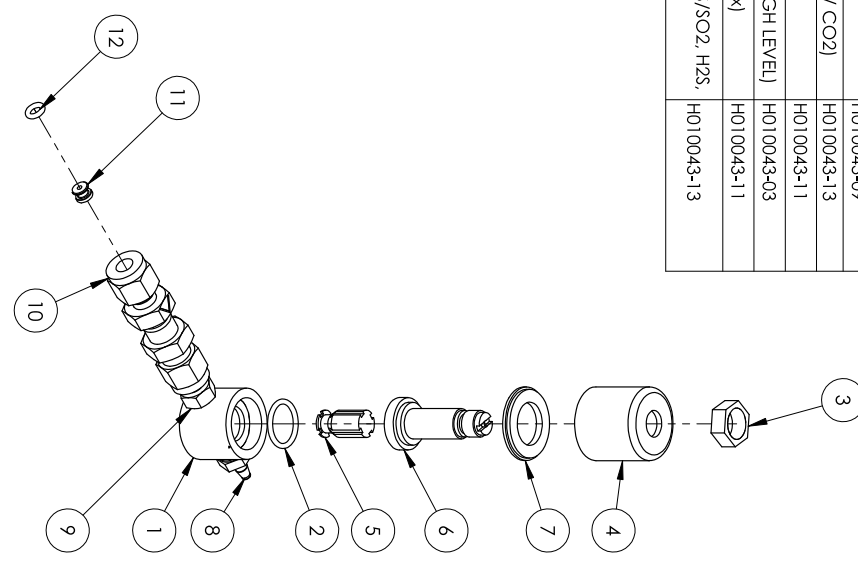

ITEM NO.	PART NUMBER	DESCRIPTION	QTY.
1	BASE	BASE, VALVE, 2 WAY, 12 VDC	1
2	O010023	O-RING BS038, SILICONE	1
3	NUT	NUT, VALVE, 2 WAY, 12 VDC	1
4	COIL	SOLENOID COIL, VALVE, 2 WAY, 12 VDC	1
5	PLUNGER	PLUNGER, VALVE, 2 WAY, 12 VDC	1
6	STEM	STEM, VALVE, 2 WAY, 12 VDC	1
7	WASHER	WASHER, VALVE, 2 WAY, 12 VDC	1
8	F030006	FITTING, MALE CONNECTOR 1/8NPT - 1/8 BARB, KYNAR	1
9	28590462-3	Male Adapter (Tapped Thread)	1
10	98300076	FITTING, BULKHEAD, 1/4T S/S, MODIFIED	1
11	H010043-XX	ORIFICE	1
12	O010013	O-RING 5/32ID X 1/16W, VITON	1

THIRD ANGLE PROJECTION	TOLERANCES UNLESS SHOWN: DIMENSION: X, X, X ANGULAR: X, X, X CONCENTRICITY: X, X SURFACE TEXTURE: IV TO IAS	DO NOT SCALE THIS DRAWING UNLESS OTHERWISE SPECIFIED, DIMENSIONS ARE IN MILLIMETERS AND SHARP EDGES.	 1492 Fernitee Gulf Road Knoxfield, Australia, 3180	SCALE: 1:2 SHEET 1 OF 1	MATERIALS: AS PER BOM	TITLE: VALVE ASSY - HIGH PRESSURE; SERINUS
-------------------------------	--	--	---	--------------------------------------	---------------------------------	--

THE INFORMATION CONTAINED IN THIS DRAWING IS THE SOLE PROPERTY OF ECOTECH. NO PART OF THIS DRAWING IS TO BE REPRODUCED OR TRANSMITTED IN ANY FORM OR BY ANY MEANS, WITHOUT PERMISSION OF ECOTECH IS PROHIBITED.

S:\ECOTECH\ENGINEERING\CAD\H05

This page is intentionally blank

Appendix A. Advanced Protocol

The Advanced protocol allows access to the full list of instrument parameters.

A.1 Command Format

All commands and responses sent to and from the Instrument will be in the following packet format to ensure data is reliable.

Table 19 – Packet Format

1	2	3	4	5	6 ... 5+n	6+n	7+n
STX (2)	Serial ID	Command	ETX (3)	Message Length (n)	Message	Checksum	EOT (4)

Where:

<STX> ASCII Start of Text = 0x02 hex.

Serial ID The Serial ID assigned in the **Main Menu** → **Communications Menu** → **Serial Communication Menu**.

<ETX> ASCII End of Text = 0x03 hex.

Checksum The XOR of the individual bytes except for STX, ETX, EOT and Checksum.

Message length Must be in the range 0 to 32. Responses from the instrument can have a message Length of 0 to 255.

<EOT> ASCII End of Transmission = 0x04 hex.

Examples

A basic request for Primary gas data would be as follows:

Table 20 – Example: Primary Gas Request

Byte Number	1	2	3	4	5	6	7	8
Description	STX	ID	Command	ETX	Message Length	Primary Gas Conc	Checksum	EOT
Value	2	0	1	3	1	50	50	4
Checksum Calculation		0	0⊕1=1		1⊕1=0	0⊕50=50	50	

And a sample response:

Table 21 – Example: Primary Gas Response

Byte Number	1	2	3	4	5	6	Continued in next table.
Description	STX	ID	Command	ETX	Message Length	Primary Gas Conc	
Value	2	0	1	3	5	50	
Checksum Calculation		0	$0 \oplus 1 = 1$		$1 \oplus 5 = 4$	$4 \oplus 50 = 54$	

Table 22 – Example: Primary Gas Response (continued)

Byte Number	7	8	9	10	11	12
Description	IEEE representation of 1.00				Checksum	EOT
Value	63	128	0	0	50	4
Checksum Calculation	$54 \oplus 63 = 9$	$9 \oplus 128 = 137$	$137 \oplus 0 = 137$	$137 \oplus 0 = 137$	137	

A.2 Commands

A.2.1 Communication Error

Where:

- Command byte 0
- Message byte 1 0
- Message byte 2 0..7

If the command byte of a response is 0, this indicates an error has occurred. The message field will be 2 bytes long, where the 2nd byte indicates the error according to the following table.

Table 23 – List of Errors

Error #	Description
0	Bad Checksum received
1	Invalid Parameter Length
2	Invalid Parameter
3	Internal Data Flash Erase in Progress unable to return data for a few seconds
4	Unsupported Command.
5	Another process is collecting data – unable to service request.
6	MemStick No Connected
7	MemStick Busy

A.2.2 Get IEEE Value

Where:

- Command byte 1
- Message byte 1 Index from List of Parameters
- Message byte 2..32 Additional indexes (optional)

This command requests the value of an instrument parameter. The message field byte contains the index of the parameter requested, as described in the List of Parameters.

Up to 32 indexes can be supplied in a single request. The response has 5 bytes for each parameter requested – the first byte is the parameter index and the next four are the IEEE representation of the current value.

Example

A request with a message field of 50,51,52 to a Serinus S40 would return a 15 byte message as shown below:

Table 24 – Example: Get IEEE Response data

1	2	3	4	5	6	7	8	9	10	11	12	13	14	15
50	NO reading				51	NOx reading				52	NO2 reading			

A.2.3 Set Calibration Mode

Where:

- Command byte 4
- Message byte 1 85
- Message byte 2-5 The IEEE representation of 0, 1, 2, or 3
 - 0 puts the instrument into Measure mode (0,0,0,0)
 - 1 puts the instrument into Cycle mode (63,128,0,0)
 - 2 puts the instrument into Zero mode (64,0,0,0)
 - 3 puts the instrument into Span mode (64,64,0,0)

This command puts the instrument into a calibration mode (the same as going to the Calibration menu and choosing a Cal. Mode).

Example

A request with a command of 4 and a message field of 85,64,64,0,0 would place the instrument into Span mode.

A.2.4 Set Calibration

Enters a new calibration value: the same as entering Span Calibrate or Zero Calibrate on the calibration menu.

Where:

- Command byte 18
- Message byte 1 0, 1, 2, or 3 where
- 0 = Span
- 1 = Zero (first zero gas)
- 2 = Zero (second zero gas)
- 3 = Zero (Third zero gas)
- Message byte 2-5 The IEEE representation of the calibration value.

A.3 List of Parameters

Note: Parameters are for all Serinus series analysers and may not be applicable to an individual instrument.

Table 25 – Advanced Protocol Parameter List

#	Description	Notes
1	Cal/Zero Valve	0 = Zero, 1 = Cal
2	Internal Span Valve	0 = Off, 1 = On
3	Positive Supply	Positive analog supply voltage
4	Gas 5 Avg.	Average of the readings (for Gas 5) of the last n minutes where n is the averaging period E.g. Nx
5	Pregain	S30H linearization coefficient gain
6	Sample/Cal Valve	0 = Sample, 1 = Cal/Zero
7	NOx Measure Valve	0 = NO, 1 = NOx
8	NOx Bypass Valve	0 = NO, 1 = NOx
9	NOx Backgnd Valve	0 = Off, 1 = On
10	Valve Sequencing	0 = Off, 1 = On
11	LCD Contrast Pot	0 = Lightest, 255 = Darkest
12	SO2 Ref Zero Pot	S50 Reference zero pot
13	CO Input Pot	S30 Input pot
14	CO Reference Test Pot	Not Used
15	CO Measure Pot	Not Used
16	High Volt Adjust Pot	PMT High Voltage Adjust Pot for S50 & S40

17	SO2 Lamp Adjust Pot	S50 Lamp adjustment Pot
18	O3 Lamp Adjust Pot	S10 Lamp adjustment Pot
19	O3 Meas. Zero Pot (C)	S10 Signal zero measure (coarse)
20	O3 Meas. Zero Pot (F)	S10 Signal zero measure (fine)
21	PMT Fan Pot	Optical Bench fan speed control pot
22	Rear Fan Pot	Chassis Fan speed control pot
23	Pump Fine Pot	Internal Pump speed fine pot
24	Pump Coarse Pot	Internal Pump speed coarse pot
25	Analog input 0	SO2 Reference signal
26	Analog input 1	CO Reference signal
27	Analog input 2	O3 Reference signal
28	Analog input 3	SO2 & O3 Lamp current
29	Analog input 4	Flow block pressure
30	Analog input 5	Cell pressure
31	Analog input 6	Ambient pressure
32	Analog input 7	Raw ADC calibration input
33	Analog input 8	Reserved
34	Analog input 9	Concentration data
35	Analog input 10	Reserved
36	Analog input 11	Reserved
37	Analog input 12	Raw analog to digital count for external analog input 0. 0-5V= 0-32766 A/D counts
38	Analog input 13	Raw analog to digital count for external analog input 1. 0-5V= 0-32766 A/D counts
39	Analog input 14	Raw analog to digital count for external analog input 2. 0-5V= 0-32766 A/D counts
40	Analog input 15	Reserved
41	CO Meas. Zero Pot (coarse)	S30 Measure ZERO coarse adjustment Pot
42	CO Meas. Zero Pot (fine)	S30 Measure ZERO fine adjustment Pot
43	SO2 Input Pot	SO2 Measure Signal Gain Pot
44	SO2 Ref. Gain Pot	SO2 Reference Signal Gain Pot
45	SO2 Meas. Zero Pot	SO2 Measure zero pot
46	O3 Input Pot	O3 Input signal gain pot
47	Diagnostic Test Pot	The Diagnostic mode adjustment pot for all the analysers except for S30
48	NOx Input Pot	PMT signal input gain control FOR NOx
49	PGA Gain	1, 2, 4, 8, 16, 32, 64, 128

50	Gas 1 Inst.	Primary gas concentration currently displayed on the front screen E.g. NO
51	Gas 2 Inst.	Secondary gas concentration currently displayed on front screen E.g. NOx
52	Gas 3 inst.	Calculated gas concentration currently displayed on front screen E.g. NO2
53	Gas 1 Avg.	Average of the readings (for Gas1) of the last n minutes where n is the averaging period
54	Gas 2 Avg.	Average of the readings (for Gas2) of the last n minutes where n is the averaging period
55	Gas 3 Avg.	Average of the readings (for Gas3) of the last n minutes where n is the averaging period
56	Instrument Gain	Current calibration value (default is 1.0)
57	Serial ID	Multidrop or Bayern-Hessen gas id
58	Bayern-Hessen ID	For multigas instruments only
59	Decimal Places	2-5
60	Noise	Instrument noise
61	Gas 1 Offset	An offset applied to Gas 1
62	Gas 3 Offset	An offset applied to Gas 3
63	Flow Temperature	Temperature of the flow block
64	Lamp Current	Lamp current in mA E.g 35mA
65	Digital Supply	Digital Supply voltage (should always read close to 5 volts)
66	Conc. Voltage	Concentration Voltage
67	High Voltage	High Voltage reading for PMT
68	Ozonator	0 = Off, 1 = On
69	Control Loop	0 = Off, 1 = On (default is On)
70	Diagnostic Mode	0 = Operate 1 = Preamp 2 = Electrical 3 = Optical (default is Operate)
71	Gas Flow	Units in slpm
72	Gas Pressure	Units in torr
73	Ambient Pressure	Units in torr
74	12V Supply	The 12 volt Power supply voltage
75	Cell Temperature	Cell Temperature
76	Conv. Temperature	Converter Temperature
77	Chassis Temperature	Chassis Temperature

78	Manifold Temp.	Manifold Temperature								
79	Cooler Temperature	Cooler Temperature								
80	Mirror Temperature	Mirror Temperature								
81	Lamp Temperature	Lamp Temperature								
82	IZS Lamp Temperature	O3 Lamp Temperature								
83	Instrument Status									
84	Reference Voltage	Units in Volts								
85	Calibration State	This variable has two different sets of values:								
		<table border="1"> <tr> <td>Set Calibration State</td> <td>Get IEEE Value</td> </tr> <tr> <td>0 = MEASURE</td> <td>0 = MEASURE</td> </tr> <tr> <td>1 = CYCLE</td> <td>1 = ZERO</td> </tr> <tr> <td>2 = ZERO</td> <td>2 = SPAN</td> </tr> <tr> <td>3 = SPAN</td> <td></td> </tr> </table>	Set Calibration State	Get IEEE Value	0 = MEASURE	0 = MEASURE	1 = CYCLE	1 = ZERO	2 = ZERO	2 = SPAN
Set Calibration State	Get IEEE Value									
0 = MEASURE	0 = MEASURE									
1 = CYCLE	1 = ZERO									
2 = ZERO	2 = SPAN									
3 = SPAN										
86	Primary Raw Conc.	(For S40, before NOx background and gain)								
87	Secondary Raw Conc.	Only for multigas instruments (For S40, before NOx background and gain)								
88	S40 Backgnd Conc.	NOx Background Concentration (For S40, before gain)								
89	Cal. Pressure	Calibration Pressure								
90	Conv. Efficiency	Converter Efficiency								
91	Multidrop Baud Rate	0 = 1200 bps 1 = 2400 bps 2 = 4800 bps 3 = 9600 bps 4 = 14400 bps 5 = 19200 bps 6 = 38400 bps								
92	Analog Range AO 1	Maximum range value for analog output								
93	Analog Range AO 2									
94	Analog Range AO 3									
95	Output Type AO 1	Output Type 1 = Voltage 0 = Current								
96	Output Type AO 2									
97	Output Type AO 3									
98	Anlg Ofst/Rng AO1	Voltage Offset /Current Range 0 = 0 % or 0-20mA 1 = 5 % or 2-20mA 2 = 10 % or 4-20mA								
99	Anlg Ofst/Rng AO2									
100	Anlg Ofst/Rng AO3									
101	F/Scale Volt AO 1	5.0 Volt Calibration value								
102	F/Scale Volt AO 2									

103	F/Scale Volt AO 3	
104	Z Adj Volt AO 1	0.5 Volt Calibration value
105	Z Adj Volt AO 2	
106	Z Adj Volt AO 3	
107	Negative Supply	Negative analog supply
108	Digital Outputs	A single byte expressing the most recent state of the digital outputs
109	Digital Inputs	A single byte expressing the most recent state of the digital inputs
110	Instrument State	0 = SAMPLE FILL 1 = SAMPLE MEASURE 2 = SAMPLE FILL AUX 3 = SAMPLE MEASURE AUX 4 = SAMPLE FILL AUX2 5 = SAMPLE MEASURE AUX2 6 = BACKGROUND FILL 7 = BACKGROUND MEASURE 8 = BACKGROUND PURGE 9 = BACKGROUND FILL AUX 10 = BACKGROUND MEASURE AUX 11 = ZERO FILL 12 = ZERO MEASURE 13 = ZERO FILL AUX 14 = ZERO MEASURE AUX 15 = ZERO FILL AUX2 16 = MEASURE AUX2 17 = BACKGROUND FILL ZERO 18 = BACKGROUND MEASURE ZERO 19 = SPAN FILL 20 = SPAN MEASURE 21 = SPAN FILL AUX 22 = SPAN MEASURE AUX 23 = SPAN FILL AUX2 24 = SPAN MEASURE AUX2 25 = BACKGROUND FILL SPAN 26 = BACKGROUND MEASURE SPAN 27 = BACKGROUND PURGE SPAN 28 = ELECTRONIC ZERO ADJUST 29 = INSTRUMENT WARM UP 30 = BACKGROUND ADJUST FILL 31 = BACKGROUND ADJUST MEASURE
111	CO Lin. Factor A	CO Linearisation Factor A
112	CO Lin. Factor B	CO Linearisation Factor B

113	CO Lin. Factor C	CO Linearisation Factor C
114	CO Lin. Factor D	CO Linearisation Factor D
115	CO Lin. Factor E	CO Linearisation Factor E
116	Instrument Units	0 = ppm 1 = ppb 2 = ppt 3 = mg/m ³ 4 = µg/m ³ 5 = ng/m ³ 6 = %
117	Backgnd Meas. Time	In seconds.
118	Sample Fill Time	These parameters can be changed, but only temporarily; restarting the instrument will restore them to their default values.
119	Sample Measure Time	
120	Aux Measure Time	
121	Aux Smpl. Fill Time	
122	Backgnd Fill Time	
123	Zero Fill Time	
124	Zero Measure Time	
125	Span Fill Time	
126	Span Measure Time	
127	O3 Gen Coeff D	O3 Generator Coefficient D
128	Backgnd Pause Time	In seconds
129	Bkgnd Intrleav Fact	
130	Cal. Pressure 2	Calibration Pressure for 2 nd gas
131	2nd Instrument Gain	Unused (always reports 1.0)
132	Background voltage	Units in Volts
133	Perm Rate	Permeation rate of the gas in ng/min
134	Perm Flow	Total flow past the permeation chamber during an activated internal span mode. In ml/min
135	Perm Oven Setpoint	Set target temperature for the permeation oven. Default is 50 °C
136	Perm Oven Temp	Temperature readout of the Permeation oven. Units in °C
137	Ozone Target	Ozone Target for S10 IZS ozone generation
138	Conc Adjusted 1	Concentration value in PPM before filtering
139	Conc Adjusted 2	
140	Conc Adjusted 3	
141	Reserved	

142	Reserved	
143	IR Source	The S30 IR source voltage
144	Background (hrs)	The background interval in hours. 0.0 if disabled 0.25 for every 15 minutes 0.30 for every 20 minutes 0.50 for every 30 minutes 1.00 for every hour ... 24.00 for once a day
145	Cycle Time	In minutes
146	CO Cooler Pot	CO Cooler voltage adjustment POT
147	CO Source Pot	CO Source voltage adjustment POT
148	CO Test Meas. Pot	Diagnostics use only
149	CO Test Ref. Pot	Diagnostics use only
150	O3 Ref Average	S10 Background Average
151	PTF Correction (gas 1)	Pressure Temperature Flow Compensation Factor for first gas
152	PTF Correction (gas 2)	Pressure Temperature Flow Compensation Factor for second gas in dual gas analysers.
153	Inst. Cell Pressure	Instantaneous cell pressure
154	Manifold	Manifold Pressure in S40 instruments
155	Cell Press. (gas1)	Cell Pressure for Gas 1
156	Cell Press. (gas2)	Cell Pressure for Gas 2
157	Cell Press. (Bgnd)	Cell Pressure when in Background
158	Background	0 = the instrument is measuring a gas sample 1 = the instrument is measuring background air
159	Gas To Measure	S51 only; see Measurement Settings Menu 0 = Measure both gasses 1 = Measure SO2 only 2 = Measure H2S only
160	Valve States	Diagnostic use only
161	Temperature Units	0 = "°C" 1 = "°F" 2 = "K"
162	Pressure Units	0 = "torr" 1 = "psi" 2 = "mbar" 3 = "atm" 4 = "kPa"

163	Averaging Period	0 = "1 Min" 1 = "3 Mins" 2 = "5 Mins" 3 = "10 Mins" 4 = "15 Mins" 5 = "30 Mins" 6 = "1 Hr" 7 = "4 Hrs" 8 = "8 Hrs" 9 = "12 Hrs" 10 = "24 Hrs"
164	Filter Type	0 = NO FILTER 1 = KALMAN FILTER 2 = 10 SEC FILTER 3 = 30 SEC FILTER 4 = 60 SEC FILTER 5 = 90 SEC FILTER 6 = 300 SEC FILTER 7 = ADPTIVE FILTER
165	NO2 Filter enabled	0 = Disabled, 1 = Enabled
166	Background Interval	0 = 24 Hrs 1 = 12 Hrs 2 = 8 Hrs 3 = 6 Hrs 4 = 4 Hrs 5 = 2 Hrs 6 = Disable
167	Service (COM1) Baud	Serial baud rate
168	Multidrop (COM2) Baud	0 = 1200 bps 1 = 2400 bps 2 = 4800 bps 3 = 9600 bps 4 = 14400 bps 5 = 19200 bps 6 = 38400 bps
169	Service Protocol	0 = EC9800
170	Multidrop Protocol	1 = Bayern-Hessen 2 = Advanced 3 = Modbus
171	AO1 Over Range	The Upper Concentration Range when Over-Ranging is enabled
172	AO2 Over Range	
173	AO3 Over Range	

174	AO1 Over-Ranging	0 = Over Ranging Disabled 1 = Over Ranging Enabled 2 = Over Ranging enabled and currently active
175	AO2 Over-Ranging	
176	AO3 Over-Ranging	
177	Heater Set Point	Cell Heater Set Point units in °C
178	PMT High Volt. Pot	High voltage pot setting
179	PMT Test LED Pot	PMT Test LED intensity controller POT
180	Last Power Failure	Time Stamp of the Last power fail (4 byte time stamp) Bit 31:26 ---- Year (0 – 99) Bit 25:22 ---- Month (1 – 12) Bit 21:17 ---- Date (1 – 31) Bit 16:12 ---- Hour (00 – 23) Bit 11:06 ---- Min (00 – 59) Bit 05:00 ---- Sec (00 – 59)
181	Inst Manifld Pres.	Manifold Pressure in S40 instruments (instantaneous)
182	Cell Press. (gas5)	Cell Pressure for Gas 5 (Nx)
183	Gas 4 Inst.	Calculated gas concentration currently displayed on front screen E.g. NH3
184	Gas 4 Avg.	Average of the readings (for Gas 4) of the last n minutes where n is the averaging period E.g. NH3
185	Gas 5 Inst.	Calculated gas concentration currently displayed on front screen E.g. Nx
186	NH3 Conv. Efficiency	
187	Cell/Lamp Duty Cycle	
188	Mirror T. Duty Cycle	
189	Flow Temp Duty Cycle	
190	Cooler T. Duty Cycle	
191	Conv Temp Duty Cycle	
192	CO Conv T Duty Cycle	
193	F/Scale Curr AO 1	20 mA Calibration value
194	F/Scale Curr AO 2	
195	F/Scale Curr AO 3	
196	Z Adj Curr AO 1	4 mA Calibration value
197	Z Adj Curr AO 2	
198	Z Adj Curr AO 3	
199	Ext Analog Input 1	The value of the external analog input after the multiplier and offset have been applied
200	Ext Analog Input 2	
201	Ext Analog Input 3	

202	Conv Set Point	Converter Set Point
203	Cal. Pressure 3	Calibration Pressure 3
204	PTF Correction (gas 3)	Pressure Temperature Flow Compensation Factor for third gas in multi-gas instruments.
205	Dilution Ratio	The current dilution ratio (default is 1.0)
206	Traffic Light	State of the status light: 0 = Green 1 = Amber 2 = Off (normally impossible) 3 = Red
207	Network Protocol	0 = EC9800 1 = Bayern-Hessen 2 = Advanced 3 = Modbus
208	Gas 4 Offset	A offset applied to Gas 4
209	O3 GEN Fine Pot	Ozone generator control, DAC controlled. DAC: 0..64535
210	O3 Gen Lamp Current	Units in mA
211	O3 GEN Coarse Pot	Repeat of parameter 209
212	Logging Period	The data logging period, in seconds (1.. 86400)
213	O3 Gen Coeff A	Ozone generator coefficients Note that Coeff D is parameter 127
214	O3 Gen Coeff B	
215	O3 Gen Coeff C	
216	Meas. Count	S60 measure count
217	Sig. Count 1	S60 signal counts in 90° steps
218	Sig. Count 2	
219	Sig. Count 3	
220	Sig. Count 4	
221	Signal Voltage	S60 Signal voltage
222	LED Drive	S60 LED drive value

This page is intentionally blank.

Appendix B. EC9800 Protocol

The Serinus implements a subset of the 9800 instrument protocol. Only the basic commands of reading the concentration value and setting the instrument calibration state (measure, span or zero) are supported.

B.1 Command Format

All commands are sent as ASCII strings. Fields are delimited by commas and the command ends with the normal return key (i.e. the TERMINATOR is either a <CR> or a <LF>). The DEVICE I.D. is the Serial ID assigned in the **Main Menu → Communications Menu → Serial Communication Menu**. If the instrument is not being used in a multi-drop connection, the DEVICE I.D> can be replaced with the string “???”.

B.2 Commands

B.2.1 DCONC

Function: Sends the current instantaneous concentration data to the serial port.
Format: DCONC, {<DEVICE I.D.>} {TERMINATOR}
Device response: {GAS} <SPACE> {STATUS WORD} <CR><LF>

The GAS value is the concentration value in the current instrument units, expressed as a floating point number (i.e. 12.345). The STATUS WORD indicates the instrument status in hex (i.e. A01F) using the following format:

Bit 15 = SYSFAIL (MSB)
Bit 14 = FLOWFAIL
Bit 13 = LAMPFAIL
Bit 12 = CHOPFAIL
Bit 11 = CVFAIL
Bit 10 = COOLERFAIL
Bit 9 = HEATERFAIL
Bit 8 = REFFAIL
Bit 7 = PS-FAIL
Bit 6 = HV-FAIL
Bit 5 = OUT OF SERVICE
Bit 4 = Instrument is in zero mode
Bit 3 = Instrument is in span mode
Bit 2 = Unused
Bit 1 = SET→PPM selected, CLEAR→MG/M3
Bit 0 = reserved (LSB)

B.2.2 DSPAN

Function: Commands the instrument to enter span mode.
Format: DSPAN, {<DEVICE I.D.>} {TERMINATOR}
Device response: <ACK> if the instrument is able to perform the command, <NAK> if not.

B.2.3 DZERO

Function: Commands the instrument to enter the zero mode.
Format: DZERO, {<DEVICE I.D.>} {TERMINATOR}
Device response: <ACK> if the instrument is able to perform the command, <NAK> if not.

B.2.4 ABORT

Function: Commands the instrument to abort the current span/zero mode and return to measure mode.
Format: ABORT, {<DEVICE I.D.>} {TERMINATOR}
Device response: <ACK> if the instrument is able to perform the command, <NAK> if not.

B.2.5 RESET

Function: Reboots the instrument (software reset).
Format: RESET, {<DEVICE I.D.>} {TERMINATOR}
Device response: <ACK>.

Appendix C. Bayern-Hessen Protocol

The Serinus implements a limited subset of the Bayern-Hessen Network protocol. Only the ability to set the instrument calibration state (measure, span or zero) and read the gas concentrations are supported.

C.1 Command Format

<STX><text><ETX>< bcc1><bcc2>

Where:

- <STX> ASCII Start of Text = 0x02 hex.
- <Text> ASCII text maximum length of 160 characters.
- <ETX> ASCII End of Text = 0x03 hex.
- <bcc1> ASCII representation of block check value MSB. (That is, the character “3” for 3, the character “F” for 15, etc.)
- <bcc2> ASCII representation of block check value LSB.

The block check algorithm begins with 0 and exclusive-OR’s each ASCII character from <STX> to <ETX> inclusive. This block check value is converted to ASCII format and sent after the <ETX> character.

Examples

This is an example of a valid Bayern-Hessen data request for an instrument that has a Serial ID of 97 (Serial ID assigned in the **Main Menu** → **Communications Menu** → **Serial Communication Menu**):

<STX>DA097<EXT>3A

The block check calculation is best shown by the following example:

Table 26 – Bayern-Hessen Data

Character	Hex Value	Binary	Block Check
<STX>	02	0000 0010	0000 0010
D	44	0100 0100	0100 0110
A	41	0100 0001	0000 0111
0	30	0011 0000	0011 0111
9	39	0011 1001	0000 1110
7	37	0011 0111	0011 1001
<ETX>	03	0000 0011	0011 1010

The binary value 0011 1010 corresponds to the hex value 3A. This value in ASCII forms the last two characters of the data request message.

Note: The I.D. of 97 is sent as the sequence 097. All I.D. strings must have three digits and must always be padded with ASCII zero characters.

This is an example of a valid command to put the unit in the manual span mode if the instrument has an ID of 843:

<STX>ST843 K<ETX>52

The block check operation is best shown with the following table:

Table 27 – Block Check Operation

Character	Hex Value	Binary	Block Check
<STX>	02	0000 0010	0000 0010
S	53	0101 0011	0101 0001
T	54	0101 0100	0000 0101
8	38	0011 1000	0011 1101
4	34	0011 0100	0000 1001
3	33	0011 0011	0011 1010
<SPACE>	20	0010 0000	0001 1010
K	4B	0100 1011	0101 0001
<ETX>	03	0000 0011	0101 0010

The binary block check value is 0101 0010 which is the hex value 52 as shown at the end of the command string.

C.2 Commands

C.2.1 DA

Return the current instantaneous concentration.

Command Format

<STX>{DA}{<kkk>}<ETX>< bcc1><bcc2>

Where:

kkk Device's ID. This field is optional, but if provided it must be padded with zeros to be 3 characters long. The value must match one of the following: the instrument's Bayern-Hessen ID, 000, or ??? (three question marks).

bcc1 First byte of the block check calculation.

bcc2 Second byte of the block check calculation.

Device response

The instrument responds with a variable length string, depending on how many measured gasses have been assigned an ID above 0. The text between the [] will be repeated once for each reported gas.

```
<STX>{MD}{cc}[<SP><kkk><SP><+nnnn+ee><SP><ss><SP><ff><SP><mmm><SP>eeeeee<SP>]<ETC><bcc1><bcc2>
```

Where:

<SP>	Space (0x20 hex).
cc	The number of gasses reported (0..5). The text in between the [] will be repeated once for each gas reported.
kkk	The Bayern-Hessen instrument ID.
+nnnn+ee	Gas concentration.
ss	Status byte (see table below for individual bits).
ff	Failure byte (see table below for individual bits).
mmm	Gas ID.
eeeeee	Ecotech instrument ID.
bcc1	First byte of the block check calculation.
bcc2	Second byte of the block check calculation.

Table 28 – Status Bit Map

Status Bit	Meaning if set to 1
0	Instrument off (this value is always set to 0).
1	Out of service.
2	Zero mode.
3	Span mode.
4	-
5	-
6	Units: 1 = Volumetric, 0 = Gravimetric.
7	Background mode (S30 and S50 family only).

Table 29 – Failure Bit Map (Positive Logic)

Failure Bit	Meaning if set to 1
0	Flow sensor failure.

Failure Bit	Meaning if set to 1
1	Instrument failure. Note that while the In Maintenance mode reports as an instrument failure with a red light on the front panel, for Bayern-Hessen this particular error is merely a status instead of a failure.
2	-
3	Lamp failure (S40 family only).
4	-
5	Cell heater failure (S30, S40 and S50 family only).
6	-
7	-

C.2.2 ST

Set the instrument mode.

Command Format

<STX>{ST}{< kkk>}<SP>{command}<ETC><bcc1><bcc2>

Where:

kkk	Device's Serial ID. This field is optional, but if provided it must be padded with zeros to be 3 characters long. The value must match one of the following: the instrument's Bayern-Hessen ID, 000, or ??? (three question marks).
Command	M, N or K for Measure, Zero or Span mode.
bcc1	First byte of the block check calculation.
bcc2	Second byte of the block check calculation.

Device response

The device does not issue a response to this command.

Appendix D. ModBus Protocol

The Serinus supports a limited Modbus implementation. The only function codes supported are 3 (read holding register) and 16 (write multiple registers). The Serial ID is assigned in the **Main Menu** → **Communications Menu** → **Serial Communication Menu**.

D.1 Command Format

<Slave address><Function code><Start register (MSB)><Start register (LSB)><Register count (MSB)><Register count (LSB)><Write byte count><Write data><CRC (MSB)><CRC (LSB)>

Where:

Slave address	The instrument Serial ID. If the request is being made via TCP, this field is omitted.
Function code	3 (read) or 16 (write).
Start register	Specifies an Advanced Protocol IEEE index (refer to Table 25 to see what values are available and what index to specify for them). The ModBus index is calculated from the Advanced Protocol index via the following formula: $\text{Modbus Index} = \text{Advanced Protocol Parameter List number} \times 2 + 256$
Register count	A single read command may request from 2 to 124 registers, which is to say from 1 to 62 values. The first index is specified by Start register; all following indexes are in sequential order. To read values that are not sequential requires using another read command. Note that the number of registers must be even, as each value is returned as a floating point value (4 bytes) and each register is a word (2 bytes). A write command can only write a single IEEE value at a time. Thus for write commands this value must be 2.
Write byte count	This field is only supplied for a write request; it indicates the amount of bytes of data that will follow, and must be set to 4 (since only one value can be written at a time).
Write data	This field is only supplied for a write request. It is the value to be written, expressed in IEEE format. The “Endian” structure can be selected on the Modbus Serial Communications menu. Big Endian means that the MSB byte of the IEEE value is at the right end of the four bytes; Little Endian means it is at the left.
CRC	Calculated by the standard Modbus CRC method. If the request is being made via TCP, this field is omitted.

D.2 Commands

D.2.1 Read Holding Registers

The response to a read request is in the following format:

<Slave address>3<Register count (MSB)><Register count (LSB)><Data><CRC (MSB)><CRC (LSB)>

Where:

Slave address	As general command format.
Register count	As general command format.
Data	4 to 248 bytes of data, representing 1 to 62 floating point numbers in IEEE format. The “Endian” structure can be selected on the Modbus Serial Communications menu. Big Endian means that the MSB byte of the IEEE value is at the right end of the four bytes; Little Endian means it is at the left.
CRC	As general command format.

D.2.2 Write Holding Register

The only supported use for this command is to set the instrument into a calibration state.

Where:

Start register MSB	1
Start register LSB	170
Register count	2
Write Data bytes	The IEEE representation of 0, 1, 2, or 3 0 puts the instrument into Measure mode (0,0,0,0) 1 puts the instrument into Cycle mode (63,128,0,0) 2 puts the instrument into Zero mode (64,0,0,0) 3 puts the instrument into Span mode (64,64,0,0)

The response to a write request is to return the first six bytes of the initiating write request.

D.2.3 Error

An error will be returned in the following format:

<Slave address><Function code><Exception code><CRC (MSB)><CRC (LSB)>

Slave address	As general command format.
Function code	The initiating command’s function code + 128; so either 131 (read) or 144 (write).
Exception code	The error code (see table below).

CRC As general command format.

Table 30 – Modbus Error Codes

Value	Error
1	Illegal Function
2	Illegal Data Address
3	Illegal Data Value
4	Slave Device Failure



1492 Ferntree Gully Road,
Knoxfield, VIC Australia 3180
Phone: +61 (0)3 9730 7800
Fax: +61 (0)3 9730 7899
General email: info@ecotech.com
Support: support@ecotech.com
www.ecotech.com